



**AUSSIE ADAPTORS
& HYDRAULICS P/L**

CATALOGUE 2023

CONTENTS

STRAIGHT

Nipple

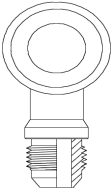
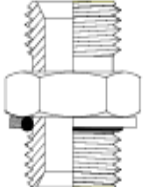
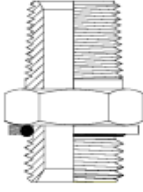
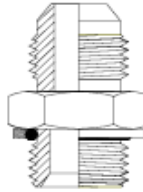
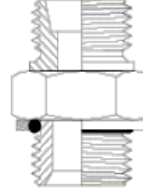
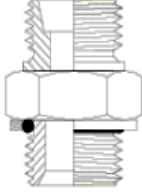
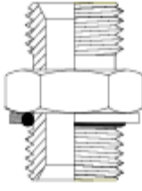
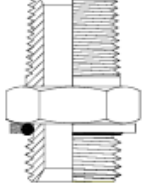
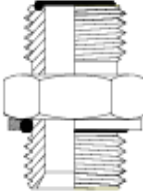
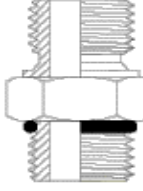
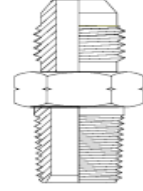
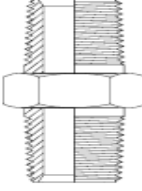
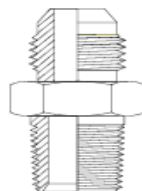
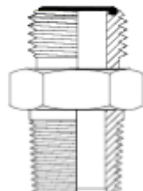
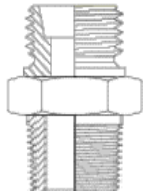
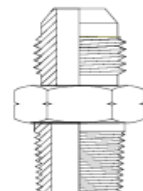
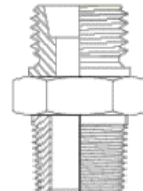
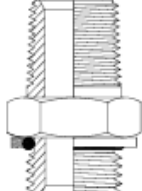
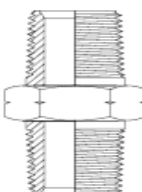
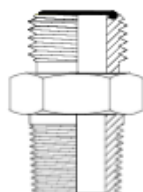
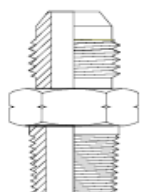
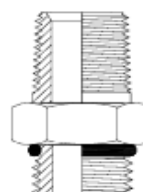
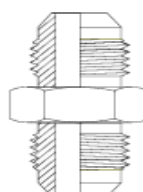
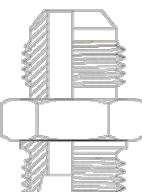
| | | | | | |
|---|---|---|---|---|---|
| BBJ-JIM | BPM-BPM | BPM-BTM | BPM-JIM | BPM-MHM | BPM-MLM |
|  |  |  |  |  |  |
| BSP Banjo JIC Male | BSPP Male BSPP Male | BSPP Male BSPT Male | BSPP Male JIC Male | BSPP Male Metric Heavy Male | BSPP Male Metric Light Male |
| Page 2 | Page 2 | Page 3 | Page 4 | Page 58 | Page 58 |
| BPM-MSM | BPM-NTM | BPM-ORM | BPM-UNM | BTM-BJM | BTM-BTM |
|  |  |  |  |  |  |
| BSPP Male Metric Stud Male | BSPP Male NPT Male | BSPP Male ORFS Male | BSPP Male UNO Male | BSPT Male JIS BSP Male | BSPT Male BSPT Male |
| Page 5 | Page 5 | Page 5 | Page 6 | Page 7 | Page 9 |
| BTM-JIM | BTM-MCM | BTM-MHM | BTM-MKM | BTM-MLM | BTM-MSM |
|  |  |  |  |  |  |
| BSPT Male JIC Male | BSPT Male Metric Flat Face Male | BSPT Male Metric Heavy Male | BSPT Male JIS Komatsu Male | BSPT Male Metric Light Male | BSPT Male Metric Stud Male |
| Page 10 | Page 11 | Page 59 | Page 11 | Page 59 | Page 11 |
| BTM-NTM | BTM-ORM | BTM-SAM | BTM-UNM | JIM-JIM | JIM-MHM |
|  |  |  |  |  |  |
| BSPT Male NPT Male | BSPT Male ORFS Male | BSPT Male SAE Male | BSPT Male UNO Male | JIC Male JIC Male | JIC Male Metric Heavy Male |
| Page 11 | Page 12 | Page 12 | Page 13 | Page 16 | Page 60 |

All Prices Exclude GST

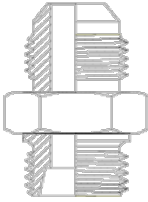
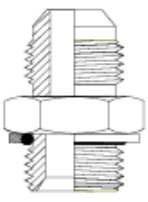
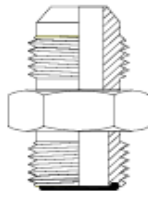
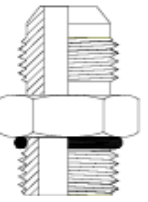
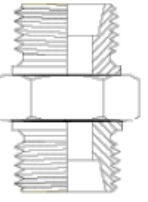
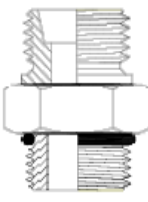
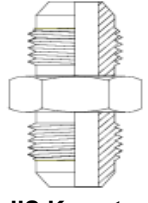
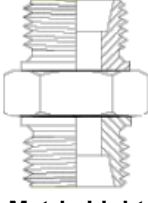
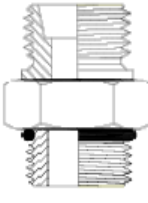
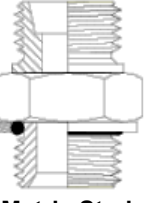
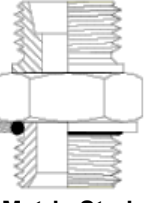
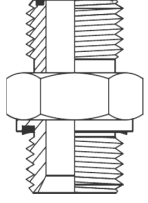
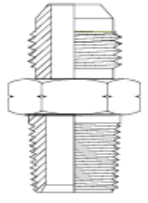
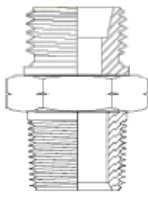
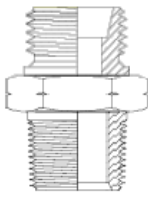
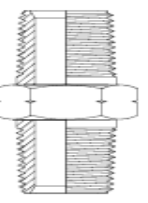
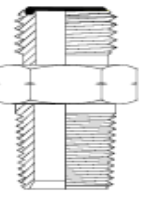
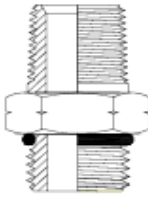
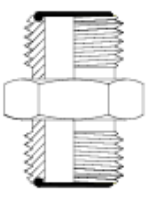
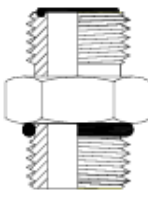

CONTENTS

| | | | | | |
|---|---|---|---|--|---|
| JIM-MLM | JIM-MSM | JIM-ORM | JIM-UNM | MHM-MHM | MHM-UNM |
|  |  |  |  |  |  |
| JIC Male Metric Light Male | JIC Male Metric Stud Male | JIC Male ORFS Male | JIC Male UNO Male | Metric Heavy Male Metric Heavy Male | Metric Heavy Male UNO Male |
| Page 60 | Page 16 | Page 17 | Page 18 | Page 62 | Page 67 |
| MKM-MKM | MLM-MLM | MLM-UNM | MSM-MHM | MSM-MLM | MSM-ORM |
|  |  |  |  |  |  |
| JIS Komatsu Male | Metric Light Male Metric Light Male | Metric Light Male UNO Male | Metric Stud Male Metric Heavy Male | Metric Stud Male Metric Light Male | Metric Stud Male ORFS Male |
| Page 19 | Page 62 | Page 67 | Page 66 | Page 66 | Page 22 |
| NTM-JIM | NTM-MHM | NTM-MLM | NTM-NTM | NTM-ORM | NTM-UNM |
|  |  |  |  |  |  |
| NPT Male JIC Male | NPT Male Metric Heavy Male | NPT Male Metric Light Male | NPT Male NPT Male | NPT Male ORFS Male | NPT Male UNO Male |
| Page 20 | Page 68 | Page 68 | Page 21 | Page 22 | Page 22 |
| ORM-ORM | ORM-UNM | | | | |
|  |  | | | | |
| ORFS Male ORFS Male | ORFS Male UNO Male | | | | |
| Page 23 | Page 23 | | | | |

All Prices Exclude GST

CONTENTS

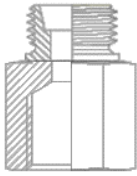
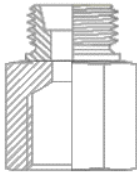
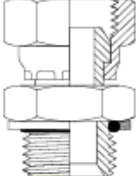
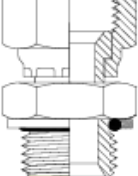
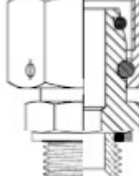
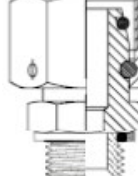
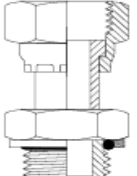
Adaptor Union

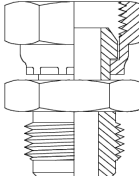
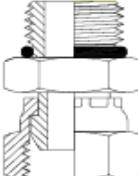
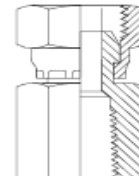
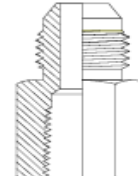
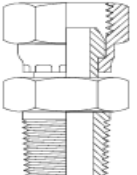
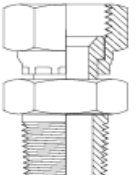
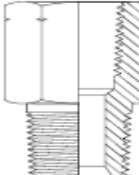
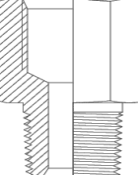
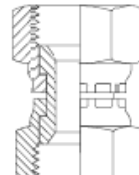
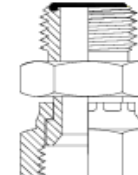
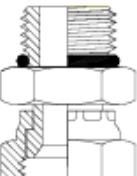
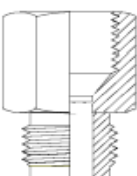
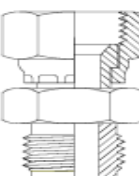
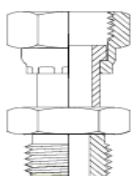
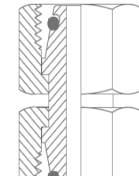
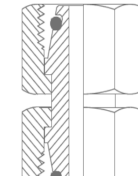
| | | | | | |
|---|---|---|--|---|---|
| BPF-MHM | BPF-MLM | BPM-BSF | BPM-JIF | BPM-MHF | BPM-MLF |
|  |  |  |  |  |  |
| BSPP Female Metric Heavy Male Page 56 | BSPP Female Metric Light Male Page 56 | BSPP Male BSPP Female Swivel Page 3 | BSPP Male JIC Female Swivel Page 4 | BSPP Male Metric Heavy Female Swivel Page 57 | BSPP Male Metric Light Female Swivel Page 57 |
| BPM-ORF | BSF-BSF | BSF-JIM | BSF-UNM | BTF-BSF | BTF-JIM |
|  |  |  |  |  |  |
| BSPP Male ORFS Female Swivel Page 5 | BSPP Female Swivel BSPP Female Swivel Page 6 | BSPP Female Swivel JIC Male Page 6 | BSPP Female Swivel UNO Male Page 6 | BSPT Female Fixed BSPP Female Swivel Page 7 | BSPT Female Fixed JIC Male Page 7 |
| BTM-BSF | BTM-JIF | BTM-NTF | BTM-UNF | JIF-JIF | JIF-ORM |
|  |  |  |  |  |  |
| BSPT Male BSPP Female Swivel Page 8 | BSPT Male JIC Female Swivel Page 9 | BSPT Male NPT Female Fixed Page 11 | BSPT Male UNO Female Fixed Page 12 | JIC Female Swivel JIC Female Swivel Page 13 | JIC Female Swivel ORFS Male Page 13 |
| JIF-UNM | JIM-JFF | JIM-JIF | JIM-ORF | MHF-MHF | MLF-MLF |
|  |  |  |  |  |  |
| JIC Female Swivel UNO Male Page 14 | JIC Male JIC Female Fixed Page 15 | JIC Male JIC Female Swivel Page 15 | JIC Male ORFS Female Swivel Page 17 | Metric Heavy Female Swivel Metric Heavy Female Swivel Page 61 | Metric Light Female Swivel Metric Light Female Swivel Page 61 |

All Prices Exclude GST

CONTENTS

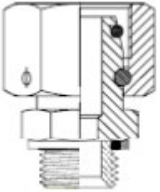
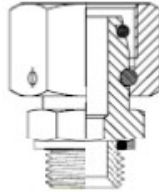
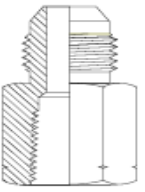
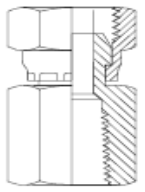
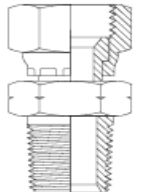
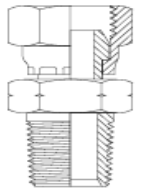
| MSM-MHF | MSM-MLF | NTF-JIM | NTF-NSF | NTM-JIF | NTM-NSF |
|---|---|---|---|---|---|
|  |  |  |  |  |  |
| Metric Stud Male Metric Heavy Female Swivel Page 65 | Metric Stud Male Metric Heavy Female Swivel Page 65 | NPT Female Fixed JIC Male Page 19 | NPT Female Fixed NPT Female Swivel Page 19 | NPT Male JIC Female Swivel Page 19 | NPT Male NPT Female Swivel Page 20 |

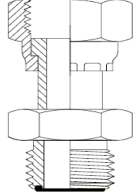
| ORM-ORF |
|--|
|  |
| ORFS Male ORFS Female Swivel Page 22 |

Tubeweld

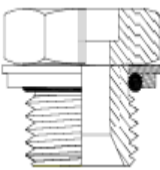
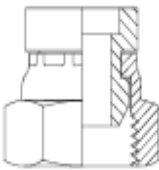
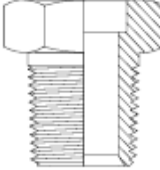
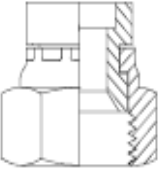
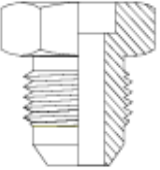
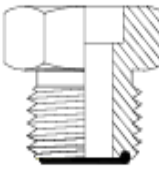
| BPM-TWF | BSF-TWF | BTM-TWF | JIF-TWF | JIM-TWF | ORM-TWF |
|---|---|---|---|--|---|
|  |  |  |  |  |  |
| BSPP Male Tubeweld Page 5 | BSPP Female Swivel Tubeweld Page 6 | BSPT Male Tubeweld Page 12 | JIC Female Swivel Tubeweld Page 13 | JIC Male Tubeweld Page 17 | ORFS Male Tubeweld Page 23 |

All Prices Exclude GST

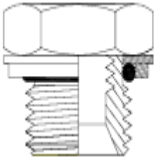
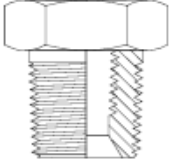
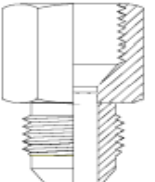
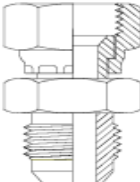
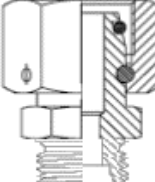
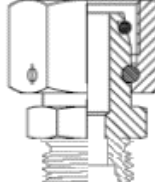

CONTENTS

Reducer / Expander

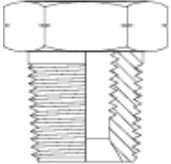
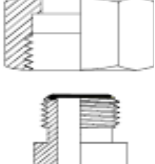
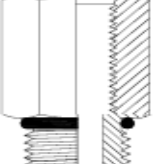
| BPM-BPF | BTM-BTF | JIM-JFF | JIM-JIF | MHM-MHF | MLM-MLF |
|---|---|---|--|---|---|
|  |  |  |  |  |  |
| BSPP Male BSPP Female | BSPT Male BSPT Female | JIC Male JIC Female Fixed | JIC Male JIC Female Swivel | Metric Heavy Male Metric Heavy Female Swivel | Metric Light Male Metric Light Female Swivel |
| Page 2 | Page 8 | Page 15 | Page 15 | Page 63 | Page 64 |

| NTM-NTF | ORM-ORF | UNM-UNF |
|--|--|--|
|  |  |  |
| NPT Male NPT Female | ORFS Male ORFS Female | UNO Male UNO Female |
| Page 21 | Page 22 | Page 24 |

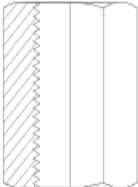
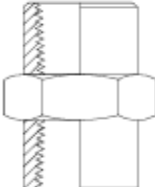
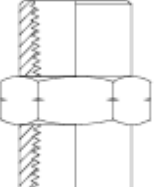
Socket

| BPF-BPF | BTF-BTF | NTF-NTF | UNF-UNF |
|---|---|---|--|
|  |  |  |  |
| BSPP Female BSPP Female | BSPT Female BSPT Female | NPT Female NPT Female | UNO Female UNO Female |
| Page 3 | Page 7 | Page 19 | Page 24 |

All Prices Exclude GST

CONTENTS

45 DEGREE

BPM-BTM-45C

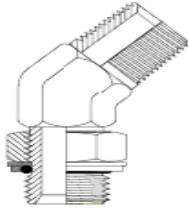

**BSPP Male
BSPT Male**

Page 26

BPM-JIM-45C

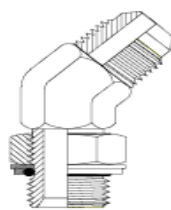

**BSPP Male
JIC Male**

Page 26

BPM-ORM-45C

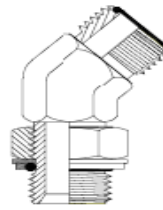

**BSPP Male
ORFS Male**

Page 26

BTF-BTF-45C

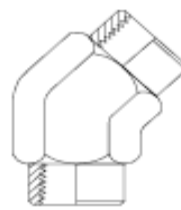

**BSPT Female
BSPT Female
Fixed**

Page 26

BTM-BSF-45C

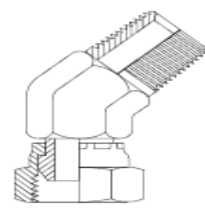

**BSPT Male
BSPP Female
Swivel**

Page 26

BTM-BTF-45C

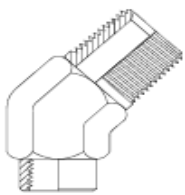

**BSPT Male
BSPT Female
Fixed**

Page 27

BTM-BTM-45C

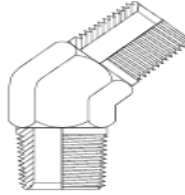

**BSPT Male
BSPT Male**

Page 27

BTM-JIM-45C

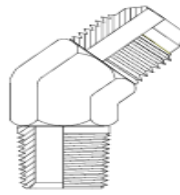

**BSPT Male
JIC Male**

Page 27

JIM-JIF-45C

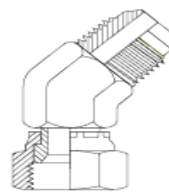

**JIC Male
JIC Female
Swivel**

Page 28

JIM-JIM-45C

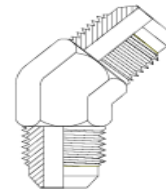

**JIC Male
JIC Male**

Page 28

JIM-UNM-45C

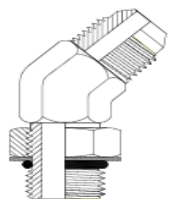

**JIC Male
UNO Male**

Page 28

NTM-JIM-45C

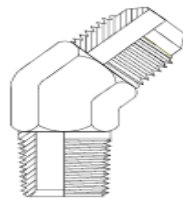

**NPT Male
JIC Male**

Page 29

NTM-NSF-45C

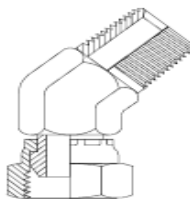

**NPT Male
NPT Female
Swivel**

Page 29

NTM-NTF-45C

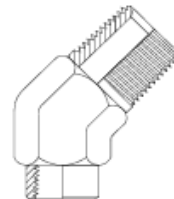

**NPT Male
NPT Female
Fixed**

Page 29

NTM-NTM-45C

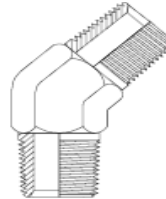

**NPT Male
NPT Male**

Page 29

ORM-ORF-45C

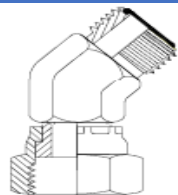

**ORFS Male
ORFS Female
Swivel**

Page 30

ORM-UNM-45C

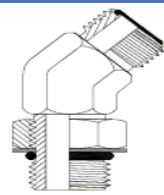

**ORFS Male
UNO Male**

Page 30

All Prices Exclude GST

CONTENTS

90 DEGREE

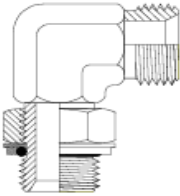
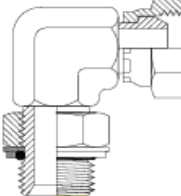
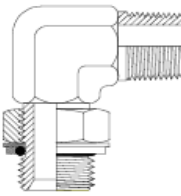
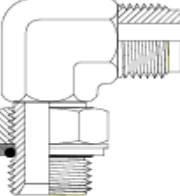
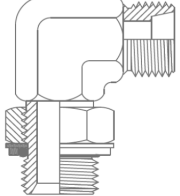
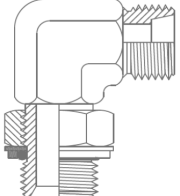
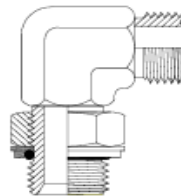
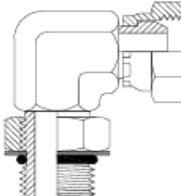
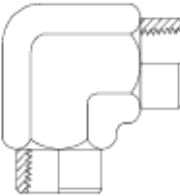
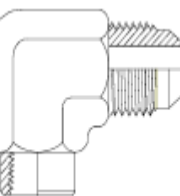
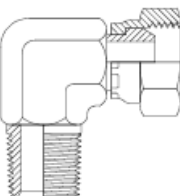
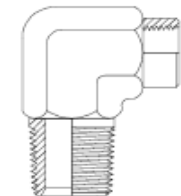
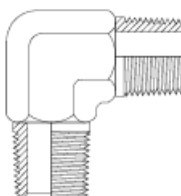
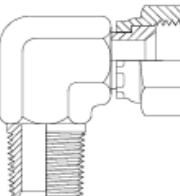
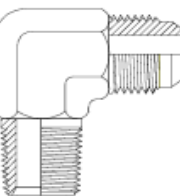
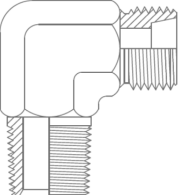
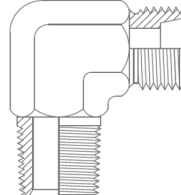
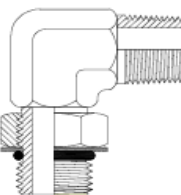
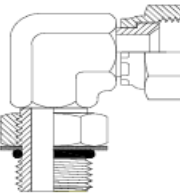
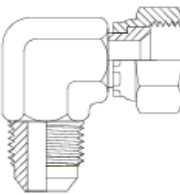
| | | | | |
|---|---|---|--|---|
| BPM-BPM-90C | BPM-BSF-90C | BPM-BTM-90C | BPM-JIM-90C | BPM-MHM-90C |
|  |  |  |  |  |
| BSPP Male BSPP Male Page 31 | BSPP Male BSPP Female Swivel Page 31 | BSPP Male BPST Male Page 31 | BSPP Male JIC Male Page 32 | BSPP Male Metric Heavy Male Page 70 |
| BPM-MLM-90C | BPM-ORM-90C | BSF-UNM-90C | BTF-BTF-90C | BTF-JIM-90C |
|  |  |  |  |  |
| BSPP Male Metric Light Male Page 70 | BSPP Male ORFS Male Page 32 | BSPP Female Swivel UNO Male Page 32 | BSPT Female BSPT Female Fixed Page 33 | BSPT Female Fixed JIC Male Page 33 |
| BTM-BSF-90C | BTM-BTF-90C | BTM-BTM-90C | BTM-JIF-90C | BTM-JIM-90C |
|  |  |  |  |  |
| BSPT Male BSPP Female Swivel Page 33 | BSPT Male BSPT Female Fixed Page 33 | BSPT Male BSPT Male Page 34 | BSPT Male JIC Female Swivel Page 34 | BSPT Male JIC Male Page 34 |
| BTM-MHM-90C | BTM-MLM-90C | BTM-UNM-90C | JIF-UNM-90C | JIM-JIF-90C |
|  |  |  |  |  |
| BSPT Male Metric Heavy Male Page 71 | BSPT Male Metric Light Male Page 71 | BSPT Male UNO Male Page 35 | JIC Female Swivel UNO Male Page 35 | JIC Male JIC Female Swivel Page 36 |

All Prices Exclude GST

CONTENTS

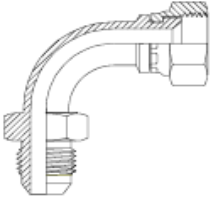
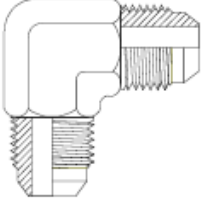
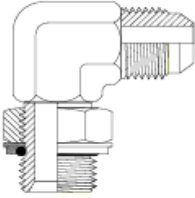
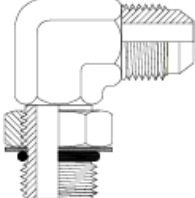
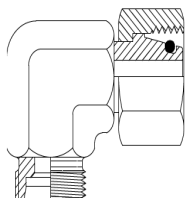
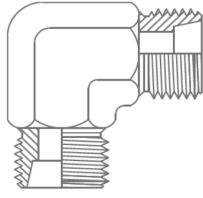
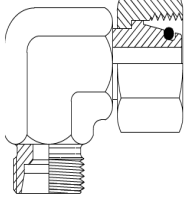
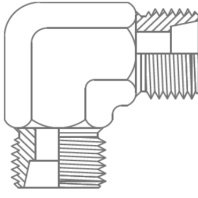
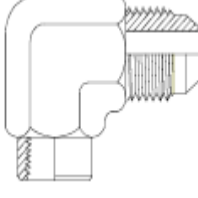
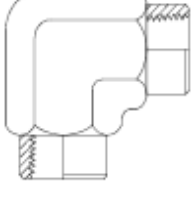
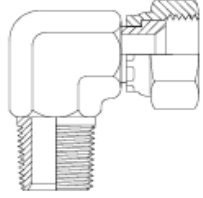
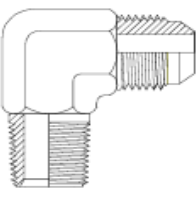
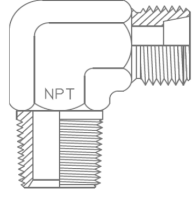
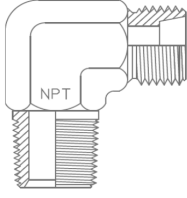
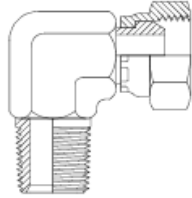
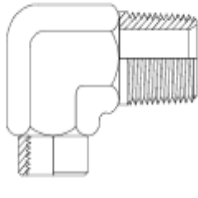
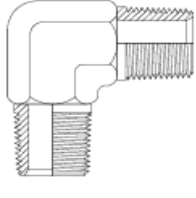
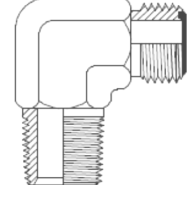
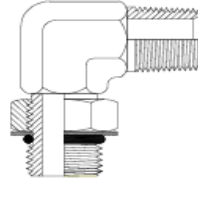
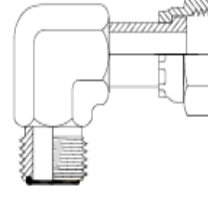
| | | | | |
|---|---|---|--|---|
| JIM-JIF-90S | JIM-JIM-90C | JIM-MSM-90C | JIM-UNM-90C | MHM-MHF-90C |
|  |  |  |  |  |
| JIC Male JIC Female Swivel Page 36 | JIC Male JIC Male Page 37 | JIC Male Metric Stud Male Page 37 | JIC Male UNO Male Page 37 | Metric Heavy Male Metric Heavy Female Swivel Page 72 |
| MHM-MHM-90C | MLM-MLF-90C | MLM-MLM-90C | NTF-JIM-90C | NTF-NTF-90C |
|  |  |  |  |  |
| Metric Heavy Male Metric Heavy Male Page 72 | Metric Light Male Metric Light Female Swivel Page 72 | Metric Light Male Metric Light Male Page 72 | NPT Female Fixed JIC Male Page 38 | NPT Female NPT Female Fixed Page 38 |
| NTM-JIF-90C | NTM-JIM-90C | NTM-MHM-90C | NTM-MLM-90C | NTM-NSF-90C |
|  |  |  |  |  |
| NPT Male JIC Female Swivel Page 38 | NPT Male JIC Male Page 38 | NPT Male Metric Heavy Male Page 73 | NPT Male Metric Light Male Page 73 | NPT Male NPT Female Swivel Page 39 |
| NTM-NTF-90C | NTM-NTM-90C | NTM-ORM-90C | NTM-UNM-90C | ORM-ORF-90C |
|  |  |  |  |  |
| NPT Male NPT Female Fixed Page 39 | NPT Male NPT Male Page 39 | NPT Male ORFS Male Page 39 | NPT Male UNO Male Page 39 | ORFS Male ORFS Female Swivel Page 40 |

All Prices Exclude GST

CONTENTS

ORM-ORM-90C

ORM-UNM-90C

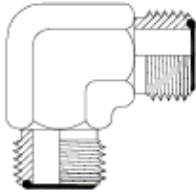

ORFS Male
ORFS Male

Page 40

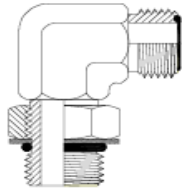

ORFS Male
UNO Male

Page 40

CONTENTS

BULKHEAD

Straight

BPM-BBM

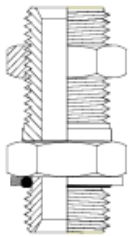

**BSPP Male
BSPP Male**

Page 41

BPM-JBM

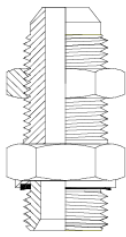

**BSPP Male
JIC Male**

Page 41

JIM-JBM

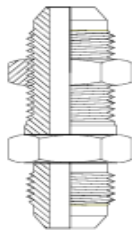

**JIC Male
JIC Male**

Page 41

MHM-MBM

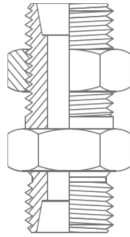

**Metric Heavy
Male
Metric Heavy
Male**

Page 69

MLM-MBM

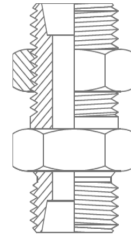

**Metric Light
Male
Metric Light
Male**

Page 69

NTF-JBM

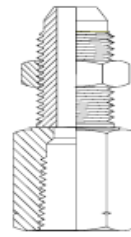

**NPT Female
Fixed
JIC Male**

Page 41

NTM-JBM

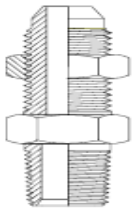

**NPT Male
JIC Male**

Page 41

ORM-OBM

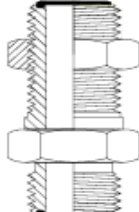

**ORFS Male
ORFS Male**

Page 42

45 Degree

JIM-JBM-45C

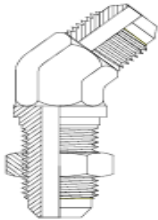

**JIC Male
JIC Male**

Page 42

ORM-OBM-45C

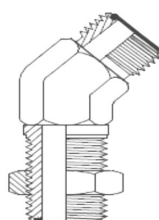

**ORFS Male
ORFS Male**

Page 42

All Prices Exclude GST

CONTENTS

90 Degree

JIM-JBM-90C

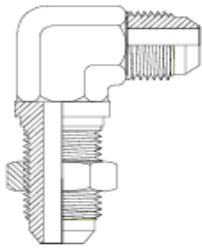

JIC Male
JIC Male

Page 42

MHM-MBM-90C

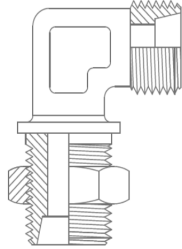

Metric Heavy Male
Metric Heavy Male

Page 69

MLM-MBM-90C

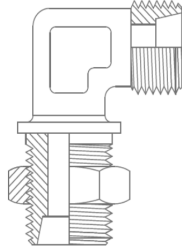

Metric Light Male
Metric Light Male

Page 69

ORM-OBM-90C

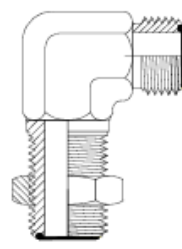

ORFS Male
ORFS Male

Page 42

Tee

JIM-JBM-JIM

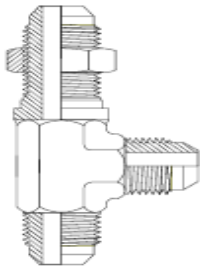

JIC Male
JIC Male
JIC Male

Page 43

JIM-JIM-JBM

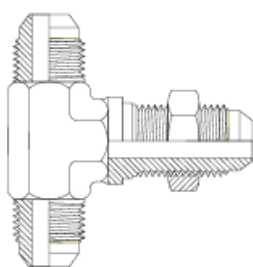

JIC Male
JIC Male
JIC Male

Page 43

ORM-OBM-ORM

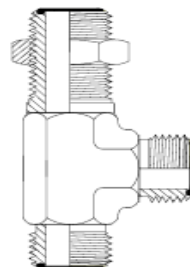

ORFS Male
ORFS Male
ORFS Male

Page 43

All Prices Exclude GST

CONTENTS

TEE

BPF-BPF-BPF

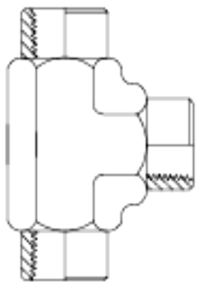

**BSPP Female
BSPP Female
BSPP Female
Fixed
Page 44**

BPM-JIM-JIM

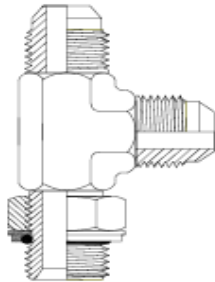

**BSPP Male
JIC Male
JIC Male
Page 44**

BTF-BTF-BTF

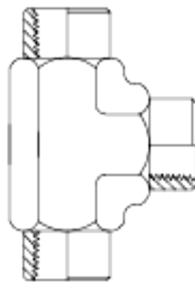

**BSPT Female
BSPT Female
BSPT Female
Fixed
Page 44**

BTM-BSF-BTM

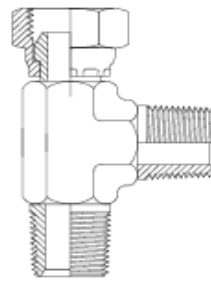

**BSPT Male
BSPP Female
Swivel
BSPT Male
Page 44**

BTM-BTF-BTF

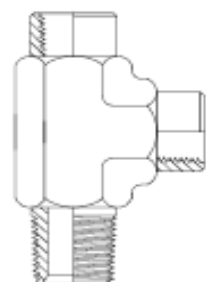

**BSPT Male
BSPT Female
BSPT Female
Fixed
Page 44**

BTM-BTM-BSF

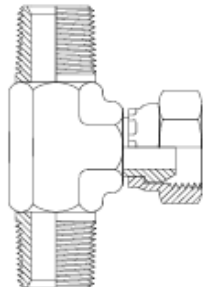

**BSPT Male
BSPT Male
BSPP Female
Swivel
Page 45**

BTM-BTM-BTM

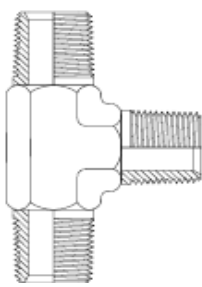

**BSPT Male
BSPT Male
BSPT Male
Page 45**

BTM-JIM-JIM

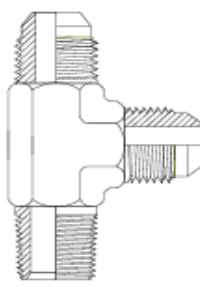

**BSPT Male
JIC Male
JIC Male
Page 45**

JIM-JIF-JIM

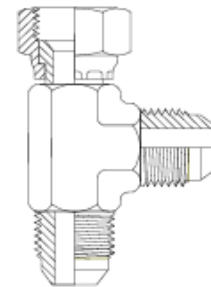

**JIC Male
JIC Female Swivel
JIC Male
Page 45**

JIM-JIM-BPM

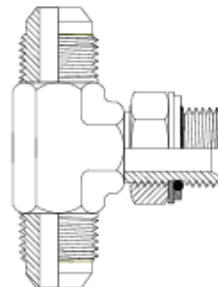

**JIC Male
JIC Male
BSPP Male
Page 45**

JIM-JIM-BTM

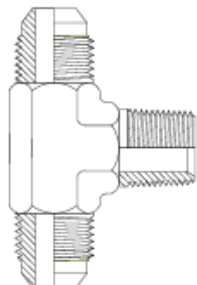

**JIC Male
JIC Male
BSPT Male
Page 46**

JIM-JIM-JIF

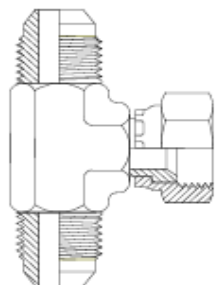

**JIC Male
JIC Male
JIC Female Swivel
Page 46**

JIM-JIM-JIM

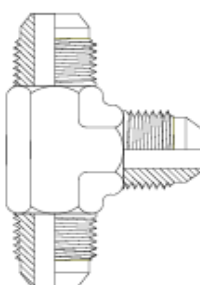

**JIC Male
JIC Male
JIC Male
Page 46**

JIM-JIM-NTM

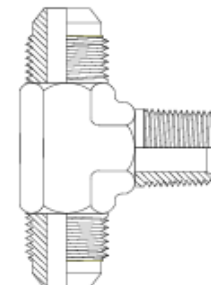

**JIC Male
JIC Male
NPT Male
Page 46**

JIM-JIM-UNM

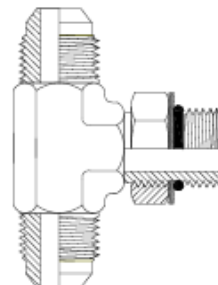

**JIC Male
JIC Male
UNO Male
Page 47**

All Prices Exclude GST

CONTENTS

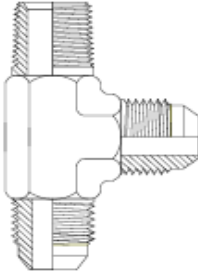
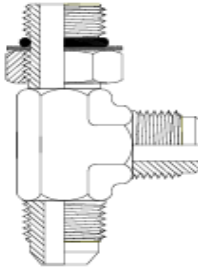
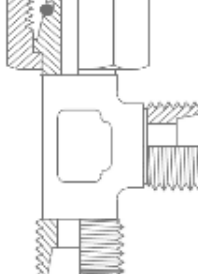
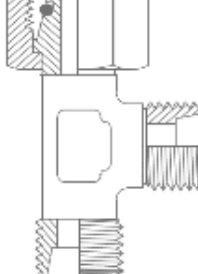
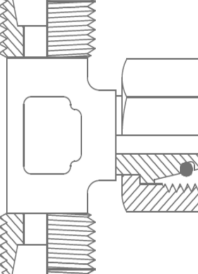
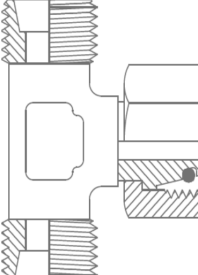
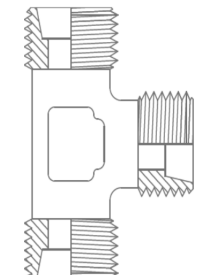
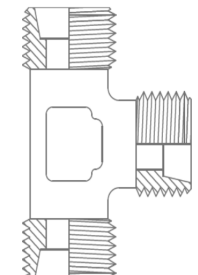
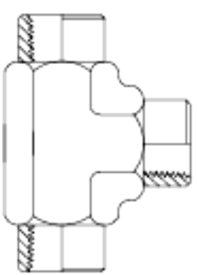
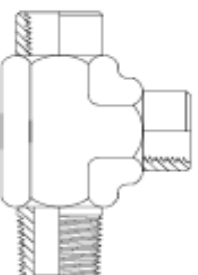
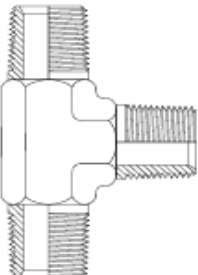
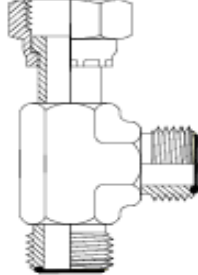
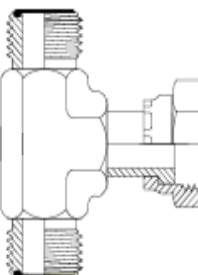
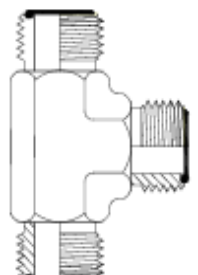
| JIM-NTM-JIM | JIM-UNM-JIM | MHM-MHF-MHM | MLM-MLF-MLM | MHM-MHM-MHF |
|---|---|---|--|--|
|  |  |  |  |  |
| JIC Male NPT Male JIC Male Page 47 | JIC Male UNO Male JIC Male Page 47 | Metric Heavy Male Metric Heavy Female Swivel Metric Heavy Male Page 74 | Metric Light Male Metric Light Female Swivel Metric Light Male Page 74 | Metric Heavy Male Metric Heavy Male Metric Heavy Female Swivel Page 74 |
| MLM-MLM-MLF | MHM-MHM-MHM | MLM-MLM-MLM | NTF-NTF-NTF | NTM-NTF-NTF |
|  |  |  |  |  |
| Metric Light Male Metric Light Male Metric Light Female Swivel Page 74 | Metric Heavy Male Metric Heavy Male Metric Heavy Male Page 75 | Metric Light Male Metric Light Male Metric Light Male Page 75 | NPT Female NPT Female NPT Female Fixed Page 47 | NPT Male NPT Female NPT Female Fixed Page 48 |
| NTM-NTM-NTM | ORM-ORF-ORM | ORM-ORM-ORF | ORM-ORM-ORM | |
|  |  |  |  | |
| NPT Male NPT Male NPT Male Page 48 | ORFS Male ORFS Female Swivel ORFS Male Page 48 | ORFS Male ORFS Male ORFS Female Swivel Page 48 | ORFS Male ORFS Male ORFS Male Page 48 | |

All Prices Exclude GST

CONTENTS

TEST PORT TEE

BTM-BSF-BPF

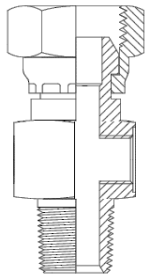

**BSPT Male
BSPP Female
Swivel
BSPP Female
Page 49**

JIM-JIF-BPF

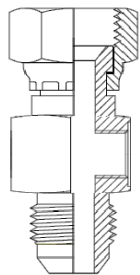

**JIC Male
JIC Female Swivel
BSPP Female
Page 49**

ORM-ORF-BPF

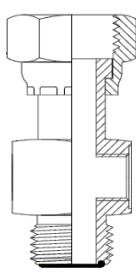

**ORFS Male
ORFS Female
Swivel
BSPP Female
Page 49**

MLM-MLF-BPF

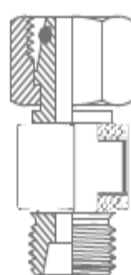

**Metric Light Male
Metric Light
Female Swivel
BSPP Female
Page 49**

CROSS

BTF-BTF-BTF-BTF

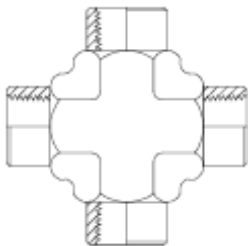

**BSPT Female
BSPT Female
BSPT Female
BSPT Female
Page 49**

JIM-JIM-JIM-JIM

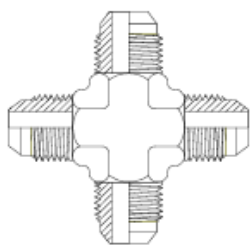

**JIC Male
JIC Male
JIC Male
JIC Male
Page 49**



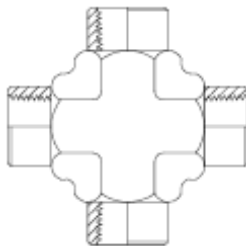

NTF-NTF-NTF-NTF





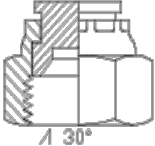

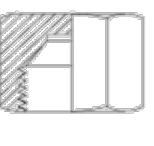
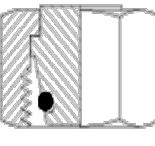
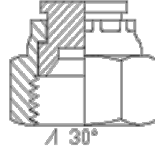
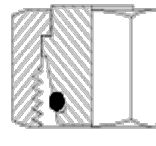

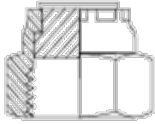
**NPT Female
NPT Female
NPT Female
NPT Female
Page 49**

CONTENTS

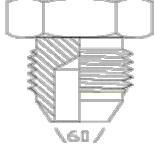
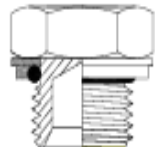
CAPS

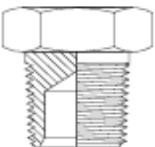
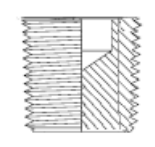
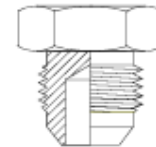
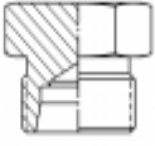
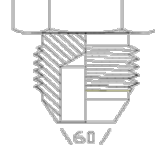
| BJF | BSF | JIF | MHF | MKF | MLF |
|---|---|---|--|---|---|
|  |  |  |  |  |  |
| JIS (BSP) Cap Page 50 | BSPP Cap Page 50 | JIC Cap Page 51 | Metric Heavy Cap Page 76 | JIS (Komatsu) Cap Page 52 | Metric Light Cap Page 76 |
| NTF | ORF | | | | |
|  |  | | | | |
| NPT Cap Page 53 | ORFS Cap Page 53 | | | | |

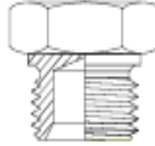
PLUGS

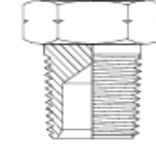
| BJM | BPM | BPM-CS | BTM | BTM-CS | JIM |
|---|---|---|--|---|---|
|  |  |  |  |  |  |
| JIS (BSP) Plug Page 50 | BSPP Plug Page 50 | BSPP In Hex Plug Page 50 | BSPT Plug Page 51 | BSPT In Hex Plug Page 51 | JIC Plug Page 51 |
| MHM | MKM | MLM | MSM | MSM-CS | NTM |
|  |  |  |  |  |  |
| Metric Heavy Plug Page 76 | JIS (Komatsu) Plug Page 52 | Metric Light Plug Page 76 | Metric Plug Page 52 | Metric In Hex Plug Page 52 | NPT Plug Page 53 |

All Prices Exclude GST

CONTENTS

ORM



ORFS Plug
Page 53

UNM

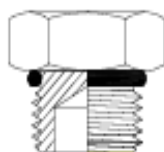

UNO Plug
Page 53

UNM-CS



UNO In Hex Plug
Page 53

PLASTIC CAPS & PLUGS

PCB

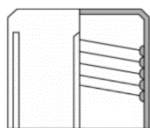

BSPP Plastic Cap
Page 54

PCJ

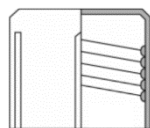

JIC Plastic Cap
Page 54

PCO

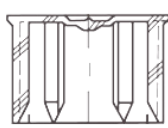

ORFS Plastic Cap
Page 54

PPB

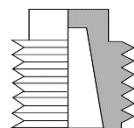

BSPP Plastic Plug
Page 54

PPJ

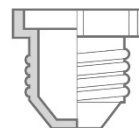

JIC Plastic Plug
Page 54

PPO

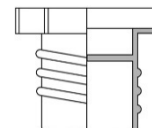

ORFS Plastic Plug
Page 54

FLANGE ADAPTORS

Straight

CLS-F61

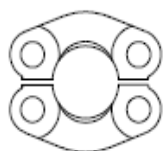

Code 61 Split Flange Clamp
Page 130

CLS-F62

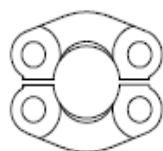

Code 62 Split Flange Clamp
Page 130

F61-PLATE

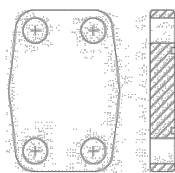

Code 61 Flange Blanking Plate
Page 130

F62-PLATE

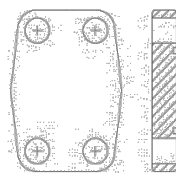

Code 62 Flange Blanking Plate
Page 130

F61-PLUG



Code 61 Flange Plug
Page 51

F62-PLUG



Code 62 Flange Plug
Page 51

All Prices Exclude GST

CONTENTS

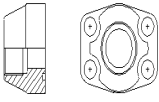
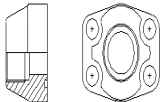
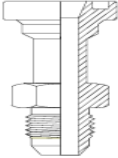
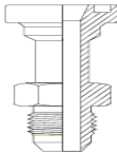
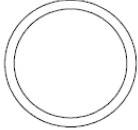
| FB-F61 | FB-F62 | JIM-F61 | JIM-F62 | CAT-F62 |
|---|---|---|--|---|
|  |  |  |  |  |
| Code 61 Flange Block BSPP Female Page 130 | Code 62 Flange Block BSPP Female Page 130 | JIC Male Code 61 Flange Page 14 | JIC Male Code 62 Flange Page 14 | Code 62 Flange CAT Spacer Ring Page 130 |

45 Degree

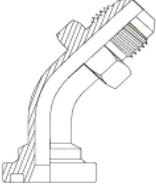
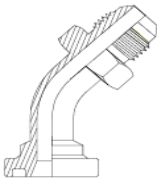
| JIM-F61-45S | JIM-F62-45S |
|--|--|
|  |  |
| JIC Male Code 61 Flange Page 27 | JIC Male Code 62 Flange Page 28 |



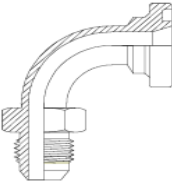
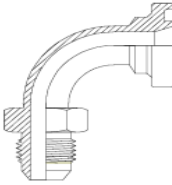



90 Degree

| JIM-F61-90S | JIM-F62-90S |
|---|---|
|  |  |
| JIC Male Code 61 Flange Swept Page 35 | JIC Male Code 62 Flange Swept Page 35 |

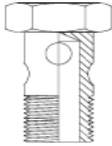
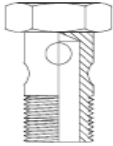

CONTENTS



ANCILLARY ITEMS

Banjo Bolts & Locking Nuts

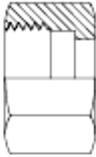
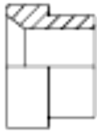



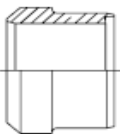

| BBB | | MBB | | BLN | | JLN | | OLN | |
|---|---|---|--|---|---|---|---|-----|--|
|  |  |  |  |  |  |  |  | | |
| BSPP Banjo Bolt Page 128 | Metric Banjo Bolt Page 128 | BSPP Locking Nut Page 128 | JIC Locking Nut Page 128 | ORFS Locking Nut Page 128 | | | | | |

Tube Nut Flares / Compression

| JTN | | JTS | | OTN | |
|--|--|--|--|-----|--|
|  |  |  | | | |
| JIC Tube Nut Page 129 | JIC Tube Sleeve Page 129 | ORFS Tube Nut Page 129 | | | |

| MHN | | MLN | | MCS | |
|---|---|---|--|-----|--|
|  |  |  | | | |
| Metric Heavy Nut Page 77 | Metric Light Nut Page 77 | Metric Compression Olive Page 77 | | | |

O-Rings & Seals

| OR-BSP | | OR-ORF | | OR-SAE | | OR-UNO | | DSB | | DSM | | EDB | |
|---|---|---|---|---|---|---|--|-----|--|-----|--|-----|--|
|  |  |  |  |  |  |  | | | | | | | |
| BSP O-Ring Page 133 | ORFS O-Ring Page 133 | SAE Flange O-Ring Page 133 | UNO O-Ring Page 133 | BSP Dowty Seal Page 133 | Metric Dowty Seal Page 133 | BSP Encapsulated O-Ring Page 133 | | | | | | | |

All Prices Exclude GST

CONTENTS

LOW PRESSURE HOSETAILS

Straight

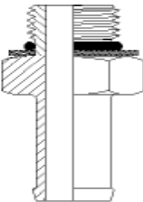
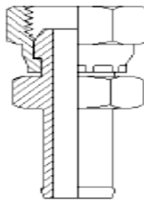
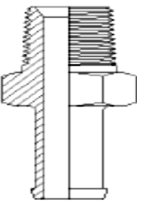
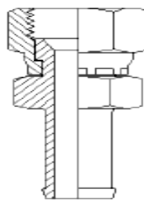
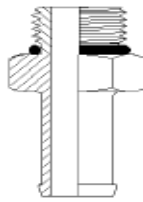
| LPT-BPM | LPT-BSF | LPT-BTM | LPT-JIF | LPT-UNM |
|---|---|---|--|---|
|  |  |  |  |  |
| Suction Tail BSPP Male | Suction Tail BSPP Female | Suction Tail BSPT Male | Suction Tail JIC Female | Suction Tail UNO Male |
| Page 80 | Page 80 | Page 80 | Page 80 | Page 80 |

90 Degree

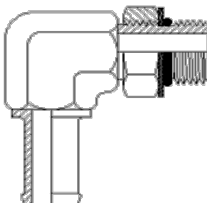
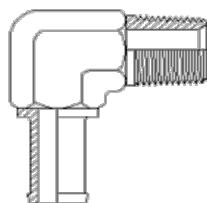
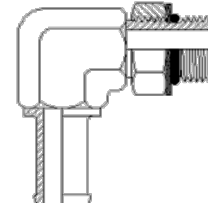
| LPT-BPM-90C | LPT-BTM-90C | LPT-UNM-90C |
|--|--|--|
|  |  |  |
| Suction Tail BSPP Male | Suction Tail BSPT Male | Suction Tail UNO Male |
| Page 81 | Page 81 | Page 81 |

PUSH-LOCK HOSETAILS

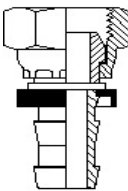
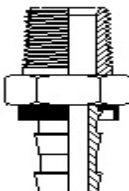
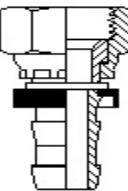
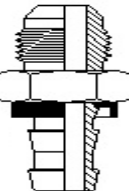
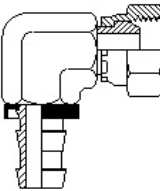
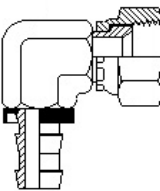
| PO-BSF | PO-BTM | PO-JIF | PO-JIM | PO-BSF-90C | PO-BSF-90C |
|---|---|---|---|---|---|
|  |  |  |  |  |  |
| Push On Tail BSPP Female | Push On Tail BSPT Male | Push On Tail JIC Female | Push On Tail JIC Male | Push On Tail BSPP Female 90° | Push On Tail JIC Female 90° |
| Page 82 | Page 82 | Page 82 | Page 82 | Page 82 | Page 82 |

All Prices Exclude GST

CONTENTS

FIELD ATTACHABLE HOSETAILS

R1AT / R2AT Ferrules

SNR1

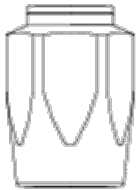

SAE 100R1AT
Ferrule
Page 83

SNR2

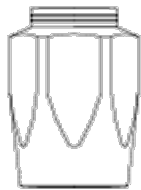

SAE 100R2AT
Ferrule
Page 83

R1AT / R2AT Straight

R-BSF

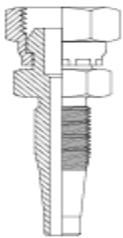

Field
Attachable
BSPP Female
Page 83

R-BTM

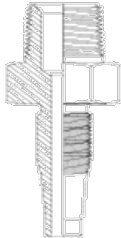

Field
Attachable
BSPT Male
Page 83

R-JIF

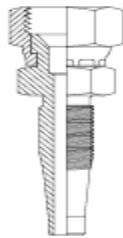

Field
Attachable
JIC Female
Page 83

R-JIM

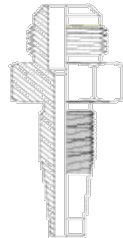

Field
Attachable
JIC Male
Page 83

R-ORF

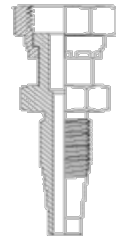

Field
Attachable
ORFS Female
Page 84

R1AT / R2AT 45 Degree

R-BSF-45S

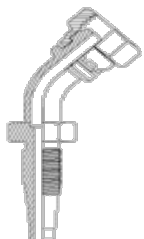

Field
Attachable
BSPP Female
Page 85

R-JIF-45S

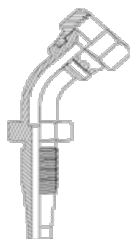

Field
Attachable
JIC Female
Page 85

CONTENTS

R1AT / R2AT 90 Degree

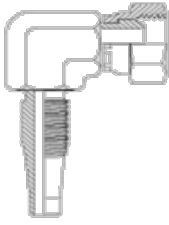
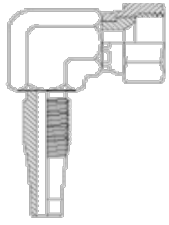
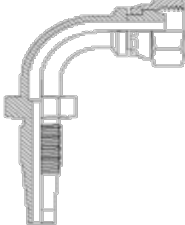
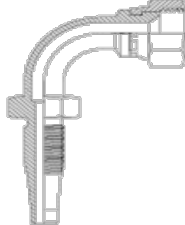
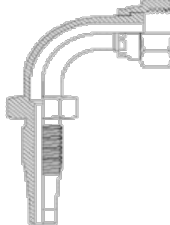
| R-BSF-90C | R-JIF-90C | R-BSF-90S | R-JIF-90S | R-ORF-90S |
|---|---|---|--|---|
|  |  |  |  |  |
| Field Attachable BSPP Female Compact Page 85 | Field Attachable JIC Female Compact Page 85 | Field Attachable BSPP Female Swept Page 86 | Field Attachable JIC Female Swept Page 86 | Field Attachable ORFS Female Swept Page 86 |

R5 HOSETAILS

Straight

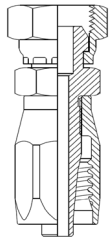
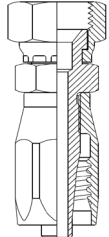
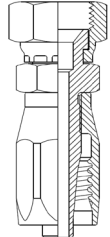
| R5-BSF | R5-JIF | R5-SAF |
|---|---|---|
|  |  |  |
| R5 Tail BSPP Female Page 87 | R5 Tail JIC Female Page 87 | R5 Tail SAE Female Page 87 |

45 Degree

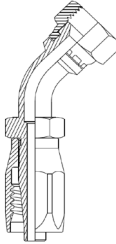
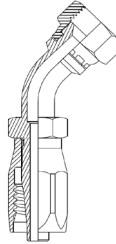
| R5-JIF-45S | R5-SAF-45S |
|---|---|
|  |  |
| R5 Tail JIC Female 45° Page 88 | R5 Tail SAE Female 45° Page 88 |

90 Degree

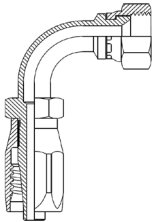
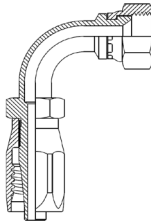
| R5-JIF-90S | R5-SAF-90S |
|---|---|
|  |  |
| R5 Tail JIC Female 90° Page 88 | R5 Tail SAE Female 90° Page 88 |





All Prices Exclude GST





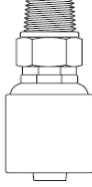

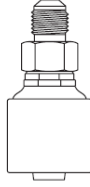
CONTENTS

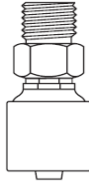



ONE PIECE HOSETAILS

R1AT / R2AT Straight

| STO-BSF | STO-BTM | STO-JIF | STO-JIM | STO-MHF | STO-MHM |
|---|---|---|---|---|---|
|  |  |  |  |  |  |
| One Piece Crimp BSPP Female Page 89 | One Piece Crimp BSPT Male Page 89 | One Piece Crimp JIC Female Page 89 | One Piece Crimp JIC Male Page 90 | One Piece Crimp Metric Heavy Female Page 90 | One Piece Crimp Metric Heavy Male Page 90 |

| STO-MLF | STO-MLM | STO-ORF | STO-ORM | STO-USM |
|--|--|--|--|--|
|  |  |  |  |  |
| One Piece Crimp Metric Light Female Page 91 | One Piece Crimp Metric Light Male Page 91 | One Piece Crimp ORFS Female Page 91 | One Piece Crimp ORFS Male Page 91 | One Piece Crimp UNO Live Swivel Male Page 92 |

R1AT / R2AT 45 Degree

| STO-BSF-45S | STO-JIF-45S | STO-MHF-45S | STO-MLF-45S | STO-ORF-45S |
|---|---|---|--|---|
|  |  |  |  |  |
| One Piece Crimp BSPP Female Page 93 | One Piece Crimp JIC Female Page 93 | One Piece Crimp Metric Heavy Female Page 93 | One Piece Crimp Metric Light Female Page 94 | One Piece Crimp ORFS Female Page 94 |

Gates® products not listed are available upon request.

All Prices Exclude GST

R1AT / R2AT 90 Degree

STO-BSF-90C

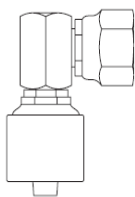

**One Piece
BSPP Female
Compact
Page 95**

STO-BSF-90S

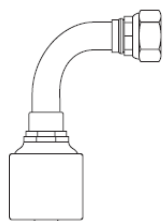

**One Piece
BSPP Female
Swept
Page 96**

STO-JIF-90S



**One Piece
JIC Female
Swept
Page 96**

STO-MHF-90S



**One Piece
Metric Heavy
Female Swept
Page 97**

STO-MLF-90S



**One Piece
Metric Light
Female Swept
Page 97**

STO-ORF-90S

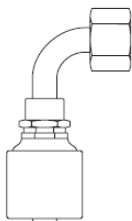

**One Piece
ORFS Female
Swept
Page 98**

STO-USM-90C

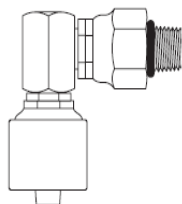





**One Piece Crimp
UNO Live Swivel
Male
Page 95**

Gates® products not listed are available upon request.

All Prices Exclude GST

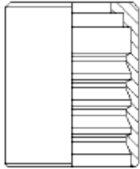
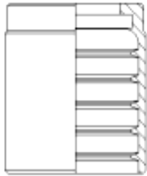
CONTENTS

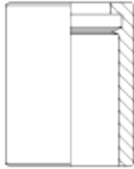
FERRULES

| SN01 | SN02 (N) | SN07 | ST | SNMS | SN4K |
|---|---|---|---|--|---|
|  |  |  |  |  |  |
| SAE 100R1AT Crimp Ferrule Page 111 | SAE 100R1AT / R2AT Dual Purpose Crimp Ferrule Page 111 | SAE 100R7 Crimp Ferrule Page 111 | SAE 100R14 Crimp Ferrule Page 111 | Gates Multi-Spiral Crimp Ferrule (-6 to -16) Page 112 | Gates Multi-Spiral Crimp Ferrule (4K-20) Page 112 |

SN6K



**Gates
Multi-Spiral
Crimp Ferrule
(6K-20)**
Page 112

TWO PIECE HOSETAILS

R1AT / R2AT Straight

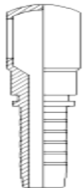
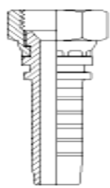
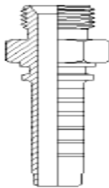
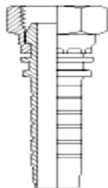
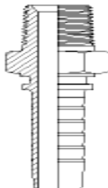
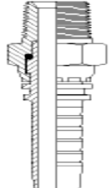
| STB-BBJ | STB-BJF | STB-BPM | STB-BSF | STB-BTM | STB-BSM |
|---|---|---|---|--|---|
|  |  |  |  |  |  |
| Two Piece Crimp BSP Banjo Page 113 | Two Piece Crimp JIS (BSP) Female Page 113 | Two Piece Crimp BSPP Male Page 113 | Two Piece Crimp BSPP Female Page 114 | Two Piece Crimp BSPT Male Page 114 | Two Piece Crimp BSPT Male Swivel Page 114 |

All Prices Exclude GST

CONTENTS

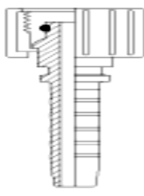
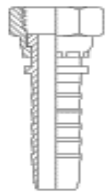
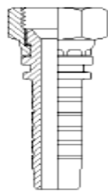
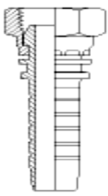
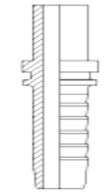
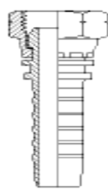
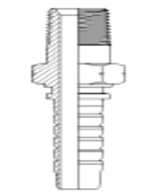
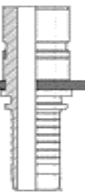
| | | | | | |
|---|---|---|--|---|---|
| STB-F61 | STB-JIF | STB-JIM | STB-KAR | STB-MBJ | STB-MCF |
|  |  |  |  |  |  |
| Two Piece Crimp Code 61 Flange Page 114 | Two Piece Crimp JIC Female Page 115 | Two Piece Crimp JIC Male Page 115 | Two Piece Crimp Metric Waterwash Page 115 | Two Piece Crimp Metric Banjo Page 115 | Two Piece Crimp Chinese Flat Face Page 116 |
| STB-MHF | STB-MHM | STB-MKF | STB-MKM | STB-MLF | STB-MLM |
|  |  |  |  |  |  |
| Two Piece Crimp Metric Heavy Female Page 116 | Two Piece Crimp Metric Heavy Male Page 116 | Two Piece Crimp JIS (Komatsu) Female Page 116 | Two Piece Crimp JIS (Komatsu) Male Page 117 | Two Piece Crimp Metric Light Female Page 117 | Two Piece Crimp Metric Light Male Page 117 |
| STB-MMS | STB-MSP | STB-NSF | STB-NTM | STB-ORF | STB-ORM |
|  |  |  |  |  |  |
| Two Piece Crimp Metric Multi Seal Female Page 118 | Two Piece Crimp Metric Standpipe Page 117 | Two Piece Crimp NPT Female Page 118 | Two Piece Crimp NPT Male Page 118 | Two Piece Crimp ORFS Female Page 118 | Two Piece Crimp ORFS Male Page 118 |
| STB-SAF | STB-SAM | STB-STB | STB-TWF | STB-WEO | |
|  |  |  |  |  | |
| Two Piece Crimp SAE Female Page 119 | Two Piece Crimp SAE Male Page 119 | Two Piece Crimp Hose Joiner Page 119 | Two Piece Crimp Weld On Page 119 | Two Piece Crimp WEO Plug Page 119 | |

All Prices Exclude GST

CONTENTS

R1AT / R2AT 45 Degree

STB-BSF-45S

STB-F61-45S

STB-JIF-45S

STB-MHF-45S

STB-MLF-45S

STB-ORF-45S

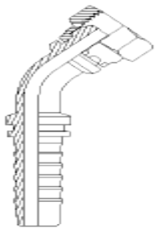

Two Piece
Crimp
BSPP Female
Page 121

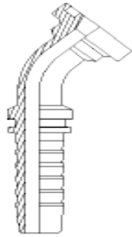

Two Piece
Crimp
Code 61
Flange
Page 121

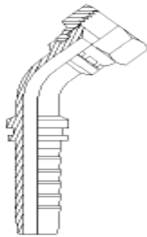

Two Piece
Crimp
JIC Female
Page 121

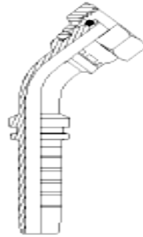

Two Piece
Crimp
Metric Heavy
Female
Page 122

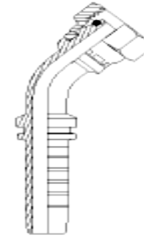

Two Piece
Crimp
Metric Light
Female
Page 122

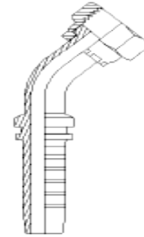

Two Piece
Crimp
ORFS Female
Page 121

R1AT / R2AT 90 Degree Compact

STB-BSF-90C

STB-JIF-90C

STB-USM-90C

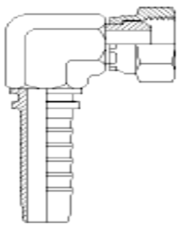

Two Piece Crimp
BSPP Female
Page 123

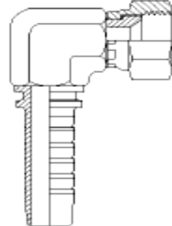

Two Piece Crimp
JIC Female
Page 123

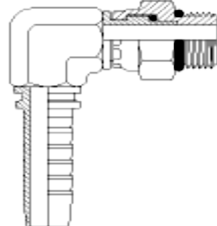

Two Piece Crimp
UNO Male Swivel
Page 123

CONTENTS

R1AT / R2AT 90 Degree Swept

STB-BJF-90S

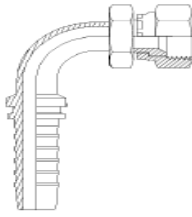

**Two Piece Crimp
JIS (BSP) Female**
Page 124

STB-BSF-90S

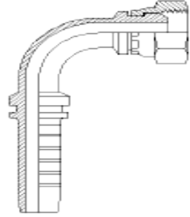

**Two Piece Crimp
BSPP Female**
Page 124

STB-F61-90S

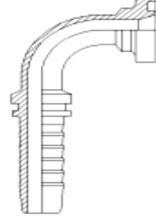

**Two Piece Crimp
Code 61 Flange**
Page 124

STB-JIF-90S

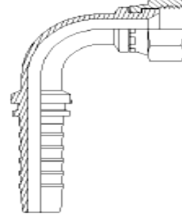

**Two Piece Crimp
JIC Female**
Page 125

STB-MCF-90S

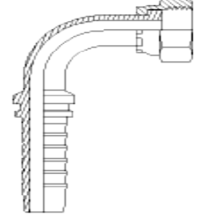

**Two Piece Crimp
Chinese Flat
Face**
Page 125

STB-MHF-90S

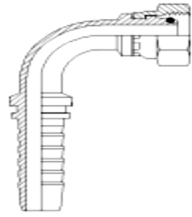

**Two Piece Crimp
Metric Heavy
Female**
Page 125

STB-MKF-90S

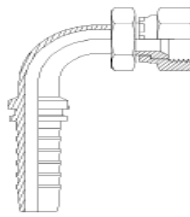

**Two Piece Crimp
JIS (Komatsu)
Female**
Page 126

STB-MLF-90S

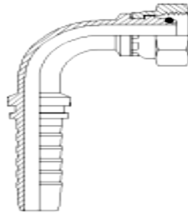

**Two Piece Crimp
Metric Light
Female**
Page 126

STB-MMS-90S

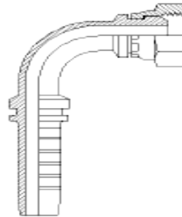

**Two Piece Crimp
Metric Multi Seal
Female**
Page 126

STB-ORF-90S

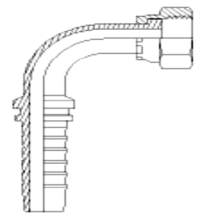

**Two Piece Crimp
ORFS Female**
Page 126

STB-SAF-90S

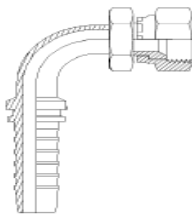

**Two Piece Crimp
SAE Female**
Page 126





All Prices Exclude GST





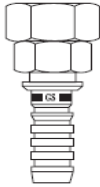

CONTENTS



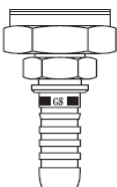

MULTI SPIRAL

Multi-Spiral Straight (-8 to -20)

| STM-BPM | STM-BSF | STM-CAT | STM-F61 | STM-F62 | STM-JIF |
|---|---|---|---|---|---|
|  |  |  |  |  |  |
| Two Piece Crimp BSPP Male | Two Piece Crimp BSPP Female | Two Piece Crimp Caterpillar Flange | Two Piece Crimp Code 61 Flange | Two Piece Crimp Code 62 Flange | Two Piece Crimp JIC Female |
| Page 99 | Page 99 | Page 99 | Page 99 | Page 100 | Page 100 |

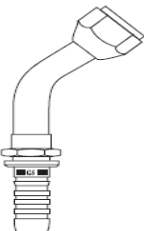
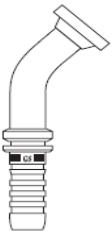
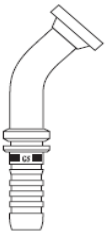
| STM-JIM | STM-MHF | STM-MLF | STM-NTM | STM-ORF |
|--|--|--|--|--|
|  |  |  |  |  |
| Two Piece Crimp JIC Male | Two Piece Crimp Metric Heavy Female | Two Piece Crimp Metric Light Female | Two Piece Crimp NPT Male | Two Piece Crimp ORFS Female |
| Page 101 | Page 101 | Page 102 | Page 102 | Page 102 |

Multi-Spiral 45 Degree (-8 to -20)

| STM-BSF-45S | STM-F61-45S | STM-F62-45S | STM-JIF-45S | STM-MHF-45S | STM-ORF-45S |
|---|---|---|---|--|---|
|  |  |  |  |  |  |
| Two Piece Crimp BSPP Female | Two Piece Crimp Code 61 Flange | Two Piece Crimp Code 62 Flange | Two Piece Crimp JIC Female | Two Piece Crimp Metric Heavy Female | Two Piece Crimp ORFS Female |
| Page 103 | Page 103 | Page 104 | Page 104 | Page 105 | Page 105 |

Gates® products not listed are available upon request.

All Prices Exclude GST

CONTENTS

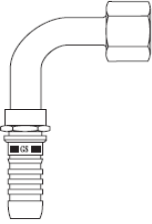
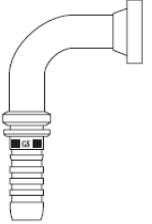
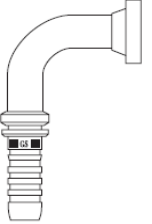
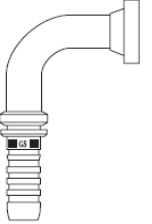
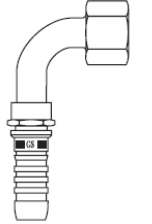
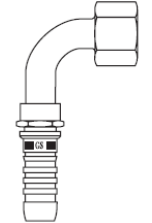
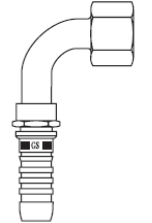
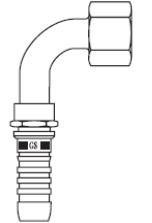

Multi-Spiral 90 Degree (-8 to -20)

| STM-BSF-90S | STM-CAT-90S | STM-F61-90S | STM-F62-90S | STM-JIF-90S |
|--|--|--|---|---|
|  |  |  |  |  |
| Two Piece Crimp BSPF Female Page 107 | Two Piece Crimp Caterpillar Flange Page 107 | Two Piece Crimp Code 61 Flange Page 107 | Two Piece Crimp Code 62 Flange Page 108 | Two Piece Crimp JIC Female Page 108 |
| STM-MHF-90S | STM-MLF-90S | STM-ORF-90S | | |
|  |  |  | | |
| Two Piece Crimp Metric Heavy Female Page 109 | Two Piece Crimp Metric Light Female Page 109 | Two Piece Crimp ORFS Female Page 110 | | |



Gates® products not listed are available upon request.



All Prices Exclude GST

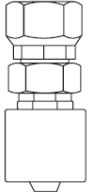

CONTENTS

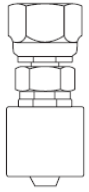
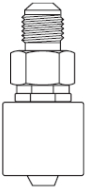
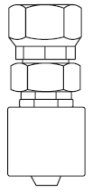
Multi-Spiral Straight (-24 & -32)

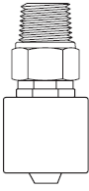
| STMO-BSF | STMO-F61 | STMO-F62 | STMO-JIF | STMO-JIM | STMO-MHF |
|---|---|---|---|---|---|
|  |  |  |  |  |  |
| One Piece Crimp BSPP Female Page 99 | One Piece Crimp Code 61 Flange Page 99 | One Piece Crimp Code 62 Flange Page 100 | One Piece Crimp JIC Female Page 100 | One Piece Crimp JIC Male Page 101 | One Piece Crimp Metric Heavy Female Page 101 |

| STMO-NTM | STMO-ORF |
|--|--|
|  |  |
| One Piece Crimp NPT Male Page 102 | One Piece Crimp ORFS Female Page 102 |

Multi-Spiral 45 Degree (-24 & -32)

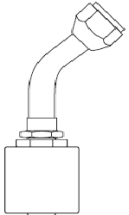
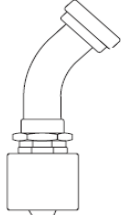
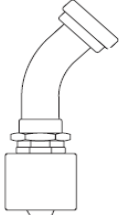
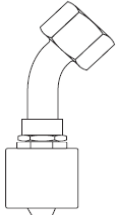
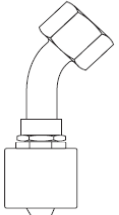
| STMO-BSF-45S | STMO-F61-45S | STMO-F62-45S | STMO-JIF-45S | STMO-MHF-45S |
|---|---|---|--|---|
|  |  |  |  |  |
| One Piece Crimp BSPP Female Page 103 | One Piece Crimp Code 61 Flange Page 103 | One Piece Crimp Code 62 Flange Page 104 | One Piece Crimp JIC Female Page 104 | One Piece Crimp Metric Heavy Female Page 105 |

Gates® products not listed are available upon request.

All Prices Exclude GST

CONTENTS



STMO-ORF-45S

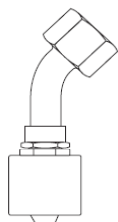

**One Piece
ORFS Female
Swept
Page 105**

Multi-Spiral 90 Degree (-24 & -32)

STMO-BSF-90S

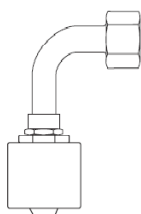

**One Piece
BSPF Female
Swept
Page 107**

STMO-F61-90S

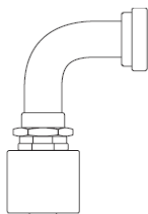

**One Piece
Code 61 Flange
Swept
Page 107**

STMO-F62-90S

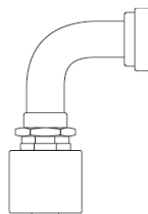

**One Piece
Code 62 Flange
Swept
Page 108**

STMO-JIF-90S

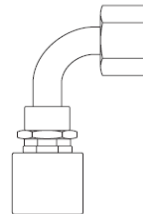

**One Piece
JIC Female
Swept
Page 108**

STMO-MHF-90S

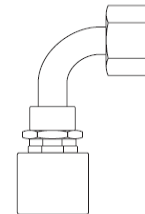

**One Piece
Metric Heavy
Female Swept
Page 109**

STMO-ORF-90S

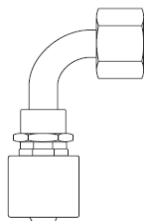



**One Piece
ORFS Female
Swept
Page 110**

Gates® products not listed are available upon request.

All Prices Exclude GST

CONTENTS

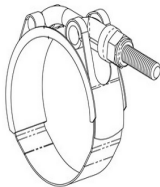
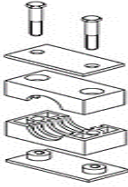
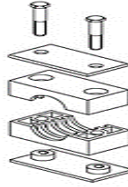



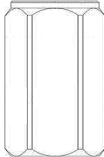
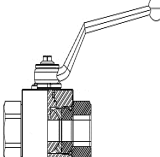
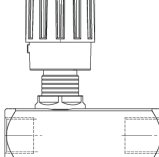
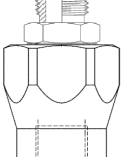
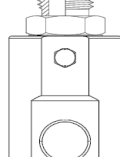
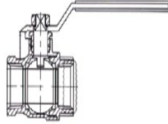

ASSOCIATED ITEMS

| HO | SC | RTCS | RTCS HD | RTCT | HT |
|---|---|---|---|--|---|
|  |  |  |  |  |  |
| ISO Grade 46 & 68 Hydraulic Oil | T-Bolt Super Clamps | Single Tube Clamps | Single Tube Clamps Heavy Duty | Double Tube Clamps | Hydraulic Tube Imperial & Metric |
| Page 128 | Page 129 | Page 131 | Page 131 | Page 132 | Page 132 |

Valves

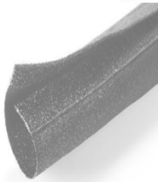
| CV | BV | FCV | GGIL | GG90 | LPBV |
|--|--|--|--|---|---|
|  |  |  |  |  |  |
| Inline Check Valve | High Pressure Ball Valve | Flow Control Valve Reverse Check | Rotating Coupling Straight (Live Swivel) | Rotating Coupling 90° (Live Swivel) | Low Pressure Ball Valve |
| Page 134 | Page 134 | Page 134 | Page 134 | Page 134 | Page 134 |

Hose Protection

| AAS | FPS | FS | R**SSG | RCPP | SG | SP |
|---|---|---|---|--|---|---|
|  |  |  |  |  |  |  |
| Anti- Abrasion Burst Sleeve | Fire Proof Sleeve | Waterproof Velcro Fast Sleeve | Plastic Spiral Guard | PVC P-Clamp | Spring Guard | Service Plug Kits |
| Page 135 | Page 136 | Page 136 | Page 135 | Page 136 | Page 135 | Page 136 |

All Prices Exclude GST

CONTENTS

STAINLESS STEEL FITTINGS

Adaptors

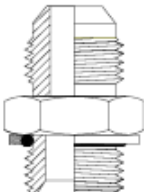
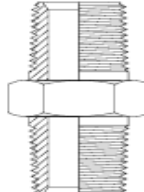
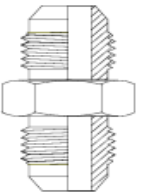
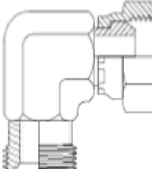
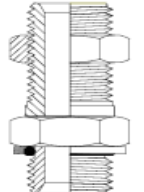
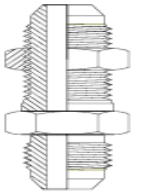
| S-BPM-JIM | S-BTM-BTM | S-JIM-JIM | S-BPM-BSF-90C | S-BPM-BBM | S-JIM-JBM |
|---|---|---|---|---|---|
|  |  |  |  |  |  |
| BSPP Male JIC Male Stainless | BSPT Male BSPT Male Stainless | JIC Male JIC Male Stainless | BSPP Male BSPP Female Swivel 90° Stainless | BSPP Male BSPP Male Bulkhead Stainless | JIC Male JIC Male Bulkhead Stainless |
| Page 138 | Page 138 | Page 138 | Page 138 | Page 139 | Page 139 |

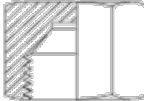
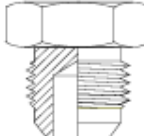
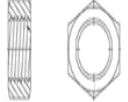
| S-JIF | S-JIM | S-BLN |
|---|--|--|
|  |  |  |
| JIC Cap Stainless | JIC Plug Stainless | BSPP Locking Nut Stainless |
| Page 139 | Page 139 | Page 139 |

Two Piece Hosetails

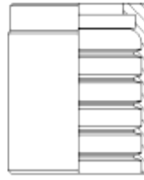
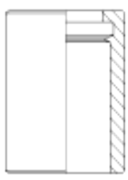
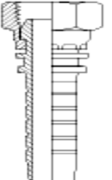
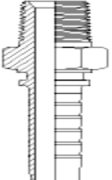
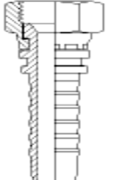
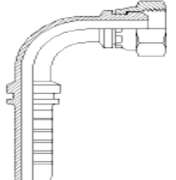







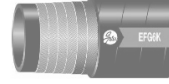

| S-SN02 (N) | S-ST | S-STB-BSF | S-STB-BTM | S-STB-JIF | S-STB-BSF-90S |
|---|---|---|---|---|---|
|  |  |  |  |  |  |
| SAE 100R1AT / R2AT Dual Purpose Crimp Ferrule Stainless | SAE 100R14 Crimp Ferrule Stainless | Two Piece Crimp BSPP Female Stainless | Two Piece Crimp BSPT Male Stainless | Two Piece Crimp JIC Female Stainless | Two Piece Crimp BSPP Female 90° Stainless |
| Page 140 | Page 111 | Page 140 | Page 140 | Page 140 | Page 140 |

All Prices Exclude GST

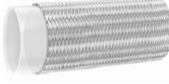

CONTENTS







HYDRAULIC HOSE

| R1AT | R2AT | 4K | 6K | R4 | R5 |
|---|---|---|---|--|---|
|  |  |  |  |  |  |
| Gates SAE 100R1AT Single Braid Hose Page 142 | Gates SAE 100R2AT Double Braid Hose Page 143 | Gates Multi-Spiral 4,000 PSI Hose Page 144 | Gates Multi-Spiral 6,000 PSI Hose Page 144 | SAE 100R4 Suction Delivery Hose Page 145 | SAE 100R5 High Temp Textile/Steel Braid Hose Page 145 |
| R6 | LOLA | R14 | RMP | R2PW | R17 |
|  |  |  |  |  |  |
| SAE 100R6 Low Pressure Push On Hose Page 146 | Gates LOLA Push Lock Hose Page 146 | SAE 100R14 Stainless Steel Teflon Hose Page 147 | Multi-Purpose Red Hose Page 147 | Pressure Wash Double Braid Non-Marking Hose Page 148 | Gates SAE 100R17 Single / Double Braid Hose Page 148 |

Gates® products not listed are available upon request.

GAUGES & TEST HOSES



Gauges

| PG63B | PG63B D | PG100B | PGK-2 | PGK-1D | PGK-3 |
|---|---|---|---|--|---|
|  |  |  |  |  |  |
| 63mm Pressure Gauge Bottom Entry Page 150 | 63mm Pressure Gauge Bottom Entry Digital Page 150 | 100mm Pressure Gauge Bottom Entry Page 150 | Pressure Gauge Kit C/W Assorted Fittings Page 151 | Pressure Gauge Kit C/W Assorted Fittings Digital Page 151 | Pressure Gauge Test Kit Page 151 |

All Prices Exclude GST

CONTENTS

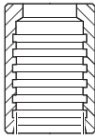
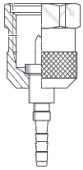
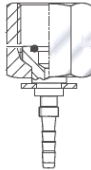
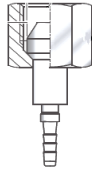
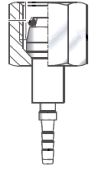
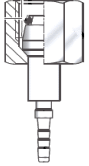
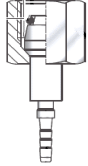
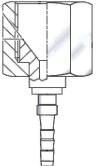
Test Hose & Hosetails

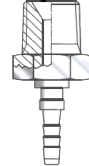
| T2H | TSF | TST-T20 | TST-BGF | TST-BSF | TST-MLF |
|--|--|--|--|--|---|
|  |  |  |  |  |  |
| Test Hose 630 BAR Page 152 | Test Hose Crimp Ferrule Page 152 | Two Piece Crimp Test 20 Coupling Page 152 | Two Piece Crimp Gauge Female Page 152 | Two Piece Crimp BSPP Female Page 152 | Two Piece Crimp Metric Light Female Page 153 |
| TST-MLLF | TST-MHF | TST-JIF | TST-BPM | TST-BTM | |
|  |  |  |  |  | |
| Two Piece Crimp Metric Extra Light Female Page 153 | Two Piece Crimp Metric Heavy Female Page 153 | Two Piece Crimp JIC Female Page 153 | Two Piece Crimp BSPP Male Cone Seated Page 153 | Two Piece Crimp BSPT Male Page 153 | |

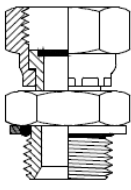
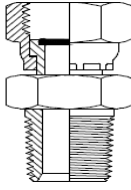
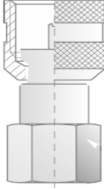
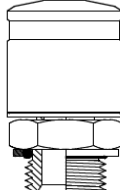
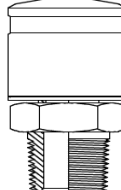
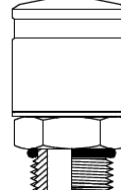

Test / Gauge Adaptors

| BGF-BPM | BGF-BTM | BGF-TEST | BPM-TEST | BTM-TEST | UNM-TEST |
|---|---|---|---|---|---|
|  |  |  |  |  |  |
| BSPP Male Gauge Female Swivel Page 154 | BSPT Male Gauge Female Swivel Page 154 | Gauge Female Test 20 Female Page 154 | BSPP Male Test 20 Male Page 154 | BSPT Male Test 20 Male Page 154 | UNO Male Test 20 Male Page 154 |

All Prices Exclude GST

CONTENTS

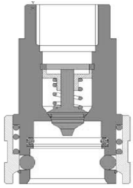
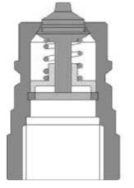
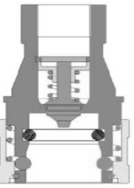
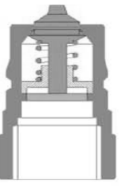
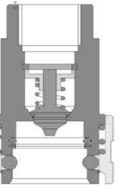
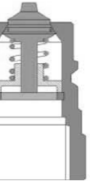
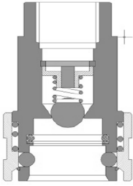
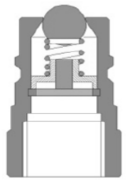
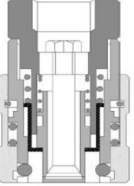
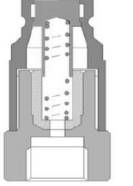
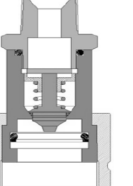
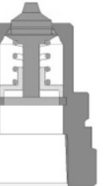
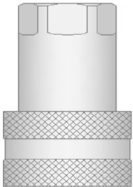
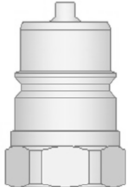
QUICK RELEASE COUPLINGS

| | | | | | |
|---|---|---|---|--|--|
| RQRA-F | RQRA-M | RQRB-F | RQRB-M | RQRV-F | RQRV-M |
|  |  |  |  |  |  |
| ISO 7241-1 A Poppet Series Female | ISO 7241-1 A Poppet Series Male | ISO 7241-1 B Poppet Series Female | ISO 7241-1 B Poppet Series Male | ISO 7241-1 NV Poppet Series Female | ISO 7241-1 NV Poppet Series Male |
| Page 157 | Page 157 | Page 158 | Page 158 | Page 159 | Page 159 |
| RQRS-F | RQRS-M | RQFF-F | RQFF-M | RQRJ-F | RQRJ-M |
|  |  |  |  |  |  |
| ISO 7241-1 Ball Series Female | ISO 7241-1 Ball Series Male | ISO 16028 Flat Face Female | ISO 16028 Flat Face Male | 700 BAR Jacking Screw Together Female | 700 BAR Jacking Screw Together Male |
| Page 160 | Page 160 | Page 161 | Page 161 | Page 162 | Page 162 |
| RQPBR-F | RQPBR-M | RQRT-F | RQRT-M | | |
|  |  |  |  | | |
| PBR Truck Interchange Female | PBR Truck Interchange Male | TEMA Interchange Female | TEMA Interchange Male | | |
| Page 162 | Page 162 | Page 163 | Page 163 | | |

All Prices Exclude GST

CONTENTS

All Prices Exclude GST

A technical drawing of a mechanical assembly, possibly a camera lens or a similar optical device, rendered in light blue lines on a dark blue background. The drawing shows a complex assembly of cylindrical and rectangular components, with some parts indicated by dashed lines to show hidden internal features. The word "ADAPTORS" is overlaid in large, bold, white capital letters across the center of the image.

ADAPTORS

Straight Adaptors

BSPP Male x BSPP Female Reducer/Expander

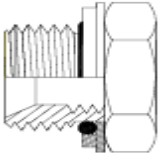

| | |
|--------------|---------------------------|
| BPM-BPF-0204 | 1/8 BSPPM x 1/4 BSPPF |
| BPM-BPF-0402 | 1/4 BSPPM x 1/8 BSPPF |
| BPM-BPF-0404 | 1/4 BSPPM X 1/4 BSPPF |
| BPM-BPF-0406 | 1/4 BSPPM x 3/8 BSPPF |
| BPM-BPF-0602 | 3/8 BSPPM x 1/8 BSPPF |
| BPM-BPF-0604 | 3/8 BSPPM x 1/4 BSPPF |
| BPM-BPF-0606 | 3/8 BSPPM x 3/8 BSPPF |
| BPM-BPF-0608 | 3/8 BSPPM x 1/2 BSPPF |
| BPM-BPF-0804 | 1/2 BSPPM x 1/4 BSPPF |
| BPM-BPF-0806 | 1/2 BSPPM x 3/8 BSPPF |
| BPM-BPF-0808 | 1/2 BSPPM x 1/2 BSPPF |
| BPM-BPF-0812 | 1/2 BSPPM x 3/4 BSPPF |
| BPM-BPF-1204 | 3/4 BSPPM x 1/4 BSPPF |
| BPM-BPF-1206 | 3/4 BSPPM x 3/8 BSPPF |
| BPM-BPF-1208 | 3/4 BSPPM x 1/2 BSPPF |
| BPM-BPF-1212 | 3/4 BSPPM x 3/4 BSPPF |
| BPM-BPF-1216 | 3/4 BSPPM x 1 BSPPF |
| BPM-BPF-1606 | 1 BSPPM x 3/8 BSPPF |
| BPM-BPF-1608 | 1 BSPPM x 1/2 BSPPF |
| BPM-BPF-1612 | 1 BSPPM x 3/4 BSPPF |
| BPM-BPF-1616 | 1 BSPPM x 1 BSPPF |
| BPM-BPF-1620 | 1 BSPPM X 1-1/4 BSPPF |
| BPM-BPF-2008 | 1-1/4 BSPPM x 1/2 BSPPF |
| BPM-BPF-2012 | 1-1/4 BSPPM x 3/4 BSPPF |
| BPM-BPF-2016 | 1-1/4 BSPPM x 1 BSPPF |
| BPM-BPF-2020 | 1-1/4 BSPPM X 1-1/4 BSPPF |
| BPM-BPF-2416 | 1-1/2 BSPPM x 1 BSPPF |
| BPM-BPF-2420 | 1-1/2 BSPPM x 1-1/4 BSPPF |
| BPM-BPF-3224 | 2 BSPPM x 1-1/2 BSPPF |

BSPP Male x BSPP Male Nipple

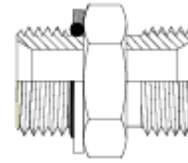

| | |
|--------------|---------------------------|
| BPM-BPM-0202 | 1/8 BSPPM x 1/8 BSPPM |
| BPM-BPM-0204 | 1/8 BSPPM x 1/4 BSPPM |
| BPM-BPM-0404 | 1/4 BSPPM x 1/4 BSPPM |
| BPM-BPM-0406 | 1/4 BSPPM x 3/8 BSPPM |
| BPM-BPM-0408 | 1/4 BSPPM x 1/2 BSPPM |
| BPM-BPM-0606 | 3/8 BSPPM x 3/8 BSPPM |
| BPM-BPM-0608 | 3/8 BSPPM x 1/2 BSPPM |
| BPM-BPM-0612 | 3/8 BSPPM x 3/4 BSPPM |
| BPM-BPM-0808 | 1/2 BSPPM x 1/2 BSPPM |
| BPM-BPM-0810 | 1/2 BSPPM x 5/8 BSPPM |
| BPM-BPM-0812 | 1/2 BSPPM x 3/4 BSPPM |
| BPM-BPM-0816 | 1/2 BSPPM x 1 BSPPM |
| BPM-BPM-1010 | 5/8 BSPPM x 5/8 BSPPM |
| BPM-BPM-1212 | 3/4 BSPPM x 3/4 BSPPM |
| BPM-BPM-1216 | 3/4 BSPPM x 1 BSPPM |
| BPM-BPM-1220 | 3/4 BSPPM x 1-1/4 BSPPM |
| BPM-BPM-1616 | 1 BSPPM x 1 BSPPM |
| BPM-BPM-1620 | 1 BSPPM x 1-1/4 BSPPM |
| BPM-BPM-1624 | 1 BSPPM X 1-1/2 BSPPM |
| BPM-BPM-2020 | 1-1/4 BSPPM x 1-1/4 BSPPM |
| BPM-BPM-2024 | 1-1/4 BSPPM x 1-1/2 BSPPM |
| BPM-BPM-2424 | 1-1/2 BSPPM x 1-1/2 BSPPM |
| BPM-BPM-2432 | 1-1/2 BSPPM x 2 BSPPM |
| BPM-BPM-3232 | 2 BSPPM x 2 BSPPM |

BSP Banjo x JIC Male

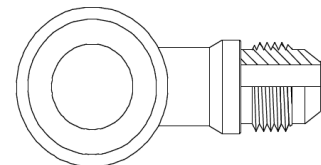

| | |
|--------------|---------------------------|
| BBJ-JIM-0407 | 1/4 BSP Banjo x 7/16 JICM |
| BBJ-JIM-0409 | 1/4 BSP Banjo x 9/16 JICM |
| BBJ-JIM-0609 | 3/8 BSP Banjo x 9/16 JICM |
| BBJ-JIM-0812 | 1/2 BSP Banjo x 3/4 JICM |

BSPB Socket

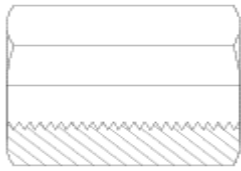

| | |
|--------------|-------------------|
| BPF-BPF-0202 | 1/8 BSPB Socket |
| BPF-BPF-0404 | 1/4 BSPB Socket |
| BPF-BPF-0606 | 3/8 BSPB Socket |
| BPF-BPF-0808 | 1/2 BSPB Socket |
| BPF-BPF-1212 | 3/4 BSPB Socket |
| BPF-BPF-1616 | 1 BSPB Socket |
| BPF-BPF-2020 | 1-1/4 BSPB Socket |
| BPF-BPF-2424 | 1-1/2 BSPB Socket |

BSPB Male x BSPB Female Swivel

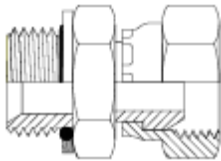

| | |
|--------------|---------------------------|
| BPM-BSF-0204 | 1/8 BSPPM x 1/4 BSPPF |
| BPM-BSF-0404 | 1/4 BSPPM x 1/4 BSPPF |
| BPM-BSF-0406 | 1/4 BSPPM x 3/8 BSPPF |
| BPM-BSF-0604 | 3/8 BSPPM x 1/4 BSPPF |
| BPM-BSF-0606 | 3/8 BSPPM x 3/8 BSPPF |
| BPM-BSF-0608 | 3/8 BSPPM x 1/2 BSPPF |
| BPM-BSF-0806 | 1/2 BSPPM x 3/8 BSPPF |
| BPM-BSF-0808 | 1/2 BSPPM x 1/2 BSPPF |
| BPM-BSF-0812 | 1/2 BSPPM x 3/4 BSPPF |
| BPM-BSF-1212 | 3/4 BSPPM x 3/4 BSPPF |
| BPM-BSF-1216 | 3/4 BSPPM x 1 BSPPF |
| BPM-BSF-1612 | 1 BSPPM x 3/4 BSPPF |
| BPM-BSF-1616 | 1 BSPPM x 1 BSPPF |
| BPM-BSF-1620 | 1 BSPPM x 1-1/4 BSPPF |
| BPM-BSF-2016 | 1-1/4 BSPPM x 1 BSPPF |
| BPM-BSF-2020 | 1-1/4 BSPPM x 1-1/4 BSPPF |
| BPM-BSF-2424 | 1-1/2 BSPPM x 1-1/2 BSPPF |
| BPM-BSF-3232 | 2 BSPPM x 2 BSPPF |

BSPB Male x BSPT Male Nipple

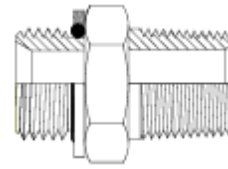

| | |
|--------------|---------------------------|
| BPM-BTM-0202 | 1/8 BSPPM x 1/8 BSPTM |
| BPM-BTM-0204 | 1/8 BSPPM x 1/4 BSPTM |
| BPM-BTM-0402 | 1/4 BSPPM x 1/8 BSPTM |
| BPM-BTM-0404 | 1/4 BSPPM x 1/4 BSPTM |
| BPM-BTM-0406 | 1/4 BSPPM x 3/8 BSPTM |
| BPM-BTM-0408 | 1/4 BSPPM x 1/2 BSPTM |
| BPM-BTM-0604 | 3/8 BSPPM x 1/4 BSPTM |
| BPM-BTM-0606 | 3/8 BSPPM x 3/8 BSPTM |
| BPM-BTM-0608 | 3/8 BSPPM x 1/2 BSPTM |
| BPM-BTM-0612 | 3/8 BSPPM x 3/4 BSPTM |
| BPM-BTM-0804 | 1/2 BSPPM x 1/4 BSPTM |
| BPM-BTM-0806 | 1/2 BSPPM x 3/8 BSPTM |
| BPM-BTM-0808 | 1/2 BSPPM x 1/2 BSPTM |
| BPM-BTM-0812 | 1/2 BSPPM x 3/4 BSPTM |
| BPM-BTM-0816 | 1/2 BSPPM x 1 BSPTM |
| BPM-BTM-1206 | 3/4 BSPPM x 3/8 BSPTM |
| BPM-BTM-1208 | 3/4 BSPPM x 1/2 BSPTM |
| BPM-BTM-1212 | 3/4 BSPPM x 3/4 BSPTM |
| BPM-BTM-1216 | 3/4 BSPPM x 1 BSPTM |
| BPM-BTM-1220 | 3/4 BSPPM x 1-1/4 BSPTM |
| BPM-BTM-1608 | 1 BSPPM x 1/2 BSPTM |
| BPM-BTM-1612 | 1 BSPPM x 3/4 BSPTM |
| BPM-BTM-1616 | 1 BSPPM x 1 BSPTM |
| BPM-BTM-1620 | 1 BSPPM x 1-1/4 BSPTM |
| BPM-BTM-2016 | 1-1/4 BSPPM x 1 BSPTM |
| BPM-BTM-2020 | 1-1/4 BSPPM x 1-1/4 BSPTM |
| BPM-BTM-2024 | 1-1/4 BSPPM x 1-1/2 BSPTM |
| BPM-BTM-2416 | 1-1/2 BSPPM x 1 BSPTM |
| BPM-BTM-2420 | 1-1/2 BSPPM x 1-1/4 BSPTM |
| BPM-BTM-2424 | 1-1/2 BSPPM x 1-1/2 BSPTM |
| BPM-BTM-3232 | 2 BSPPM x 2 BSPTM |

BSPP Male x JIC Female Swivel

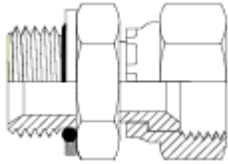

| | |
|--------------|----------------------------|
| BPM-JIF-0407 | 1/4 BSPPM x 7/16 JICFS |
| BPM-JIF-0409 | 1/4 BSPPM x 9/16 JICFS |
| BPM-JIF-0412 | 1/4 BSPPM x 3/4 JICFS |
| BPM-JIF-0607 | 3/8 BSPPM x 7/16 JICFS |
| BPM-JIF-0609 | 3/8 BSPPM x 9/16 JICFS |
| BPM-JIF-0612 | 3/8 BSPPM x 3/4 JICFS |
| BPM-JIF-0614 | 3/8 BSPPM x 7/8 JICFS |
| BPM-JIF-0809 | 1/2 BSPPM x 9/16 JICFS |
| BPM-JIF-0812 | 1/2 BSPPM x 3/4 JICFS |
| BPM-JIF-0814 | 1/2 BSPPM x 7/8 JICFS |
| BPM-JIF-0817 | 1/2 BSPPM x 1-1/16 JICFS |
| BPM-JIF-1214 | 3/4 BSPPM x 7/8 JICFS |
| BPM-JIF-1217 | 3/4 BSPPM x 1-1/16 JICFS |
| BPM-JIF-1221 | 3/4 BSPPM x 1-5/16 JICFS |
| BPM-JIF-1617 | 1 BSPPM x 1-1/16 JICFS |
| BPM-JIF-1621 | 1 BSPPM x 1-5/16 JICFS |
| BPM-JIF-2021 | 1-1/4 BSPPM x 1-5/16 JICFS |
| BPM-JIF-2026 | 1-1/4 BSPPM x 1-5/8 JICFS |
| BPM-JIF-2430 | 1-1/2 BSPPM x 1-7/8 JICFS |

BSPP Male x JIC Male Nipple

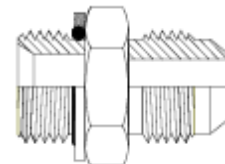

| | |
|--------------|---------------------------|
| BPM-JIM-0207 | 1/8 BSPPM x 7/16 JICM |
| BPM-JIM-0208 | 1/8 BSPPM x 1/2 JICM |
| BPM-JIM-0209 | 1/8 BSPPM x 9/16 JICM |
| BPM-JIM-0407 | 1/4 BSPPM x 7/16 JICM |
| BPM-JIM-0408 | 1/4 BSPPM x 1/2 JICM |
| BPM-JIM-0409 | 1/4 BSPPM x 9/16 JICM |
| BPM-JIM-0412 | 1/4 BSPPM x 3/4 JICM |
| BPM-JIM-0607 | 3/8 BSPPM x 7/16 JICM |
| BPM-JIM-0608 | 3/8 BSPPM x 1/2 JICM |
| BPM-JIM-0609 | 3/8 BSPPM x 9/16 JICM |
| BPM-JIM-0612 | 3/8 BSPPM x 3/4 JICM |
| BPM-JIM-0614 | 3/8 BSPPM x 7/8 JICM |
| BPM-JIM-0617 | 3/8 BSPPM x 1-1/16 JICM |
| BPM-JIM-0807 | 1/2 BSPPM x 7/16 JICM |
| BPM-JIM-0809 | 1/2 BSPPM x 9/16 JICM |
| BPM-JIM-0812 | 1/2 BSPPM x 3/4 JICM |
| BPM-JIM-0814 | 1/2 BSPPM x 7/8 JICM |
| BPM-JIM-0817 | 1/2 BSPPM x 1-1/16 JICM |
| BPM-JIM-0821 | 1/2 BSPPM x 1-5/16 JICM |
| BPM-JIM-1209 | 3/4 BSPPM x 9/16 JICM |
| BPM-JIM-1212 | 3/4 BSPPM x 3/4 JICM |
| BPM-JIM-1214 | 3/4 BSPPM x 7/8 JICM |
| BPM-JIM-1217 | 3/4 BSPPM x 1-1/16 JICM |
| BPM-JIM-1219 | 3/4 BSPPM x 1-3/16 JICM |
| BPM-JIM-1221 | 3/4 BSPPM x 1-5/16 JICM |
| BPM-JIM-1612 | 1 BSPPM x 3/4 JICM |
| BPM-JIM-1614 | 1 BSPPM x 7/8 JICM |
| BPM-JIM-1617 | 1 BSPPM x 1-1/16 JICM |
| BPM-JIM-1619 | 1 BSPPM x 1-3/16 JICM |
| BPM-JIM-1621 | 1 BSPPM x 1-5/16 JICM |
| BPM-JIM-1626 | 1 BSPPM x 1-5/8 JICM |
| BPM-JIM-2017 | 1-1/4 BSPPM x 1-1/16 JICM |
| BPM-JIM-2021 | 1-1/4 BSPPM x 1-5/16 JICM |
| BPM-JIM-2026 | 1-1/4 BSPPM x 1-5/8 JICM |
| BPM-JIM-2030 | 1 1/4 BSPPM x 1 7/8 JICM |
| BPM-JIM-2421 | 1-1/2 BSPPM x 1-5/16 JICM |
| BPM-JIM-2426 | 1-1/2 BSPPM x 1-5/8 JICM |
| BPM-JIM-2430 | 1-1/2 BSPPM x 1-7/8 JICM |
| BPM-JIM-3230 | 2 BSPPM x 1-7/8 JICM |
| BPM-JIM-3240 | 2 BSPPM x 2-1/2 JICM |

BSPP Male x Metric Stud Male Nipple

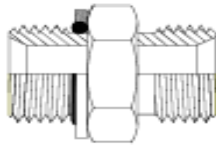

| | |
|--------------|---------------------|
| BPM-MSM-0414 | 1/4 BSPPM x M14X1.5 |
| BPM-MSM-0416 | 1/4 BSPPM x M16X1.5 |
| BPM-MSM-0418 | 1/4 BSPPM x M18X1.5 |
| BPM-MSM-0614 | 3/8 BSPPM x M14X1.5 |
| BPM-MSM-0616 | 3/8 BSPPM x M16X1.5 |
| BPM-MSM-0618 | 3/8 BSPPM x M18X1.5 |
| BPM-MSM-0818 | 1/2 BSPPM x M18X1.5 |
| BPM-MSM-1222 | 3/4 BSPPM x M22X1.5 |
| BPM-MSM-1230 | 3/4 BSPPM x M30X1.5 |

BSPP Male x NPT Male Nipple

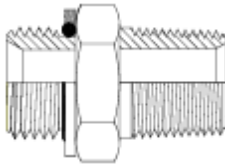

| | |
|--------------|-------------------------|
| BPM-NTM-0404 | 1/4 BSPP x 1/4 NPTM |
| BPM-NTM-0606 | 3/8 BSPP x 3/8 NPTM |
| BPM-NTM-0808 | 1/2 BSPP x 1/2 NPTM |
| BPM-NTM-1212 | 3/4 BSPP x 3/4 NPTM |
| BPM-NTM-1616 | 1 BSPP x 1 NPTM |
| BPM-NTM-2020 | 1-1/4 BSPP x 1-1/4 NPTM |
| BPM-NTM-2424 | 1-1/2 BSPP x 1-1/2 NPTM |
| BPM-NTM-3232 | 2 BSPP x 2 NPTM |

BSPP Male x ORFS Female Swivel

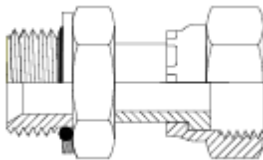

| | |
|--------------|-------------------------|
| BPM-ORF-0409 | 1/4 BSPP x 9/16 ORFSF |
| BPM-ORF-0411 | 1/4 BSPP x 11/16 ORFSF |
| BPM-ORF-0611 | 3/8 BSPP x 11/16 ORFSF |
| BPM-ORF-0613 | 3/8 BSPP x 13/16 ORFSF |
| BPM-ORF-0813 | 1/2 BSPP x 13/16 ORFSF |
| BPM-ORF-0816 | 1/2 BSPP x 1 ORFSF |
| BPM-ORF-1219 | 3/4 BSPP x 1-3/16 ORFSF |
| BPM-ORF-1623 | 1 BSPP x 1-7/16 ORFSF |

BSPP Male x ORFS Male Nipple

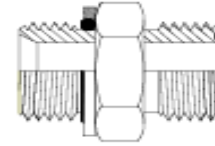

| | |
|--------------|-----------------------------|
| BPM-ORM-0209 | 1/8 BSPPM x 9/16 ORFSM |
| BPM-ORM-0409 | 1/4 BSPPM x 9/16 ORFSM |
| BPM-ORM-0411 | 1/4 BSPPM x 11/16 ORFSM |
| BPM-ORM-0413 | 1/4 BSPPM x 13/16 ORFSM |
| BPM-ORM-0609 | 3/8 BSPPM x 9/16 ORFSM |
| BPM-ORM-0611 | 3/8 BSPPM x 11/16 ORFSM |
| BPM-ORM-0613 | 3/8 BSPPM x 13/16 ORFSM |
| BPM-ORM-0809 | 1/2 BSPPM x 9/16 ORFSM |
| BPM-ORM-0811 | 1/2 BSPPM x 11/16 ORFSM |
| BPM-ORM-0813 | 1/2 BSPPM x 13/16 ORFSM |
| BPM-ORM-0816 | 1/2 BSPPM x 1 ORFSM |
| BPM-ORM-0819 | 1/2 BSPPM x 1-3/16 ORFSM |
| BPM-ORM-1213 | 3/4 BSPPM x 13/16 ORFSM |
| BPM-ORM-1216 | 3/4 BSPPM x 1 ORFSM |
| BPM-ORM-1219 | 3/4 BSPPM x 1-3/16 ORFSM |
| BPM-ORM-1223 | 3/4 BSPPM x 1-7/16 ORFSM |
| BPM-ORM-1619 | 1 BSPPM x 1-3/16 ORFSM |
| BPM-ORM-1623 | 1 BSPPM x 1-7/16 ORFSM |
| BPM-ORM-1627 | 1 BSPPM x 1-11/16 ORFSM |
| BPM-ORM-2023 | 1-1/4 BSPPM x 1-7/16 ORFSM |
| BPM-ORM-2027 | 1-1/4 BSPPM x 1-11/16 ORFSM |
| BPM-ORM-2432 | 1-1/2 BSPPM x 2 ORFSM |

BSPP Male Tube Weld

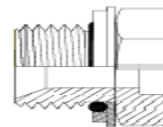

| | |
|--------------|---------------------------------|
| BPM-TWF-0404 | 1/4 BSPPM x 1/4 OD Tubeweld |
| BPM-TWF-0406 | 1/4 BSPPM x 3/8 OD Tubeweld |
| BPM-TWF-0606 | 3/8 BSPPM x 3/8 OD Tubeweld |
| BPM-TWF-0608 | 3/8 BSPPM x 1/2 OD Tubeweld |
| BPM-TWF-0808 | 1/2 BSPPM x 1/2 OD Tubeweld |
| BPM-TWF-0810 | 1/2 BSPPM x 5/8 OD Tubeweld |
| BPM-TWF-0812 | 1/2 BSPPM x 3/4 OD Tubeweld |
| BPM-TWF-1212 | 3/4 BSPPM x 3/4 OD Tubeweld |
| BPM-TWF-1216 | 3/4 BSPPM x 1 OD Tubeweld |
| BPM-TWF-1616 | 1 BSPPM x 1 OD Tubeweld |
| BPM-TWF-1620 | 1 BSPPM x 1-1/4 OD Tubeweld |
| BPM-TWF-2020 | 1-1/4 BSPPM x 1-1/4 OD Tubeweld |
| BPM-TWF-2420 | 1-1/2 BSPPM x 1-1/4 OD Tubeweld |
| BPM-TWF-2432 | 1-1/2 BSPPM x 2 OD Tubeweld |

BSPP Male x UNO Male Nipple

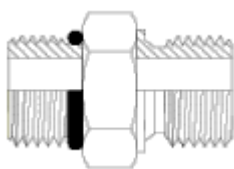

| | |
|--------------|--------------------------|
| BPM-UNM-0407 | 1/4 BSPPM x 7/16 UNOM |
| BPM-UNM-0408 | 1/4 BSPPM x 1/2 UNOM |
| BPM-UNM-0409 | 1/4 BSPPM x 9/16 UNOM |
| BPM-UNM-0412 | 1/4 BSPPM x 3/4 UNOM |
| BPM-UNM-0607 | 3/8 BSPPM x 7/16 UNOM |
| BPM-UNM-0608 | 3/8 BSPPM x 1/2 UNOM |
| BPM-UNM-0609 | 3/8 BSPPM x 9/16 UNOM |
| BPM-UNM-0612 | 3/8 BSPPM x 3/4 UNOM |
| BPM-UNM-0614 | 3/8 BSPPM x 7/8 UNOM |
| BPM-UNM-0809 | 1/2 BSPPM x 9/16 UNOM |
| BPM-UNM-0812 | 1/2 BSPPM x 3/4 UNOM |
| BPM-UNM-0814 | 1/2 BSPPM x 7/8 UNOM |
| BPM-UNM-0817 | 1/2 BSPPM x 1-1/16 UNOM |
| BPM-UNM-1212 | 3/4 BSPPM x 3/4 UNOM |
| BPM-UNM-1214 | 3/4 BSPPM x 7/8 UNOM |
| BPM-UNM-1217 | 3/4 BSPPM x 1-1/16 UNOM |
| BPM-UNM-1219 | 3/4 BSPPM x 1-3/16 UNOM |
| BPM-UNM-1221 | 3/4 BSPPM x 1-5/16 UNOM |
| BPM-UNM-1617 | 1 BSPPM x 1-1/16 UNOM |
| BPM-UNM-1619 | 1 BSPPM x 1-3/16 UNOM |
| BPM-UNM-1621 | 1 BSPPM x 1-5/16 UNOM |
| BPM-UNM-1626 | 1 BSPPM x 1-5/8 UNOM |
| BPM-UNM-2026 | 1-1/4 BSPPM x 1-5/8 UNOM |

BSPP Female Swivel x JIC Male

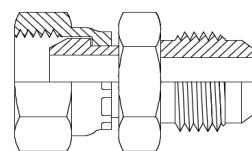

| | |
|--------------|-------------------------|
| BSF-JIM-0812 | 1/2 BSPFS x 3/4 JICM |
| BSF-JIM-1217 | 3/4 BSPFS x 1-1/16 JICM |
| BSF-JIM-1617 | 1 BSPFS x 1-1/16 JICM |

BSPP Female Swivel Tube Weld

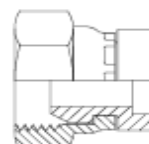

| | |
|--------------|---------------------------------|
| BSF-TWF-0404 | 1/4 BSPFS x 1/4 OD Tubeweld |
| BSF-TWF-0606 | 3/8 BSPFS x 3/8 OD Tubeweld |
| BSF-TWF-0608 | 3/8 BSPFS x 1/2 OD Tubeweld |
| BSF-TWF-0808 | 1/2 BSPFS x 1/2 OD Tubeweld |
| BSF-TWF-1212 | 3/4 BSPFS x 3/4 OD Tubeweld |
| BSF-TWF-1616 | 1 BSPFS x 1 OD Tubeweld |
| BSF-TWF-2020 | 1-1/4 BSPFS x 1-1/4 OD Tubeweld |
| BSF-TWF-2424 | 1-1/2 BSPFS x 1-1/2 OD Tubeweld |
| BSF-TWF-3232 | 2 BSPFS x 2 OD Tubeweld |

BSPP Female Swivel x BSPP Female Swivel

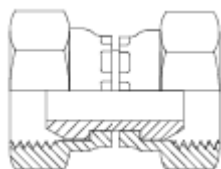

| | |
|--------------|-----------------------|
| BSF-BSF-0404 | 1/4 BSPFS x 1/4 BSPFS |
| BSF-BSF-0606 | 3/8 BSPFS x 3/8 BSPFS |
| BSF-BSF-0808 | 1/2 BSPFS x 1/2 BSPFS |
| BSF-BSF-1212 | 3/4 BSPFS x 3/4 BSPFS |
| BSF-BSF-1616 | 1 BSPFS x 1 BSPFS |

BSPP Female Swivel x UNO Male

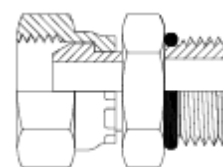

| | |
|--------------|--------------------------|
| BSF-UNM-0407 | 1/4 BSPTF x 7/16 UNOM |
| BSF-UNM-0409 | 1/4 BSPTF x 9/16 UNOM |
| BSF-UNM-0609 | 3/8 BSPFS x 9/16 UNOM |
| BSF-UNM-0612 | 3/8 BSPFS x 3/4 UNOM |
| BSF-UNM-0614 | 3/8 BSPFS x 7/8 UNOM |
| BSF-UNM-0812 | 1/2 BSPFS x 3/4 UNOM |
| BSF-UNM-0814 | 1/2 BSPFS x 7/8 UNOM |
| BSF-UNM-1217 | 3/4 BSPPFS x 1-1/16 UNOM |
| BSF-UNM-1617 | 1 BSPPFS x 1-1/16 UNOM |
| BSF-UNM-1621 | 1 BSPPFS x 1-5/16 UNOM |

BSPT Fixed Female x BSPP Female Swivel

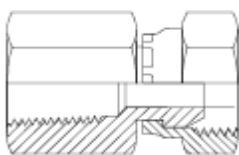

| | |
|--------------|-----------------------|
| BTF-BSF-0404 | 1/4 BSPTF x 1/4 BSPFS |
| BTF-BSF-0606 | 3/8 BSPTF x 3/8 BSPFS |
| BTF-BSF-0808 | 1/2 BSPTF x 1/2 BSPFS |
| BTF-BSF-1212 | 3/4 BSPTF x 3/4 BSPFS |
| BTF-BSF-1616 | 1 BSPTF x 1 BSPFS |

BSPT Female Socket

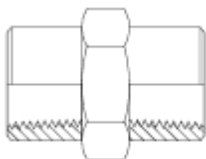

| | |
|--------------|------------------------------|
| BTF-BTF-0202 | 1/8 BSPTF Socket |
| BTF-BTF-0204 | 1/8 BSPTF x 1/4 BSPTF Socket |
| BTF-BTF-0206 | 1/8 BSPTF x 3/8 BSPTF Socket |
| BTF-BTF-0404 | 1/4 BSPTF Socket |
| BTF-BTF-0406 | 1/4 BSPTF x 3/8 BSPTF Socket |
| BTF-BTF-0408 | 1/4 BSPTF x 1/2 BSPTF Socket |
| BTF-BTF-0606 | 3/8 BSPTF Socket |
| BTF-BTF-0608 | 3/8 BSPTF x 1/2 BSPTF Socket |
| BTF-BTF-0612 | 3/8 BSPTF x 3/4 BSPTF Socket |
| BTF-BTF-0808 | 1/2 BSPTF Socket |
| BTF-BTF-0812 | 1/2 BSPTF x 3/4 BSPTF Socket |
| BTF-BTF-1212 | 3/4 BSPTF Socket |
| BTF-BTF-1216 | 3/4 BSPTF x 1 BSPTF Socket |
| BTF-BTF-1616 | 1 BSPTF Socket |
| BTF-BTF-1620 | 1 BSPTF x 1-1/4 BSPTF Socket |
| BTF-BTF-2020 | 1-1/4 BSPTF Socket |
| BTF-BTF-2424 | 1-1/2 BSPTF Socket |
| BTF-BTF-3232 | 2 BSPTF Socket |

BSPT Female Fixed x JIC Male

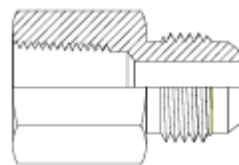

| | |
|--------------|-------------------------|
| BTF-JIM-0207 | 1/8 BSPTF X 7/16 JICM |
| BTF-JIM-0407 | 1/4 BSPTF X 7/16 JICM |
| BTF-JIM-0409 | 1/4 BSPTF X 9/16 JICM |
| BTF-JIM-0609 | 3/8 BSPTF X 9/16 JICM |
| BTF-JIM-0612 | 3/8 BSPTF X 3/4 JICM |
| BTF-JIM-0809 | 1/2 BSPT F x 9/16 JICM |
| BTF-JIM-0812 | 1/2 BSPTF X 3/4 JICM |
| BTF-JIM-0814 | 1/2 BSPTF X 7/8 JICM |
| BTF-JIM-0817 | 1/2 BSPTF X 1-1/16 JICM |
| BTF-JIM-1217 | 3/4 BSPTF X 1-1/16 JICM |
| BTF-JIM-1621 | 1 BSPTF X 1-5/16 JICM |

BSPT Male x JIS (BSP) Male Nipple

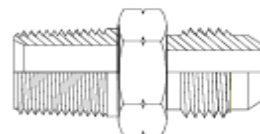

| | |
|--------------|-------------------------|
| BTM-BJM-0404 | 1/4 BSPTM x 1/4 JIS BSP |
| BTM-BJM-0606 | 3/8 BSPTM x 3/8 JIS BSP |
| BTM-BJM-0808 | 1/2 BSPTM x 1/2 JIS BSP |
| BTM-BJM-1212 | 3/4 BSPTM x 3/4 JIS BSP |
| BTM-BJM-1616 | 1 BSPTM x 1 JIS BSP |

BSPT Male x BSPP Female Swivel

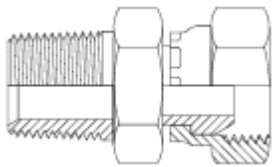

| | |
|--------------|---------------------------|
| BTM-BSF-0202 | 1/8 BSPTM x 1/8 BSPFS |
| BTM-BSF-0204 | 1/8 BSPTM x 1/4 BSPFS |
| BTM-BSF-0404 | 1/4 BSPTM x 1/4 BSPFS |
| BTM-BSF-0406 | 1/4 BSPTM x 3/8 BSPFS |
| BTM-BSF-0408 | 1/4 BSPTM x 1/2 BSPFS |
| BTM-BSF-0604 | 3/8 BSPTM x 1/4 BSPFS |
| BTM-BSF-0606 | 3/8 BSPTM x 3/8 BSPFS |
| BTM-BSF-0608 | 3/8 BSPTM x 1/2 BSPFS |
| BTM-BSF-0804 | 1/2 BSPTM X 1/4 BSPFS |
| BTM-BSF-0806 | 1/2 BSPTM x 3/8 BSPFS |
| BTM-BSF-0808 | 1/2 BSPTM x 1/2 BSPFS |
| BTM-BSF-0812 | 1/2 BSPTM x 3/4 BSPFS |
| BTM-BSF-1208 | 3/4 BSPTM x 1/2 BSPFS |
| BTM-BSF-1212 | 3/4 BSPTM x 3/4 BSPFS |
| BTM-BSF-1216 | 3/4 BSPTM x 1 BSPFS |
| BTM-BSF-1612 | 1 BSPTM x 3/4 BSPFS |
| BTM-BSF-1616 | 1 BSPTM x 1 BSPFS |
| BTM-BSF-1620 | 1 BSPTM x 1-1/4 BSPFS |
| BTM-BSF-2016 | 1-1/4 BSPTM x 1 BSPFS |
| BTM-BSF-2020 | 1-1/4 BSPTM x 1-1/4 BSPFS |
| BTM-BSF-2024 | 1-1/4 BSPTM x 1-1/2 BSPFS |
| BTM-BSF-2424 | 1-1/2 BSPTM X 1-1/2 BSPFS |
| BTM-BSF-3232 | 2 BSPTM X 2 BSPFS |

BSPT Male x BSPT Female Reducer/Expander

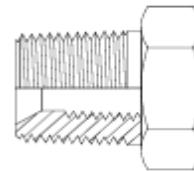

| | |
|--------------|---------------------------|
| BTM-BTF-0202 | 1/8 BSPTM x 1/8 BSPTF |
| BTM-BTF-0204 | 1/8 BSPTM X 1/4 BSPTF |
| BTM-BTF-0402 | 1/4 BSPTM x 1/8 BSPTF |
| BTM-BTF-0404 | 1/4 BSPTM X 1/4 BSPTF |
| BTM-BTF-0406 | 1/4 BSPTM X 3/8 BSPTF |
| BTM-BTF-0408 | 1/4 BSPTM X 1/2 BSPTF |
| BTM-BTF-0602 | 3/8 BSPTM x 1/8 BSPTF |
| BTM-BTF-0604 | 3/8 BSPTM x 1/4 BSPTF |
| BTM-BTF-0606 | 3/8 BSPTM X 3/8 BSPTF |
| BTM-BTF-0608 | 3/8 BSPTM x 1/2 BSPTF |
| BTM-BTF-0802 | 1/2 BSPTM x 1/8 BSPTF |
| BTM-BTF-0804 | 1/2 BSPTM x 1/4 BSPTF |
| BTM-BTF-0806 | 1/2 BSPTM x 3/8 BSPTF |
| BTM-BTF-0808 | 1/2 BSPTM x 1/2 BSPTF |
| BTM-BTF-0812 | 1/2 BSPTM X 3/4 BSPTF |
| BTM-BTF-1204 | 3/4 BSPTM x 1/4 BSPTF |
| BTM-BTF-1206 | 3/4 BSPTM x 3/8 BSPTF |
| BTM-BTF-1208 | 3/4 BSPTM x 1/2 BSPTF |
| BTM-BTF-1212 | 3/4 BSPTM X 3/4 BSPTF |
| BTM-BTF-1216 | 3/4 BSPTM X 1 BSPTF |
| BTM-BTF-1604 | 1 BSPTM x 1/4 BSPTF |
| BTM-BTF-1606 | 1 BSPTM x 3/8 BSPTF |
| BTM-BTF-1608 | 1 BSPTM x 1/2 BSPTF |
| BTM-BTF-1612 | 1 BSPTM x 3/4 BSPTF |
| BTM-BTF-1616 | 1 BSPTM X 1 BSPTF |
| BTM-BTF-1620 | 1 BSPTM X 1-1/4 BSPTF |
| BTM-BTF-2008 | 1-1/4 BSPTM x 1/2 BSPTF |
| BTM-BTF-2012 | 1-1/4 BSPTM x 3/4 BSPTF |
| BTM-BTF-2016 | 1-1/4 BSPTM x 1 BSPTF |
| BTM-BTF-2020 | 1-1/4 BSPTM x 1-1/4 BSPTF |
| BTM-BTF-2412 | 1-1/2 BSPTM x 3/4 BSPTF |
| BTM-BTF-2416 | 1-1/2 BSPTM x 1 BSPTF |
| BTM-BTF-2420 | 1-1/2 BSPTM x 1-1/4 BSPTF |
| BTM-BTF-3216 | 2 BSPTM x 1 BSPTF |
| BTM-BTF-3220 | 2 BSPTM x 1-1/4 BSPTF |
| BTM-BTF-3224 | 2 BSPTM x 1-1/2 BSPTF |

BSPT Male x BSPT Male Nipple

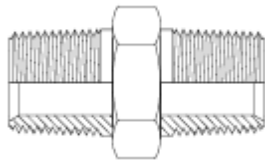

| | |
|--------------|---------------------------|
| BTM-BTM-0202 | 1/8 BSPTM x 1/8 BSPTM |
| BTM-BTM-0204 | 1/8 BSPTM x 1/4 BSPTM |
| BTM-BTM-0206 | 1/8 BSPTM x 3/8 BSPTM |
| BTM-BTM-0404 | 1/4 BSPTM x 1/4 BSPTM |
| BTM-BTM-0406 | 1/4 BSPTM x 3/8 BSPTM |
| BTM-BTM-0408 | 1/4 BSPTM x 1/2 BSPTM |
| BTM-BTM-0412 | 1/4 BSPTM x 3/4 BSPTM |
| BTM-BTM-0606 | 3/8 BSPTM x 3/8 BSPTM |
| BTM-BTM-0608 | 3/8 BSPTM x 1/2 BSPTM |
| BTM-BTM-0612 | 3/8 BSPTM x 3/4 BSPTM |
| BTM-BTM-0616 | 3/8 BSPTM x 1 BSPTM |
| BTM-BTM-0808 | 1/2 BSPTM x 1/2 BSPTM |
| BTM-BTM-0810 | 1/2 BSPTM x 5/8 BSPTM |
| BTM-BTM-0812 | 1/2 BSPTM x 3/4 BSPTM |
| BTM-BTM-0816 | 1/2 BSPTM x 1 BSPTM |
| BTM-BTM-1010 | 5/8 BSPTM x 5/8 BSPTM |
| BTM-BTM-1012 | 5/8 BSPTM x 3/4 BSPTM |
| BTM-BTM-1212 | 3/4 BSPTM x 3/4 BSPTM |
| BTM-BTM-1216 | 3/4 BSPTM x 1 BSPTM |
| BTM-BTM-1220 | 3/4 BSPTM x 1-1/4 BSPTM |
| BTM-BTM-1224 | 3/4 BSPTM x 1-1/2 BSPTM |
| BTM-BTM-1616 | 1 BSPTM x 1 BSPTM |
| BTM-BTM-1620 | 1 BSPTM x 1-1/4 BSPTM |
| BTM-BTM-1624 | 1 BSPTM x 1-1/2 BSPTM |
| BTM-BTM-2020 | 1-1/4 BSPTM x 1-1/4 BSPTM |
| BTM-BTM-2024 | 1-1/4 BSPTM x 1-1/2 BSPTM |
| BTM-BTM-2032 | 1-1/4 BSPTM x 2 BSPTM |
| BTM-BTM-2424 | 1-1/2 BSPTM x 1-1/2 BSPTM |
| BTM-BTM-2432 | 1-1/2 BSPTM x 2 BSPTM |
| BTM-BTM-3232 | 2 BSPTM x 2 BSPTM |

BSPT Male x JIC Female Swivel

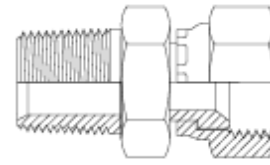

| | |
|--------------|---------------------------|
| BTM-JIF-0207 | 1/8 BSPTM x 7/16 JICFS |
| BTM-JIF-0407 | 1/4 BSPTM x 7/16 JICFS |
| BTM-JIF-0409 | 1/4 BSPTM x 9/16 JICFS |
| BTM-JIF-0609 | 3/8 BSPTM x 9/16 JICFS |
| BTM-JIF-0612 | 3/8 BSPTM x 3/4 JICFS |
| BTM-JIF-0614 | 3/8 BSPTM x 7/8 JICFS |
| BTM-JIF-0809 | 1/2 BSPTM x 9/16 JICFS |
| BTM-JIF-0812 | 1/2 BSPTM x 3/4 JICFS |
| BTM-JIF-0814 | 1/2 BSPTM x 7/8 JICFS |
| BTM-JIF-0817 | 1/2 BSPTM X 1-1/16 JICFS |
| BTM-JIF-1217 | 3/4 BSPTM x 1-1/16 JICFS |
| BTM-JIF-1221 | 3/4 BSPTM X 1-5/16 JICFS |
| BTM-JIF-1617 | 1 BSPTM x 1-1/16 JICFS |
| BTM-JIF-1621 | 1 BSPTM x 1-5/16 JICFS |
| BTM-JIF-2026 | 1-1/4 BSPTM X 1-5/8 JICFS |

BSPT Male x JIC Male Nipple

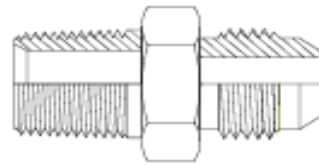

| | |
|--------------|---------------------------|
| BTM-JIM-0207 | 1/8 BSPTM x 7/16 JICM |
| BTM-JIM-0208 | 1/8 BSPTM x 1/2 JICM |
| BTM-JIM-0209 | 1/8 BSPTM x 9/16 JICM |
| BTM-JIM-0407 | 1/4 BSPTM x 7/16 JICM |
| BTM-JIM-0408 | 1/4 BSPTM x 1/2 JICM |
| BTM-JIM-0409 | 1/4 BSPTM x 9/16 JICM |
| BTM-JIM-0412 | 1/4 BSPTM x 3/4 JICM |
| BTM-JIM-0607 | 3/8 BSPTM x 7/16 JICM |
| BTM-JIM-0608 | 3/8 BSPTM X 1/2 JICM |
| BTM-JIM-0609 | 3/8 BSPTM x 9/16 JICM |
| BTM-JIM-0612 | 3/8 BSPTM x 3/4 JICM |
| BTM-JIM-0614 | 3/8 BSPTM x 7/8 JICM |
| BTM-JIM-0617 | 3/8 BSPTM X 1-1/16 JICM |
| BTM-JIM-0807 | 1/2 BSPTM x 7/16 JICM |
| BTM-JIM-0809 | 1/2 BSPTM x 9/16 JICM |
| BTM-JIM-0812 | 1/2 BSPTM x 3/4 JICM |
| BTM-JIM-0814 | 1/2 BSPTM X 7/8 JICM |
| BTM-JIM-0817 | 1/2 BSPTM x 1-1/16 JICM |
| BTM-JIM-0821 | 1/2 BSPTM-1-5/16 JICM |
| BTM-JIM-1209 | 3/4 BSPTM x 9/16 JICM |
| BTM-JIM-1212 | 3/4 BSPTM x 3/4 JICM |
| BTM-JIM-1214 | 3/4 BSPTM x 7/8 JICM |
| BTM-JIM-1217 | 3/4 BSPTM x 1-1/16 JICM |
| BTM-JIM-1219 | 3/4 BSPTM x 1-3/16 JICM |
| BTM-JIM-1221 | 3/4 BSPTM x 1-5/16 JICM |
| BTM-JIM-1612 | 1 BSPTM x 3/4 JICM |
| BTM-JIM-1614 | 1 BSPTM x 7/8 JICM |
| BTM-JIM-1617 | 1 BSPTM x 1-1/16 JICM |
| BTM-JIM-1619 | 1 BSPTM x 1-3/16 JICM |
| BTM-JIM-1621 | 1 BSPTM x 1-5/16 JICM |
| BTM-JIM-1626 | 1 BSPTM x 1-5/8 JICM |
| BTM-JIM-2017 | 1-1/4 BSPTM x 1-1/16 JICM |
| BTM-JIM-2021 | 1-1/4 BSPTM x 1-5/16 JICM |
| BTM-JIM-2026 | 1-1/4 BSPTM x 1-5/8 JICM |
| BTM-JIM-2030 | 1-1/4 BSPTM x 1-7/8 JICM |
| BTM-JIM-2421 | 1-1/2 BSPTM x 1-5/16 JICM |
| BTM-JIM-2426 | 1-1/2 BSPTM x 1-5/8 JICM |
| BTM-JIM-2430 | 1-1/2 BSPTM x 1-7/8 JICM |
| BTM-JIM-2440 | 1-1/2 BSPTM x 2-1/2 JICM |
| BTM-JIM-3226 | 2 BSPTM x 1-5/8 JICM |
| BTM-JIM-3230 | 2 BSPTM X 1-7/8 JICM |
| BTM-JIM-3240 | 2 BSPTM x 2-1/2 JICM |

BSPT Male x Chinese Metric Male Nipple

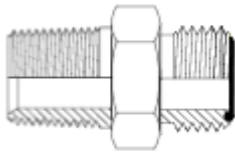

| | |
|--------------|------------------------------|
| BTM-MCM-0414 | 1/4 BSPTM x 14MM Flat Face M |
| BTM-MCM-0416 | 1/4 BSPTM x 16MM Flat Face M |
| BTM-MCM-0614 | 3/8 BSPTM x 14MM Flat Face M |
| BTM-MCM-0616 | 3/8 BSPTM x 16MM Flat Face M |
| BTM-MCM-0618 | 3/8 BSPTM x 18MM Flat Face M |
| BTM-MCM-0816 | 1/2 BSPTM x 16MM Flat Face M |
| BTM-MCM-0818 | 1/2 BSPTM x 18MM Flat Face M |

BSPT Male x NPT Female

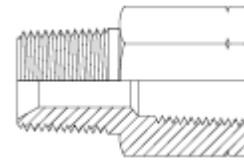

| | |
|--------------|----------------------|
| BTM-NTF-0202 | 1/8 BSPTM x 1/8 NPTF |
| BTM-NTF-0404 | 1/4 BSPTM x 1/4 NPTF |
| BTM-NTF-0606 | 3/8 BSPTM x 3/8 NPTF |
| BTM-NTF-0808 | 1/2 BSPTM x 1/2 NPTF |
| BTM-NTF-1212 | 3/4 BSPTM x 3/4 NPTF |
| BTM-NTF-1616 | 1 BSPTM x 1 NPTF |

BSPT Male x JIS Metric Male (Komatsu)

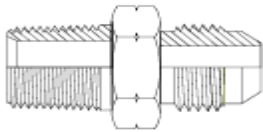

| | |
|--------------|-----------------------------|
| BTM-MKM-0414 | 1/4 BSPTM x 14mm JIS Metric |
| BTM-MKM-0616 | 3/8 BSPTM x 16mm JIS Metric |
| BTM-MKM-0618 | 3/8 BSPTM x 18mm JIS Metric |
| BTM-MKM-0818 | 1/2 BSPTM x 18mm JIS Metric |
| BTM-MKM-0820 | 1/2 BSPTM x 20mm JIS Metric |
| BTM-MKM-0822 | 1/2 BSPTM x 22mm JIS Metric |
| BTM-MKM-0824 | 1/2 BSPTM x 24mm JIS Metric |
| BTM-MKM-1224 | 3/4 BSPTM x 24mm JIS Metric |
| BTM-MKM-1230 | 3/4 BSPTM x 30mm JIS Metric |
| BTM-MKM-1633 | 1 BSPTM x 33mm JIS Metric |

BSPT Male x NPT Male Nipple

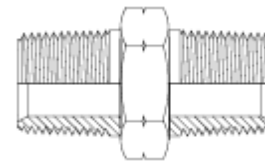

| | |
|--------------|--------------------------|
| BTM-NTM-0404 | 1/4 BSPTM x 1/4 NPTM |
| BTM-NTM-0606 | 3/8 BSPTM x 3/8 NPTM |
| BTM-NTM-0808 | 1/2 BSPTM x 1/2 NPTM |
| BTM-NTM-1212 | 3/4 BSPTM x 3/4 NPTM |
| BTM-NTM-1616 | 1 BSPTM x 1 NPTM |
| BTM-NTM-2020 | 1-1/4 BSPTM x 1-1/4 NPTM |
| BTM-NTM-2424 | 1-1/2 BSPTM x 1-1/2 NPTM |
| BTM-NTM-3232 | 2 BSPTM x 2 NPTM |

BSPT Male x Metric Stud Male Nipple

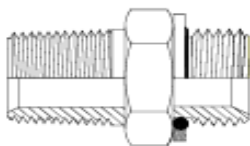

| | |
|--------------|------------------------------|
| BTM-MSM-0210 | 1/8 BSPTM x 14mm Metric Stud |
| BTM-MSM-0412 | 1/4 BSPTM x 12mm Metric Stud |
| BTM-MSM-0414 | 1/4 BSPTM x 14mm Metric Stud |
| BTM-MSM-0416 | 1/4 BSPTM x 16mm Metric Stud |
| BTM-MSM-0620 | 3/8 BSPTM x 20mm Metric Stud |
| BTM-MSM-0822 | 1/2 BSPTM x 22mm Metric Stud |
| BTM-MSM-0826 | 1/2 BSPTM x 26mm Metric Stud |
| BTM-MSM-0827 | 1/2 BSPTM x 27mm Metric Stud |
| BTM-MSM-1226 | 3/4 BSPTM x 26mm Metric Stud |

BSPT Male x ORFS Male Nipple

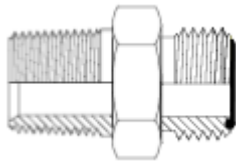

| | |
|--------------|--------------------------|
| BTM-ORM-0209 | 1/8 BSPTM x 9/16 ORFSM |
| BTM-ORM-0211 | 1/8 BSPTM x 11/16 ORFSM |
| BTM-ORM-0409 | 1/4 BSPTM x 9/16 ORFSM |
| BTM-ORM-0411 | 1/4 BSPTM X 11/16 ORFSM |
| BTM-ORM-0413 | 1/4 BSPTM X 13/16 ORFSM |
| BTM-ORM-0609 | 3/8 BSPTM x 9/16 ORFSM |
| BTM-ORM-0611 | 3/8 BSPTM x 11/16 ORFSM |
| BTM-ORM-0613 | 3/8 BSPTM X 13/16 ORFSM |
| BTM-ORM-0809 | 1/2 BSPTM x 9/16 ORFSM |
| BTM-ORM-0811 | 1/2 BSPTM x 11/16 ORFSM |
| BTM-ORM-0813 | 1/2 BSPTM x 13/16 ORFSM |
| BTM-ORM-0816 | 1/2 BSPTM x 1 ORFSM |
| BTM-ORM-0819 | 1/2 BSPTM x 1-3/16 ORFSM |
| BTM-ORM-1213 | 3/4 BSPTM x 13/16 ORFSM |
| BTM-ORM-1216 | 3/4 BSPTM x 1 ORFSM |
| BTM-ORM-1219 | 3/4 BSPTM x 1-3/16 ORFSM |
| BTM-ORM-1223 | 3/4 BSPTM X 1-7/16 ORFSM |
| BTM-ORM-1619 | 1 BSPTM x 1-3/16 ORFSM |
| BTM-ORM-1623 | 1 BSPTM x 1-7/16 ORFSM |

BSPT Male x SAE Male

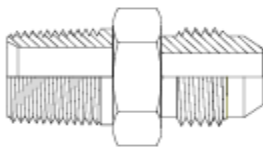

| | |
|--------------|----------------------|
| BTM-SAM-0410 | 1/4 BSPTM x 5/8 SAEM |
| BTM-SAM-0610 | 3/8 BSPTM x 5/8 SAEM |

BSPT Male Tube Weld

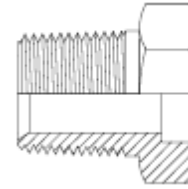

| | |
|--------------|---------------------------------|
| BTM-TWF-0404 | 1/4 BSPTM x 1/4 OD Tubeweld |
| BTM-TWF-0406 | 1/4 BSPTM x 3/8 OD Tubeweld |
| BTM-TWF-0604 | 3/8 BSPTM x 1/4 OD Tubeweld |
| BTM-TWF-0606 | 3/8 BSPTM x 3/8 OD Tubeweld |
| BTM-TWF-0608 | 3/8 BSPTM x 1/2 OD Tubeweld |
| BTM-TWF-0808 | 1/2 BSPTM x 1/2 OD Tubeweld |
| BTM-TWF-0810 | 1/2 BSPTM x 5/8 OD Tubeweld |
| BTM-TWF-0812 | 1/2 BSPTM x 3/4 OD Tubeweld |
| BTM-TWF-1212 | 3/4 BSPTM x 3/4 OD Tubeweld |
| BTM-TWF-1216 | 3/4 BSPTM x 1 OD Tubeweld |
| BTM-TWF-1616 | 1 BSPTM x 1 OD Tubeweld |
| BTM-TWF-1620 | 1 BSPTM x 1-1/4 OD Tubeweld |
| BTM-TWF-2020 | 1-1/4 BSPTM x 1-1/4 OD Tubeweld |
| BTM-TWF-2424 | 1-1/2 BSPTM x 1-1/2 OD Tubeweld |
| BTM-TWF-3232 | 2 BSPTM x 2 OD Tubeweld |

BSPT Male x UNO Female

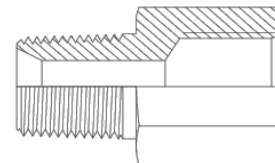

| | |
|--------------|----------------------|
| BTM-UNF-0812 | 1/2 BSPTM x 3/4 UNOF |
| BTM-UNF-0814 | 1/2 BSPTM x 7/8 UNOF |

BSPT Male x UNO Male Nipple

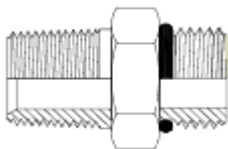

| | |
|--------------|---------------------------|
| BTM-UNM-0407 | 1/4 BSPTM x 7/16 UNOM |
| BTM-UNM-0408 | 1/4 BSPTM x 1/2 UNOM |
| BTM-UNM-0409 | 1/4 BSPTM x 9/16 UNOM |
| BTM-UNM-0412 | 1/4 BSPTM x 3/4 UNOM |
| BTM-UNM-0414 | 1/4 BSPTM x 7/8 UNOM |
| BTM-UNM-0607 | 3/8 BSPTM x 7/16 UNOM |
| BTM-UNM-0609 | 3/8 BSPTM x 9/16 UNOM |
| BTM-UNM-0612 | 3/8 BSPTM x 3/4 UNOM |
| BTM-UNM-0614 | 3/8 BSPTM x 7/8 UNOM |
| BTM-UNM-0809 | 1/2 BSPTM x 9/16 UNOM |
| BTM-UNM-0812 | 1/2 BSPTM x 3/4 UNOM |
| BTM-UNM-0814 | 1/2 BSPTM x 7/8 UNOM |
| BTM-UNM-0817 | 1/2 BSPTM x 1-1/16 UNOM |
| BTM-UNM-0821 | 1/2 BSPTM x 1-5/16 UNOM |
| BTM-UNM-1212 | 3/4 BSPTM x 3/4 UNOM |
| BTM-UNM-1214 | 3/4 BSPTM x 7/8 UNOM |
| BTM-UNM-1217 | 3/4 BSPTM x 1-1/16 UNOM |
| BTM-UNM-1221 | 3/4 BSPTM x 1-5/16 UNOM |
| BTM-UNM-1617 | 1 BSPTM x 1-1/16 UNOM |
| BTM-UNM-1621 | 1 BSPTM x 1-5/16 UNOM |
| BTM-UNM-1626 | 1 BSPTM x 1-5/8 UNOM |
| BTM-UNM-2021 | 1-1/4 BSPTM x 1-5/16 UNOM |
| BTM-UNM-2026 | 1-1/4 BSPTM x 1-5/8 UNOM |
| BTM-UNM-2030 | 1-1/4 BSPTM x 1-7/8 UNOM |
| BTM-UNM-2426 | 1-1/2 BSPTM x 1-5/8 UNOM |
| BTM-UNM-2430 | 1-1/2 BSPTM x 1-7/8 UNOM |

JIC Female Swivel x JIC Female Swivel



| | |
|--------------|-----------------------------|
| JIF-JIF-0707 | 7/16 JICFS x 7/16 JICFS |
| JIF-JIF-0909 | 9/16 JICFS x 9/16 JICFS |
| JIF-JIF-1212 | 3/4 JICFS x 3/4 JICFS |
| JIF-JIF-1414 | 7/8 JICFS x 7/8 JICFS |
| JIF-JIF-1717 | 1-1/16 JICFS x 1-1/16 JICFS |
| JIF-JIF-2121 | 1-5/16 JICFS x 1-5/16 JICFS |
| JIF-JIF-2626 | 1-5/8 JICFS x 1-5/8 JICFS |
| JIF-JIF-3030 | 1-7/8 JICFS x 1-7/8 JICFS |

JIC Female Swivel x ORFS Male

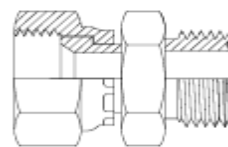

| | |
|--------------|-----------------------------|
| JIF-ORM-0709 | 7/16 JICFS x 9/16 ORFSM |
| JIF-ORM-0911 | 9/16 JICFS x 11/16 ORFSM |
| JIF-ORM-1213 | 3/4 JICFS x 13/16 ORFSM |
| JIF-ORM-1416 | 7/8 JICFS x 1 ORFSM |
| JIF-ORM-1719 | 1-1/16 JICFS x 1-3/16 ORFSM |
| JIF-ORM-2123 | 1-5/16 JICFS x 1-7/16 ORFSM |

JIC Female Swivel Tube Weld

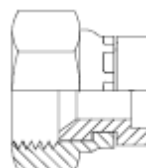

| | |
|--------------|----------------------------------|
| JIF-TWF-0704 | 7/16 JICFS x 1/4 OD Tubeweld |
| JIF-TWF-0904 | 9/16 JICFS x 1/4 OD Tubeweld |
| JIF-TWF-0906 | 9/16 JICFS x 3/8 OD Tubeweld |
| JIF-TWF-1206 | 3/4 JICFS x 3/8 OD Tubeweld |
| JIF-TWF-1208 | 3/4 JICFS x 1/2 OD Tubeweld |
| JIF-TWF-1210 | 3/4 JICFS x 5/8 OD Tubeweld |
| JIF-TWF-1408 | 7/8 JICFS x 1/2 OD Tubeweld |
| JIF-TWF-1410 | 7/8 JICFS x 5/8 OD Tubeweld |
| JIF-TWF-1712 | 1-1/16 JICFS x 3/4 OD Tubeweld |
| JIF-TWF-1716 | 1-1/16 JICFS x 1 OD Tubeweld |
| JIF-TWF-2116 | 1-5/16 JICFS x 1 OD Tubeweld |
| JIF-TWF-2120 | 1-5/16 JICFS x 1-1/4 OD Tubeweld |
| JIF-TWF-2620 | 1-5/8 JICFS x 1-1/4 OD Tubeweld |
| JIF-TWF-3024 | 1-7/8 JICFS x 1-1/2 OD Tubeweld |

JIC Female Swivel x UNO Male

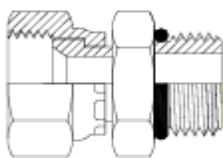

| | |
|--------------|----------------------------|
| JIF-UNM-0707 | 7/16 JICFS x 7/16 UNOM |
| JIF-UNM-0909 | 9/16 JICFS x 9/16 UNOM |
| JIF-UNM-0912 | 9/16 JICFS x 3/4 UNOM |
| JIF-UNM-1209 | 3/4 JICFS x 9/16 UNOM |
| JIF-UNM-1212 | 3/4 JICFS x 3/4 UNOM |
| JIF-UNM-1214 | 3/4 JICFS x 7/8 UNOM |
| JIF-UNM-1217 | 3/4 JICFS x 1-1/16 UNOM |
| JIF-UNM-1412 | 7/8 JICFS x 3/4 UNOM |
| JIF-UNM-1414 | 7/8 JICFS x 7/8 UNOM |
| JIF-UNM-1717 | 1-1/16 JICFS x 1-1/16 UNOM |
| JIF-UNM-2121 | 1-5/16 JICFS x 1-5/16 UNOM |
| JIF-UNM-2626 | 1-5/8 JICFS x 1-5/8 UNOM |

JIC Male x Code 62 Flange

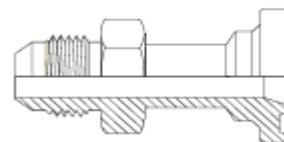

| | |
|--------------|--------------------------------|
| JIM-F62-1208 | 3/4 JICM x 1/2 C62 Flange |
| JIM-F62-1212 | 3/4 JICM x 3/4 C62 Flange |
| JIM-F62-1712 | 1-1/16 JICM x 3/4 C62 Flange |
| JIM-F62-1716 | 1-1/16 JICM x 1 C62 Flange |
| JIM-F62-2112 | 1-5/16 JICM x 3/4 C62 Flange |
| JIM-F62-2116 | 1-5/16 JICM x 1 C62 Flange |
| JIM-F62-2120 | 1-5/16 JICM x 1-1/4 C62 Flange |
| JIM-F62-2124 | 1-5/16 JICM x 1-1/2 C62 Flange |
| JIM-F62-2616 | 1-5/8 JICM x 1 C62 Flange |
| JIM-F62-2620 | 1-5/8 JICM x 1-1/4 C62 Flange |
| JIM-F62-2624 | 1-5/8 JICM x 1-1/2 C62 Flange |
| JIM-F62-3024 | 1-7/8 JICM x 1-1/2 C62 Flange |

JIC Male x Code 61 Flange

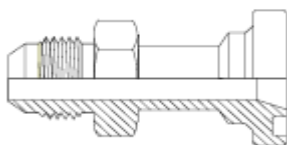

| | |
|--------------|--------------------------------|
| JIM-F61-1208 | 3/4 JICM x 1/2 C61 Flange |
| JIM-F61-1212 | 3/4 JICM x 3/4 C61 Flange |
| JIM-F61-1412 | 7/8 JICM x 3/4 C61 Flange |
| JIM-F61-1712 | 1-1/16 JICM x 3/4 C61 Flange |
| JIM-F61-1716 | 1-1/16 JICM x 1 C61 Flange |
| JIM-F61-1720 | 1-1/16 JICM x 1-1/4 C61 Flange |
| JIM-F61-2112 | 1-5/16 JICM x 3/4 C61 Flange |
| JIM-F61-2116 | 1-5/16 JICM x 1 C61 Flange |
| JIM-F61-2120 | 1-5/16 JICM x 1-1/4 C61 Flange |
| JIM-F61-2124 | 1-5/16 JICM x 1-1/2 C61 Flange |
| JIM-F61-2132 | 1-5/16 JICM x 2 C61 Flange |
| JIM-F61-2616 | 1-5/8 JICM x 1 C61 Flange |
| JIM-F61-2620 | 1-5/8 JICM x 1-1/4 C61 Flange |
| JIM-F61-2624 | 1-5/8 JICM x 1-1/2 C61 Flange |
| JIM-F61-2632 | 1-5/8 JICM x 2 C61 Flange |
| JIM-F61-3024 | 1-7/8 JICM x 1-1/2 C61 Flange |
| JIM-F61-3032 | 1-7/8 JICM x 2 C61 Flange |
| JIM-F61-4032 | 2-1/2 JICM x 2 C61 Flange |

JIC Male x JIC Fixed Female

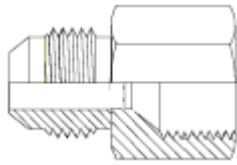

| | |
|--------------|---------------------------|
| JIM-JFF-0706 | 7/16 JICM x 3/8 JICF |
| JIM-JFF-0708 | 7/16 JICM x 1/2 JICF |
| JIM-JFF-0709 | 7/16 JICM x 9/16 JICF |
| JIM-JFF-0712 | 7/16 JICM x 3/4 JICF |
| JIM-JFF-0714 | 7/16 JICM x 7/8 JICF |
| JIM-JFF-0717 | 7/16 JICM X 1-1/16 JICF |
| JIM-JFF-0721 | 7/16 JICM x 1-5/16 JICF |
| JIM-JFF-0809 | 1/2 JICM x 9/16 JICF |
| JIM-JFF-0907 | 9/16 JICM x 7/16 JICF |
| JIM-JFF-0908 | 9/16 JICM x 1/2 JICF |
| JIM-JFF-0909 | 9/16 JICM x 9/16 JICF |
| JIM-JFF-0912 | 9/16 JICM x 3/4 JICF |
| JIM-JFF-0914 | 9/16 JICM x 7/8 JICF |
| JIM-JFF-0917 | 9/16 JICM x 1-1/16 JICF |
| JIM-JFF-0921 | 9/16 JICM x 1-5/16 JICF |
| JIM-JFF-1207 | 3/4 JICM x 7/16 JICF |
| JIM-JFF-1209 | 3/4 JICM x 9/16 JICF |
| JIM-JFF-1214 | 3/4 JICM x 7/8 JICF |
| JIM-JFF-1217 | 3/4 JICM x 1-1/16 JICF |
| JIM-JFF-1221 | 3/4 JICM x 1-5/16 JICF |
| JIM-JFF-1409 | 7/8 JICM x 9/16 JICF |
| JIM-JFF-1412 | 7/8 JICM x 3/4 JICF |
| JIM-JFF-1417 | 7/8 JICM x 1-1/16 JICF |
| JIM-JFF-1421 | 7/8 JICM x 1-5/16 JICF |
| JIM-JFF-1709 | 1-1/16 JICM x 9/16 JICF |
| JIM-JFF-1712 | 1-1/16 JICM x 3/4 JICF |
| JIM-JFF-1714 | 1-1/16 JICM x 7/8 JICF |
| JIM-JFF-1719 | 1-1/16 JICM x 1-3/16 JICF |
| JIM-JFF-1721 | 1-1/16 JICM x 1-5/16 JICF |
| JIM-JFF-1726 | 1-1/16 JICM x 1-5/8 JICF |
| JIM-JFF-2114 | 1-5/16 JICM x 7/8 JICF |
| JIM-JFF-2117 | 1-5/16 JICM x 1-1/16 JICF |
| JIM-JFF-2126 | 1-5/16 JICM x 1-5/8 JICF |
| JIM-JFF-2130 | 1-5/16 JICM x 1-7/8 JICF |
| JIM-JFF-2621 | 1-5/8 JICM x 1-5/16 JICF |
| JIM-JFF-2630 | 1-5/8 JICM x 1-7/8 JICF |
| JIM-JFF-3026 | 1-7/8 JICM x 1-5/8 JICF |
| JIM-JFF-3040 | 1-7/8 JICM x 2-1/2 JICF |
| JIM-JFF-4030 | 2-1/2 JICM x 1-7/8 JICF |

JIC Male x JIC Female Swivel

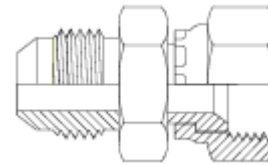

| | |
|--------------|----------------------------|
| JIM-JIF-0707 | 7/16 JICM x 7/16 JICFS |
| JIM-JIF-0709 | 7/16 JICM x 9/16 JICFS |
| JIM-JIF-0712 | 7/16 JICM x 3/4 JICFS |
| JIM-JIF-0808 | 1/2 JICM x 1/2 JICFS |
| JIM-JIF-0809 | 1/2 JICM x 9/16 JICFS |
| JIM-JIF-0907 | 9/16 JICM x 7/16 JICFS |
| JIM-JIF-0909 | 9/16 JICM x 9/16 JICFS |
| JIM-JIF-0912 | 9/16 JICM x 3/4 JICFS |
| JIM-JIF-0914 | 9/16 JICM x 7/8 JICFS |
| JIM-JIF-1209 | 3/4 JICM x 9/16 JICFS |
| JIM-JIF-1212 | 3/4 JICM x 3/4 JICFS |
| JIM-JIF-1214 | 3/4 JICM x 7/8 JICFS |
| JIM-JIF-1217 | 3/4 JICM x 1-1/16 JICFS |
| JIM-JIF-1221 | 3/4 JICM x 1-5/16 JICFS |
| JIM-JIF-1409 | 7/8 JICM x 9/16 JICFS |
| JIM-JIF-1412 | 7/8 JICM x 3/4 JICFS |
| JIM-JIF-1414 | 7/8 JICM x 7/8 JICFS |
| JIM-JIF-1417 | 7/8 JICM x 1-1/16 JICFS |
| JIM-JIF-1712 | 1-1/16 JICM x 3/4 JICFS |
| JIM-JIF-1714 | 1-1/16 JICM x 7/8 JICFS |
| JIM-JIF-1717 | 1-1/16 JICM x 1-1/16 JICFS |
| JIM-JIF-1721 | 1-1/16 JICM x 1-5/16 JICFS |
| JIM-JIF-2117 | 1-5/16 JICM x 1-1/16 JICFS |
| JIM-JIF-2121 | 1-5/16 JICM x 1-5/16 JICFS |
| JIM-JIF-2126 | 1-5/16 JICM x 1-5/8 JICFS |
| JIM-JIF-2621 | 1-5/8 JICM x 1-5/16 JICFS |
| JIM-JIF-2626 | 1-5/8 JICM x 1-5/8 JICFS |
| JIM-JIF-2630 | 1-5/8 JICM x 1-7/8 JICFS |
| JIM-JIF-3026 | 1-7/8 JICM x 1-5/8 JICFS |
| JIM-JIF-3030 | 1-7/8 JICM x 1-7/8 JICFS |
| JIM-JIF-4040 | 2-1/2 JICM x 2-1/2 JICFS |

JIC Male x JIC Male Nipple

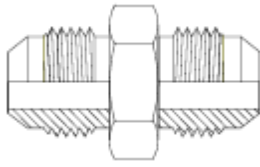

| | |
|--------------|---------------------------|
| JIM-JIM-0606 | 3/8 JICM x 3/8 JICM |
| JIM-JIM-0707 | 7/16 JICM x 7/16 JICM |
| JIM-JIM-0708 | 7/16 JICM x 1/2 JICM |
| JIM-JIM-0709 | 7/16 JICM x 9/16 JICM |
| JIM-JIM-0712 | 7/16 JICM x 3/4 JICM |
| JIM-JIM-0714 | 7/16 JICM x 7/8 JICM |
| JIM-JIM-0808 | 1/2 JICM x 1/2 JICM |
| JIM-JIM-0809 | 1/2 JICM x 9/16 JICM |
| JIM-JIM-0909 | 9/16 JICM x 9/16 JICM |
| JIM-JIM-0912 | 9/16 JICM x 3/4 JICM |
| JIM-JIM-0914 | 9/16 JICM x 7/8 JICM |
| JIM-JIM-0917 | 9/16 JICM x 1-1/16 JICM |
| JIM-JIM-1212 | 3/4 JICM x 3/4 JICM |
| JIM-JIM-1214 | 3/4 JICM x 7/8 JICM |
| JIM-JIM-1217 | 3/4 JICM x 1-1/16 JICM |
| JIM-JIM-1414 | 7/8 JICM x 7/8 JICM |
| JIM-JIM-1417 | 7/8 JICM x 1-1/16 JICM |
| JIM-JIM-1717 | 1-1/16 JICM x 1-1/16 JICM |
| JIM-JIM-1719 | 1-1/16 JICM x 1-3/16 JICM |
| JIM-JIM-1721 | 1-1/16 JICM x 1-5/16 JICM |
| JIM-JIM-1919 | 1-3/16 JICM x 1-3/16 JICM |
| JIM-JIM-2121 | 1-5/16 JICM x 1-5/16 JICM |
| JIM-JIM-2126 | 1-5/16 JICM x 1-5/8 JICM |
| JIM-JIM-2626 | 1-5/8 JICM x 1-5/8 JICM |
| JIM-JIM-2630 | 1-5/8 JICM x 1-7/8 JICM |
| JIM-JIM-3030 | 1-7/8 JICM x 1-7/8 JICM |
| JIM-JIM-4040 | 2-1/2 JICM x 2-1/2 JICM |

JIC Male x Metric Male Stud Nipple

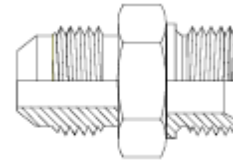

| | |
|--------------|--------------------------------|
| JIM-MSM-0708 | 7/16 JICM x 8mm Metric Stud |
| JIM-MSM-0710 | 7/16 JICM x 10mm Metric Stud |
| JIM-MSM-0712 | 7/16 JICM x 12mm Metric Stud |
| JIM-MSM-0714 | 7/16 JICM x 14mm Metric Stud |
| JIM-MSM-0716 | 7/16 JICM x 16mm Metric Stud |
| JIM-MSM-0810 | 1/2 JICM x 10mm Metric Stud |
| JIM-MSM-0912 | 9/16 JICM x 12mm Metric Stud |
| JIM-MSM-0914 | 9/16 JICM x 14mm Metric Stud |
| JIM-MSM-0916 | 9/16 JICM x 16mm Metric Stud |
| JIM-MSM-0918 | 9/16 JICM x 18mm Metric Stud |
| JIM-MSM-0920 | 9/16 JICM x 20mm Metric Stud |
| JIM-MSM-0922 | 9/16 JICM x 22mm Metric Stud |
| JIM-MSM-1212 | 3/4 JICM x 12mm Metric Stud |
| JIM-MSM-1214 | 3/4 JICM x 14mm Metric Stud |
| JIM-MSM-1216 | 3/4 JICM x 16mm Metric Stud |
| JIM-MSM-1218 | 3/4 JICM x 18mm Metric Stud |
| JIM-MSM-1220 | 3/4 JICM x 20mm Metric Stud |
| JIM-MSM-1222 | 3/4 JICM x 22mm Metric Stud |
| JIM-MSM-1226 | 3/4 JICM x 26mm Metric Stud |
| JIM-MSM-1416 | 7/8 JICM x 16mm Metric Stud |
| JIM-MSM-1418 | 7/8 JICM x 18mm Metric Stud |
| JIM-MSM-1420 | 7/8 JICM x 20mm Metric Stud |
| JIM-MSM-1422 | 7/8 JICM x 22mm Metric Stud |
| JIM-MSM-1426 | 7/8 JICM x 26mm Metric Stud |
| JIM-MSM-1718 | 1-1/16 JICM x 18mm Metric Stud |
| JIM-MSM-1720 | 1-1/16 JICM x 20mm Metric Stud |
| JIM-MSM-1722 | 1-1/16 JICM x 22mm Metric Stud |
| JIM-MSM-1726 | 1-1/16 JICM x 26mm Metric Stud |
| JIM-MSM-1727 | 1-1/16 JICM x 27mm Metric Stud |
| JIM-MSM-1728 | 1-1/16 JICM x 28mm Metric Stud |
| JIM-MSM-1733 | 1-1/16 JICM x 33mm Metric Stud |
| JIM-MSM-2126 | 1-5/16 JICM x 26mm Metric Stud |
| JIM-MSM-2127 | 1-5/16 JICM x 27mm Metric Stud |
| JIM-MSM-2133 | 1-5/16 JICM x 33mm Metric Stud |
| JIM-MSM-2142 | 1-5/16 JICM x 42mm Metric Stud |
| JIM-MSM-2633 | 1-5/8 JICM x 33mm Metric Stud |
| JIM-MSM-2642 | 1-5/8 JICM x 42mm Metric Stud |
| JIM-MSM-2648 | 1-5/8 JICM x 48mm Metric Stud |
| JIM-MSM-3042 | 1-7/8 JICM x 42mm Metric Stud |

JIC Male x ORFS Female

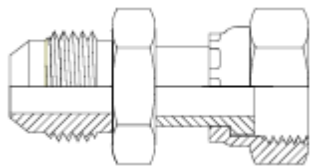

| | |
|--------------|----------------------------|
| JIM-ORF-0709 | 7/16 JICM x 9/16 ORFSF |
| JIM-ORF-0911 | 9/16 JICM x 11/16 ORFSF |
| JIM-ORF-1213 | 3/4 JICM x 13/16 ORFSF |
| JIM-ORF-1416 | 7/8 JICM x 1 ORFSF |
| JIM-ORF-1719 | 1-1/16 JICM x 1-3/16 ORFSF |
| JIM-ORF-2123 | 1-5/16 JICM x 1-7/16 ORFSF |
| JIM-ORF-2627 | 1-5/8 JICM x 1-11/16 ORFSF |

JIC Male Tube Weld

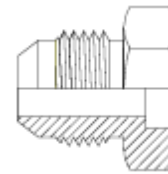

| | |
|--------------|---------------------------------|
| JIM-TWF-0704 | 7/16 JICM x 1/4 OD Tubeweld |
| JIM-TWF-0706 | 7/16 JICM x 3/8 OD Tubeweld |
| JIM-TWF-0906 | 9/16 JICM x 3/8 OD Tubeweld |
| JIM-TWF-1208 | 3/4 JICM x 1/2 OD Tubeweld |
| JIM-TWF-1212 | 3/4 JICM x 3/4 OD Tubeweld |
| JIM-TWF-1408 | 7/8 JICM x 1/2 OD Tubeweld |
| JIM-TWF-1410 | 7/8 JICM x 5/8 OD Tubeweld |
| JIM-TWF-1712 | 1-1/16 JICM x 3/4 OD Tubeweld |
| JIM-TWF-1716 | 1-1/16 JICM x 1 OD Tubeweld |
| JIM-TWF-2116 | 1-5/16 JICM x 1 OD Tubeweld |
| JIM-TWF-2120 | 1-5/16 JICM x 1-1/4 OD Tubeweld |
| JIM-TWF-2124 | 1-5/16 JICM x 1-1/2 OD Tubeweld |
| JIM-TWF-2620 | 1-5/8 JICM x 1-1/4 OD Tubeweld |
| JIM-TWF-2624 | 1-5/8 JICM x 1-1/2 OD Tubeweld |
| JIM-TWF-3024 | 1-7/8 JICM x 1-1/2 O D Tubeweld |

JIC Male x ORFS Male Nipple

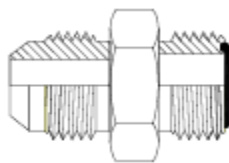

| | |
|--------------|-----------------------------|
| JIM-ORM-0709 | 7/16 JICM x 9/16 ORFSM |
| JIM-ORM-0911 | 9/16 JICM x 11/16 ORFSM |
| JIM-ORM-1213 | 3/4 JICM x 13/16 ORFSM |
| JIM-ORM-1413 | 7/8 JICM x 13/16 ORFSM |
| JIM-ORM-1416 | 7/8 JICM x 1 ORFSM |
| JIM-ORM-1719 | 1-1/16 JICM x 1-3/16 ORFSM |
| JIM-ORM-2119 | 1-5/16 JICM x 1-3/16 ORFSM |
| JIM-ORM-2123 | 1-5/16 JICM x 1-7/16 ORFSM |
| JIM-ORM-2127 | 1-5/16 JICM x 1-11/16 ORFSM |
| JIM-ORM-2627 | 1-5/8 JICM x 1-11/16 ORFSM |

JIC Male x UNO Male Nipple

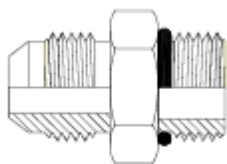

| | |
|---------------|---------------------------|
| JIM-UNM-0707 | 7/16 JICM x 7/16 UNOM |
| JIM-UNM-0707E | 7/16 JICM x 7/16 UNOM EXT |
| JIM-UNM-0708 | 7/16 JICM x 1/2 UNOM |
| JIM-UNM-0709 | 7/16 JICM x 9/16 UNOM |
| JIM-UNM-0712 | 7/16 JICM x 3/4 UNOM |
| JIM-UNM-0717 | 7/16 JICM x 1-1/16 UNOM |
| JIM-UNM-0721 | 7/16 JICM x 1-5/16 UNOM |
| JIM-UNM-0807 | 1/2 JICM x 7/16 UNOM |
| JIM-UNM-0808 | 1/2 JICM x 1/2 UNOM |
| JIM-UNM-0809 | 1/2 JICM x 9/16 UNOM |
| JIM-UNM-0812 | 1/2 JICM x 3/4 UNOM |
| JIM-UNM-0907 | 9/16 JICM x 7/16 UNOM |
| JIM-UNM-0908 | 9/16 JICM x 1/2 UNOM |
| JIM-UNM-0909 | 9/16 JICM x 9/16 UNOM |
| JIM-UNM-0909E | 9/16 JICM x 9/16 UNOM EXT |
| JIM-UNM-0912 | 9/16 JICM x 3/4 UNOM |
| JIM-UNM-0914 | 9/16 JICM x 7/8 UNOM |
| JIM-UNM-0917 | 9/16 JICM x 1-1/16 UNOM |
| JIM-UNM-0921 | 9/16 JICM x 1-5/16 UNOM |
| JIM-UNM-1207 | 3/4 JICM x 7/16 UNOM |
| JIM-UNM-1208 | 3/4 JICM x 1/2 UNOM |
| JIM-UNM-1209 | 3/4 JICM x 9/16 UNOM |
| JIM-UNM-1212 | 3/4 JICM x 3/4 UNOM |
| JIM-UNM-1212E | 3/4 JICM x 3/4 UNOM EXT |
| JIM-UNM-1214 | 3/4 JICM x 7/8 UNOM |
| JIM-UNM-1217 | 3/4 JICM x 1-1/16 UNOM |
| JIM-UNM-1221 | 3/4 JICM x 1-5/16 UNOM |
| JIM-UNM-1409 | 7/8 JICM x 9/16 UNOM |
| JIM-UNM-1412 | 7/8 JICM x 3/4 UNOM |
| JIM-UNM-1414 | 7/8 JICM x 7/8 UNOM |
| JIM-UNM-1417 | 7/8 JICM x 1-1/16 UNOM |
| JIM-UNM-1421 | 7/8 JICM x 1-5/16 UNOM |
| JIM-UNM-1426 | 7/8 JICM x 1-5/8 UNOM |
| JIM-UNM-1712 | 1-1/16 JICM x 3/4 UNOM |
| JIM-UNM-1714 | 1-1/16 JICM x 7/8 UNOM |
| JIM-UNM-1717 | 1-1/16 JICM x 1-1/16 UNOM |
| JIM-UNM-1719 | 1-1/16 JICM x 1-3/16 UNOM |
| JIM-UNM-1721 | 1-1/16 JICM x 1-5/16 UNOM |
| JIM-UNM-1726 | 1-1/16 JICM x 1-5/8 UNOM |

| | |
|--------------|---------------------------|
| JIM-UNM-1919 | 1-3/16 JICM x 1-3/16 UNOM |
| JIM-UNM-2112 | 1-5/16 JICM x 3/4 UNOM |
| JIM-UNM-2114 | 1-5/16 JICM x 7/8 UNOM |
| JIM-UNM-2117 | 1-5/16 JICM x 1-1/16 UNOM |
| JIM-UNM-2121 | 1-5/16 JICM x 1-5/16 UNOM |
| JIM-UNM-2126 | 1-5/16 JICM x 1-5/8 UNOM |
| JIM-UNM-2130 | 1-5/16 JICM x 1-7/8 UNOM |
| JIM-UNM-2614 | 1-5/8 JICM x 7/8 UNOM |
| JIM-UNM-2617 | 1-5/8 JICM x 1-1/16 UNOM |
| JIM-UNM-2621 | 1-5/8 JICM x 1-5/16 UNOM |
| JIM-UNM-2626 | 1-5/8 JICM x 1-5/8 UNOM |
| JIM-UNM-2630 | 1-5/8 JICM x 1-7/8 UNOM |
| JIM-UNM-3026 | 1-7/8 JICM x 1-5/8 UNOM |
| JIM-UNM-3030 | 1-7/8 JICM x 1-7/8 UNOM |
| JIM-UNM-3040 | 1-7/8 JICM x 2-1/2 UNOM |
| JIM-UNM-4040 | 2-1/2 JICM x 2-1/2 UNOM |

JIS Metric Male x JIS Metric Male (Komatsu) Nipple

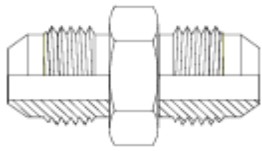

| | |
|--------------|---------------------------|
| MKM-MKM-1414 | 14mm JIS Metric (Komatsu) |
| MKM-MKM-1616 | 16mm JIS Metric (Komatsu) |
| MKM-MKM-1818 | 18mm JIS Metric (Komatsu) |
| MKM-MKM-2020 | 20mm JIS Metric (Komatsu) |
| MKM-MKM-2222 | 22mm JIS Metric (Komatsu) |
| MKM-MKM-2424 | 24mm JIS Metric (Komatsu) |
| MKM-MKM-2626 | 26mm JIS Metric (Komatsu) |
| MKM-MKM-2727 | 27mm JIS Metric (Komatsu) |
| MKM-MKM-3030 | 30mm JIS Metric (Komatsu) |
| MKM-MKM-3333 | 33mm JIS Metric (Komatsu) |
| MKM-MKM-3636 | 36mm JIS Metric (Komatsu) |
| MKM-MKM-4242 | 42mm JIS Metric (Komatsu) |

NPT Female x JIC Male

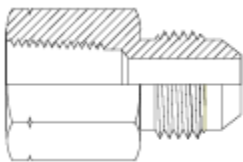

| | |
|--------------|-------------------------|
| NTF-JIM-0207 | 1/8 NPTF x 7/16 JICM |
| NTF-JIM-0208 | 1/8 NPTF x 1/2 JICM |
| NTF-JIM-0209 | 1/8 NPTF x 9/16 JICM |
| NTF-JIM-0407 | 1/4 NPTF x 7/16 JICM |
| NTF-JIM-0408 | 1/4 NPTF x 1/2 JICM |
| NTF-JIM-0409 | 1/4 NPTF x 9/16 JICM |
| NTF-JIM-0609 | 3/8 NPTF x 9/16 JICM |
| NTF-JIM-0612 | 3/8 NPTF x 3/4 JICM |
| NTF-JIM-0809 | 1/2 NPTF x 9/16 JICM |
| NTF-JIM-0812 | 1/2 NPTF x 3/4 JICM |
| NTF-JIM-0814 | 1/2 NPTF x 7/8 JICM |
| NTF-JIM-0817 | 1/2 NPTF x 1-1/16 JICM |
| NTF-JIM-1214 | 3/4 NPTF x 7/8 JICM |
| NTF-JIM-1217 | 3/4 NPTF x 1-1/16 JICM |
| NTF-JIM-1621 | 1 NPTF x 1-5/16 JICM |
| NTF-JIM-2026 | 1-1/4 NPTF x 1-5/8 JICM |

NPT Female x NPT Female Swivel

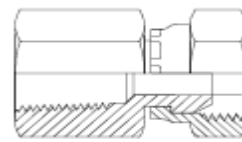

| | |
|--------------|----------------------|
| NTF-NSF-0404 | 1/4 NPTF x 1/4 NPTSF |
| NTF-NSF-0604 | 3/8 NPTF x 1/4 NPTSF |
| NTF-NSF-0606 | 3/8 NPTF x 3/8 NPTSF |
| NTF-NSF-0808 | 1/2 NPTF x 1/2 NPTSF |
| NTF-NSF-1212 | 3/4 NPTF x 3/4 NPTSF |
| NTF-NSF-1616 | 1 NPTF x 1 NPTSF |

NPT Female Socket

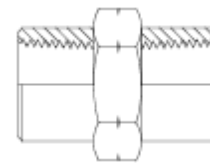

| | |
|--------------|----------------------------|
| NTF-NTF-0202 | 1/8 NPTF Socket |
| NTF-NTF-0204 | 1/8 NPTF X 1/4 NPTF Socket |
| NTF-NTF-0404 | 1/4 NPTF Socket |
| NTF-NTF-0406 | 1/4 NPTF x 3/8 NPTF Socket |
| NTF-NTF-0408 | 1/4 NPTF x 1/2 NPTF Socket |
| NTF-NTF-0606 | 3/8 NPTF Socket |
| NTF-NTF-0608 | 3/8 NPTF x 1/2 NPTF Socket |
| NTF-NTF-0808 | 1/2 NPTF Socket |
| NTF-NTF-0812 | 1/2 NPTF x 3/4 NPTF Socket |
| NTF-NTF-1212 | 3/4 NPTF Socket |
| NTF-NTF-1216 | 3/4 NPTF x 1 NPTF Socket |
| NTF-NTF-1616 | 1 NPTF Socket |
| NTF-NTF-2020 | 1-1/4 NPTF Socket |
| NTF-NTF-2424 | 1-1/2 NPTF Socket |
| NTF-NTF-3232 | 2 NPTF Socket |

NPT Male x JIC Female Swivel

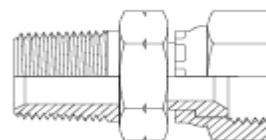

| | |
|--------------|-----------------------|
| NTM-JIF-0207 | 1/8 NPTM x 7/16 JICFS |
| NTM-JIF-0407 | 1/4 NPTM x 7/16 JICFS |
| NTM-JIF-0409 | 1/4 NPTM x 9/16 JICFS |
| NTM-JIF-0607 | 3/8 NPTM x 7/16 JICFS |
| NTM-JIF-0609 | 3/8 NPTM x 9/16 JICFS |
| NTM-JIF-0612 | 3/8 NPTM x 3/4 JICFS |

NPT Male x JIC Male Nipple

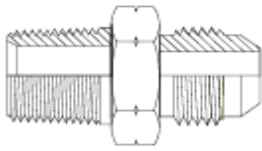

| | |
|--------------|--------------------------|
| NTM-JIM-0206 | 1/8 NPTM x 3/8 JICM |
| NTM-JIM-0207 | 1/8 NPTM x 7/16 JICM |
| NTM-JIM-0208 | 1/8 NPTM x 1/2 JICM |
| NTM-JIM-0209 | 1/8 NPTM x 9/16 JICM |
| NTM-JIM-0406 | 1/4 NPTM x 3/8 JICM |
| NTM-JIM-0407 | 1/4 NPTM x 7/16 JICM |
| NTM-JIM-0408 | 1/4 NPTM x 1/2 JICM |
| NTM-JIM-0409 | 1/4 NPTM x 9/16 JICM |
| NTM-JIM-0412 | 1/4 NPTM x 3/4 JICM |
| NTM-JIM-0607 | 3/8 NPTM x 7/16 JICM |
| NTM-JIM-0609 | 3/8 NPTM x 9/16 JICM |
| NTM-JIM-0612 | 3/8 NPTM x 3/4 JICM |
| NTM-JIM-0614 | 3/8 NPTM x 7/8 JICM |
| NTM-JIM-0617 | 3/8 NPTM x 1-1/16 JICM |
| NTM-JIM-0807 | 1/2 NPTM x 7/16 JICM |
| NTM-JIM-0809 | 1/2 NPTM x 9/16 JICM |
| NTM-JIM-0812 | 1/2 NPTM x 3/4 JICM |
| NTM-JIM-0814 | 1/2 NPTM x 7/8 JICM |
| NTM-JIM-0817 | 1/2 NPTM x 1-1/16 JICM |
| NTM-JIM-0821 | 1/2 NPTM x 1-5/16 JICM |
| NTM-JIM-1209 | 3/4 NPTM x 9/16 JICM |
| NTM-JIM-1212 | 3/4 NPTM x 3/4 JICM |
| NTM-JIM-1214 | 3/4 NPTM x 7/8 JICM |
| NTM-JIM-1217 | 3/4 NPTM x 1-1/16 JICM |
| NTM-JIM-1221 | 3/4 NPTM x 1-5/16 JICM |
| NTM-JIM-1226 | 3/4 NPTM x 1-5/8 JICM |
| NTM-JIM-1612 | 1 NPTM x 3/4 JICM |
| NTM-JIM-1614 | 1 NPTM x 7/8 JICM |
| NTM-JIM-1617 | 1 NPTM x 1-1/16 JICM |
| NTM-JIM-1621 | 1 NPTM x 1-5/16 JICM |
| NTM-JIM-1626 | 1 NPTM x 1-5/8 JICM |
| NTM-JIM-2017 | 1-1/4 NPTM x 1-1/16 JICM |
| NTM-JIM-2021 | 1-1/4 NPTM x 1-5/16 JICM |
| NTM-JIM-2026 | 1-1/4 NPTM x 1-5/8 JICM |
| NTM-JIM-2030 | 1-1/4 NPTM x 1-7/8 JICM |
| NTM-JIM-2421 | 1-1/2 NPTM x 1-5/16 JICM |
| NTM-JIM-2426 | 1-1/2 NPTM x 1-5/8 JICM |
| NTM-JIM-2430 | 1-1/2 NPTM x 1-7/8 JICM |
| NTM-JIM-2440 | 1-1/2 NPTM x 2-1/2 JICM |
| NTM-JIM-3230 | 2 NPTM x 1-7/8 JICM |

| | |
|--------------|---------------------|
| NTM-JIM-3240 | 2 NPTM x 2-1/2 JICM |
|--------------|---------------------|

NPT Male x NPT Female Swivel

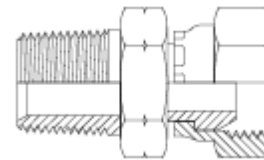

| | |
|--------------|--------------------------|
| NTM-NSF-0202 | 1/8 NPTM x 1/8 NPTSF |
| NTM-NSF-0204 | 1/8 NPTM x 1/4 NPTSF |
| NTM-NSF-0404 | 1/4 NPTM x 1/4 NPTSF |
| NTM-NSF-0406 | 1/4 NPTM x 3/8 NPTSF |
| NTM-NSF-0604 | 3/8 NPTM x 1/4 NPTSF |
| NTM-NSF-0606 | 3/8 NPTM x 3/8 NPTSF |
| NTM-NSF-0808 | 1/2 NPTM x 1/2 NPTSF |
| NTM-NSF-0812 | 1/2 NPTM x 3/4 NPTSF |
| NTM-NSF-1208 | 3/4 NPTM x 1/2 NPTSF |
| NTM-NSF-1212 | 3/4 NPTM x 3/4 NPTSF |
| NTM-NSF-1216 | 3/4 NPTM x 1 NPTSF |
| NTM-NSF-1612 | 1 NPTM x 3/4 NPTSF |
| NTM-NSF-1616 | 1 NPTM x 1 NPTSF |
| NTM-NSF-2016 | 1-1/4 NPTM x 1 NPTSF |
| NTM-NSF-2020 | 1-1/4 NPTM x 1-1/4 NPTSF |
| NTM-NSF-2424 | 1-1/2 NPTM x 1-1/2 NPTSF |
| NTM-NSF-3232 | 2 NPTM x 2 NPTSF |

NPT Male x NPT Female Reducer/Expander

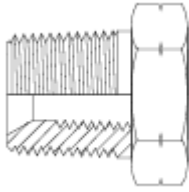

| | |
|--------------|-------------------------|
| NTM-NTF-0202 | 1/8 NPTM x 1/8 NPTF |
| NTM-NTF-0204 | 1/2 NPTM x 1/4 NPTF |
| NTM-NTF-0206 | 1/2 NPTM x 3/8 NPTF |
| NTM-NTF-0402 | 1/4 NPTM x 1/8 NPTF |
| NTM-NTF-0404 | 1/4 NPTM x 1/4 NPTF |
| NTM-NTF-0406 | 1/4 NPTM x 3/8 NPTF |
| NTM-NTF-0408 | 1/4 NPTM x 1/2 NPTF |
| NTM-NTF-0602 | 3/8 NPTM x 1/8 NPTF |
| NTM-NTF-0604 | 3/8 NPTM x 1/4 NPTF |
| NTM-NTF-0606 | 3/8 NPTM x 3/8 NPTF |
| NTM-NTF-0608 | 3/8 NPTM x 1/2 NPTF |
| NTM-NTF-0802 | 1/2 NPTM x 1/8 NPTF |
| NTM-NTF-0804 | 1/2 NPTM x 1/4 NPTF |
| NTM-NTF-0806 | 1/2 NPTM x 3/8 NPTF |
| NTM-NTF-0808 | 1/2 NPTM x 1/2 NPTF |
| NTM-NTF-0812 | 1/2 NPTM x 3/4 NPTF |
| NTM-NTF-1202 | 3/4 NPTM x 1/8 NPTF |
| NTM-NTF-1204 | 3/4 NPTM x 1/4 NPTF |
| NTM-NTF-1206 | 3/4 NPTM x 3/8 NPTF |
| NTM-NTF-1208 | 3/4 NPTM x 1/2 NPTF |
| NTM-NTF-1212 | 3/4 NPTM x 3/4 NPTF |
| NTM-NTF-1216 | 3/4 NPTM x 1 NPTF |
| NTM-NTF-1606 | 1 NPTM x 3/8 NPTF |
| NTM-NTF-1608 | 1 NPTM x 1/2 NPTF |
| NTM-NTF-1612 | 1 NPTM x 3/4 NPTF |
| NTM-NTF-1616 | 1 NPTM x 1 NPTF |
| NTM-NTF-2012 | 1-1/4 NPTM x 3/4 NPTF |
| NTM-NTF-2016 | 1-1/4 NPTM x 1 NPTF |
| NTM-NTF-2020 | 1-1/4 NPTM x 1-1/4 NPTF |
| NTM-NTF-2412 | 1-1/2 NPTM x 3/4 NPTF |
| NTM-NTF-2416 | 1-1/2 NPTM x 1 NPTF |
| NTM-NTF-2420 | 1-1/2 NPTM x 1-1/4 NPTF |
| NTM-NTF-3216 | 2 NPTM x 1 NPTF |
| NTM-NTF-3220 | 2 NPTM x 1-1/4 NPTF |
| NTM-NTF-3224 | 2 NPTM x 1-1/2 NPTF |

NPT Male x NPT Male Nipple

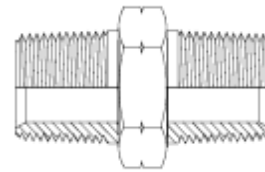

| | |
|--------------|-------------------------|
| NTM-NTM-0202 | 1/8 NPTM x 1/8 NPTM |
| NTM-NTM-0204 | 1/8 NPTM x 1/4 NPTM |
| NTM-NTM-0206 | 1/8 NPTM x 3/8 NPTM |
| NTM-NTM-0404 | 1/4 NPTM x 1/4 NPTM |
| NTM-NTM-0406 | 1/4 NPTM x 3/8 NPTM |
| NTM-NTM-0408 | 1/4 NPTM x 1/2 NPTM |
| NTM-NTM-0412 | 1/4 NPTM x 3/4 NPTM |
| NTM-NTM-0606 | 3/8 NPTM x 3/8 NPTM |
| NTM-NTM-0608 | 3/8 NPTM x 1/2 NPTM |
| NTM-NTM-0612 | 3/8 NPTM X 3/4 NPTM |
| NTM-NTM-0808 | 1/2 NPTM x 1/2 NPTM |
| NTM-NTM-0812 | 1/2 NPTM x 3/4 NPTM |
| NTM-NTM-0816 | 1/2 NPTM x 1 NPTM |
| NTM-NTM-1212 | 3/4 NPTM x 3/4 NPTM |
| NTM-NTM-1216 | 3/4 NPTM x 1 NPTM |
| NTM-NTM-1616 | 1 NPTM x 1 NPTM |
| NTM-NTM-1620 | 1 NPTM x 1-1/4 NPTM |
| NTM-NTM-1624 | 1 NPTM x 1-1/2 NPTM |
| NTM-NTM-2020 | 1-1/4 NPTM x 1-1/4 NPTM |
| NTM-NTM-2024 | 1-1/4 NPTM x 1-1/2 NPTM |
| NTM-NTM-2424 | 1-1/2 NPTM x 1-1/2 NPTM |
| NTM-NTM-3232 | 2 NPTM x 2 NPTM |

NPT Male x ORFS Male Nipple

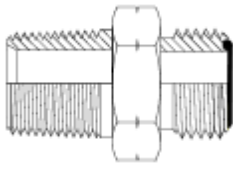

| | |
|--------------|----------------------------|
| NTM-ORM-0411 | 1/4 NPTM x 11/16 ORFSM |
| NTM-ORM-0611 | 3/8 NPTM x 11/16 ORFSM |
| NTM-ORM-0613 | 3/8 NPTM x 13/16 ORFSM |
| NTM-ORM-0809 | 1/2 NPTM x 9/16 ORFSM |
| NTM-ORM-0811 | 1/2 NPTM x 11/16 ORFSM |
| NTM-ORM-0813 | 1/2 NPTM x 13/16 ORFSM |
| NTM-ORM-0816 | 1/2 NPTM x 1 ORFSM |
| NTM-ORM-1213 | 3/4 NPTM x 13/16 ORFSM |
| NTM-ORM-1219 | 3/4 NPTM x 1-3/16 ORFSM |
| NTM-ORM-1223 | 3/4 NPTM x 1-7/16 ORFSM |
| NTM-ORM-1623 | 1 NPTM x 1-7/16 ORFSM |
| NTM-ORM-2027 | 1-1/4 NPTM x 1-11/16 ORFSM |

NPT Male x UNO Male Nipple

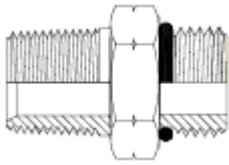

| | |
|--------------|------------------------|
| NTM-UNM-0609 | 3/8 NPTM x 9/16 UNOM |
| NTM-UNM-0612 | 3/8 NPTM x 3/4 UNOM |
| NTM-UNM-0614 | 3/8 NPTM x 7/8 UNOM |
| NTM-UNM-0812 | 1/2 NPTM x 3/4 UNOM |
| NTM-UNM-0814 | 1/2 NPTM x 7/8 UNOM |
| NTM-UNM-0817 | 1/2 NPTM x 3/4 UNOM |
| NTM-UNM-1212 | 3/4 NPTM x 3/4 UNOM |
| NTM-UNM-1214 | 3/4 NPTM x 7/8 UNOM |
| NTM-UNM-1217 | 3/4 NPTM x 1-1/16 UNOM |
| NTM-UNM-1621 | 1 NPTM x 1-5/16 UNOM |

Metric Male Stud x ORFS Male Nipple

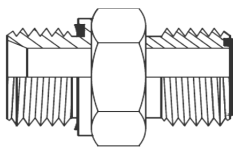

| | |
|--------------|----------------------------------|
| MSM-ORM-2213 | 22mm Metric Stud x 13/16 ORFSM |
| MSM-ORM-2216 | 22mm Metric Stud x 1 ORFSM |
| MSM-ORM-2219 | 22mm Metric Stud x 1-13/16 ORFSM |

ORFS Male x ORFS Female Swivel

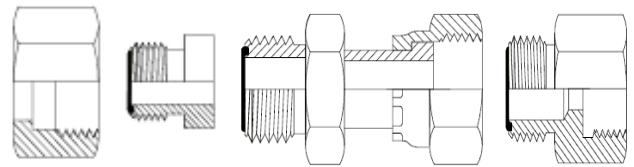

| | |
|--------------|------------------------------|
| ORM-ORF-0909 | 9/16 ORFSM x 9/16 ORFSF |
| ORM-ORF-0911 | 9/16 ORFSM x 11/16 ORFSF |
| ORM-ORF-0913 | 9/16 ORFSM x 13/16 ORFSF |
| ORM-ORF-0916 | 9/16 ORFSM x 1 ORFSF |
| ORM-ORF-0919 | 9/16 ORFSM x 1-3/16 ORFSF |
| ORM-ORF-1109 | 11/16 ORFSM x 9/16 ORFSF |
| ORM-ORF-1111 | 11/16 ORFSM x 11/16 ORFSF |
| ORM-ORF-1113 | 11/16 ORFSM x 13/16 ORFSF |
| ORM-ORF-1116 | 11/16 ORFSM x 1 ORFSF |
| ORM-ORF-1119 | 11/16 ORFSM x 1-3/16 ORFSF |
| ORM-ORF-1311 | 13/16 ORFSM x 11/16 ORFSF |
| ORM-ORF-1313 | 13/16 ORFSM x 13/16 ORFSF |
| ORM-ORF-1316 | 13/16 ORFSM x 1 ORFSF |
| ORM-ORF-1319 | 13/16 ORFS M x 1-3/16 ORFSF |
| ORM-ORF-1323 | 13/16 ORFSM x 1-7/16 ORFSF |
| ORM-ORF-1327 | 13/16 ORFSM x 1-11/16 ORFSF |
| ORM-ORF-1613 | 1 ORFSM x 13/16 ORFSF |
| ORM-ORF-1616 | 1 ORFSM x 1 ORFSF |
| ORM-ORF-1619 | 1 ORFSM x 1-3/16 ORFSF |
| ORM-ORF-1623 | 1 ORFSM x 1-7/16 ORFSF |
| ORM-ORF-1916 | 1-3/16 ORFSM x 1 ORFSF |
| ORM-ORF-1919 | 1-3/16 ORFSM x 1-3/16 ORFSF |
| ORM-ORF-1923 | 1-3/16 ORFSM x 1-7/16 ORFSF |
| ORM-ORF-1927 | 1-3/16 ORFSM x 1-11/16 ORFSF |
| ORM-ORF-2323 | 1-7/16 ORFSM x 1-7/16 ORFSF |
| ORM-ORF-2327 | 1-7/16 ORFSM x 1-11/16 ORFSF |
| ORM-ORF-2332 | 1-7/16 ORFSM x 2 ORFSF |
| ORM-ORF-2732 | 1-11/16 ORFSM x 2 ORFSF |

ORFS Male x ORFS Male Nipple

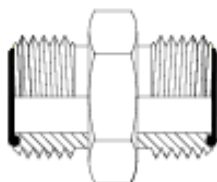

| | |
|--------------|-------------------------------|
| ORM-ORM-0909 | 9/16 ORFSM x 9/16 ORFSM |
| ORM-ORM-0911 | 9/16 ORFSM x 11/16 ORFSM |
| ORM-ORM-1111 | 11/16 ORFSM x 11/16 ORFSM |
| ORM-ORM-1113 | 11/16 ORFSM x 13/16 ORFSM |
| ORM-ORM-1313 | 13/16 ORFSM x 13/16 ORFSM |
| ORM-ORM-1316 | 13/16 ORFSM x 1 ORFSM |
| ORM-ORM-1319 | 13/16 ORFSM x 1-3/16 ORFSM |
| ORM-ORM-1616 | 1 ORFSM x 1 ORFSM |
| ORM-ORM-1619 | 1 ORFSM x 1-3/16 ORFSM |
| ORM-ORM-1919 | 1-3/16 ORFSM x 1-3/16 ORFSM |
| ORM-ORM-1923 | 1-3/16 ORFSM x 1-7/16 ORFSM |
| ORM-ORM-2323 | 1-7/16 ORFSM x 1-7/16 ORFSM |
| ORM-ORM-2327 | 1-7/16 ORFSM x 1-11/16 ORFSM |
| ORM-ORM-2727 | 1-11/16 ORFSM x 1-11/16 ORFSM |
| ORM-ORM-3232 | 2 ORFSM x 2 ORFSM |

ORFS Male x UNO Male Nipple

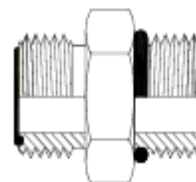

| | |
|--------------|-----------------------------|
| ORM-UNM-0907 | 9/16 ORFSM x 7/16 UNOM |
| ORM-UNM-0909 | 9/16 ORFSM x 9/16 UNOM |
| ORM-UNM-1107 | 11/16 ORFSM x 7/16 UNOM |
| ORM-UNM-1109 | 11/16 ORFSM x 9/16 UNOM |
| ORM-UNM-1112 | 11/16 ORFSM x 3/4 UNOM |
| ORM-UNM-1114 | 11/16 ORFSM x 7/8 UNOM |
| ORM-UNM-1309 | 13/16 ORFSM x 9/16 UNOM |
| ORM-UNM-1312 | 13/16 ORFSM x 3/4 UNOM |
| ORM-UNM-1314 | 13/16 ORFSM x 7/8 UNOM |
| ORM-UNM-1317 | 13/16 ORFSM x 1-1/16 UNOM |
| ORM-UNM-1321 | 13/16 ORFM x 1-5/16 UNOM |
| ORM-UNM-1612 | 1 ORFSM x 3/4 UNOM |
| ORM-UNM-1614 | 1 ORFSM x 7/8 UNOM |
| ORM-UNM-1617 | 1 ORFSM x 1-1/16 UNOM |
| ORM-UNM-1912 | 1-3/16 ORFSM x 3/4 UNOM |
| ORM-UNM-1914 | 1-3/16 ORFSM x 7/8 UNOM |
| ORM-UNM-1917 | 1-3/16 ORFSM x 1-1/16 UNOM |
| ORM-UNM-1921 | 1-3/16 ORFSM x 1-5/16 UNOM |
| ORM-UNM-2317 | 1-7/16 ORFSM x 1-1/16 UNOM |
| ORM-UNM-2321 | 1-7/16 ORFSM x 1-5/16 UNOM |
| ORM-UNM-2326 | 1-7/16 ORFSM x 1-5/8 UNOM |
| ORM-UNM-2721 | 1-11/16 ORFSM x 1-5/16 UNOM |
| ORM-UNM-2726 | 1-11/16 ORFS x 1-5/8 UNOM |
| ORM-UNM-2730 | 1-11/16 ORFS x 1-7/8 UNOM |
| ORM-UNM-3226 | 2 ORFS x 1-5/8 UNOM |
| ORM-UNM-3230 | 2 ORFS x 1-7/8 UNOM |

ORFS Male Tube Weld

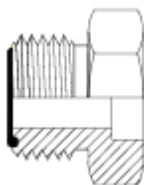

| | |
|--------------|-----------------------------------|
| ORM-TWF-0904 | 9/16 ORFSM x 1/4 OD Tubeweld |
| ORM-TWF-0906 | 9/16 ORFSM x 3/8 OD Tubeweld |
| ORM-TWF-1106 | 11/16 ORFSM x 3/8 OD Tubeweld |
| ORM-TWF-1308 | 13/16 ORFSM x 1/2 OD Tubeweld |
| ORM-TWF-1610 | 1 ORFSM x 5/8 OD Tubeweld |
| ORM-TWF-1912 | 1-3/16 ORFSM x 3/4 OD Tubeweld |
| ORM-TWF-1916 | 1-3/16 ORFSM x 1 OD Tubeweld |
| ORM-TWF-2316 | 1-7/16 ORFSM x 1 OD Tubeweld |
| ORM-TWF-2320 | 1-7/16 ORFSM x 1-1/4 OD Tubeweld |
| ORM-TWF-2324 | 1-7/16 ORFSM x 1-1/2 OD Tubeweld |
| ORM-TWF-2724 | 1-11/16 ORFSM x 1-1/2 OD Tubeweld |
| ORM-TWF-3232 | 2 ORFSM x 2 OD Tubeweld |

UNO Socket



| | |
|--------------|-------------------|
| UNF-UNF-0707 | 7/16 UNO Socket |
| UNF-UNF-0909 | 9/16 UNO Socket |
| UNF-UNF-1212 | 3/4 UNO Socket |
| UNF-UNF-1414 | 7/8 UNO Socket |
| UNF-UNF-1717 | 1-1/16 UNO Socket |
| UNF-UNF-2121 | 1-5/16 UNO Socket |

UNO Male x UNO Female Reducer/Expander

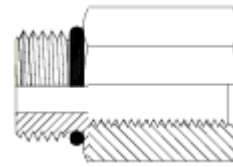

| | |
|--------------|---------------------------|
| UNM-UNF-0709 | 7/16 UNOM x 9/16 UNOF |
| UNM-UNF-0907 | 9/16 UNOM x 7/16 UNOF |
| UNM-UNF-1207 | 3/4 UNOM x 7/16 UNOF |
| UNM-UNF-1209 | 3/4 UNOM x 9/16 UNOF |
| UNM-UNF-1212 | 3/4 UNOM x 3/4 UNOF |
| UNM-UNF-1407 | 7/8 UNOM x 7/16 UNOF |
| UNM-UNF-1409 | 7/8 UNOM x 9/16 UNOF |
| UNM-UNF-1412 | 7/8 UNOM x 3/4 UNOF |
| UNM-UNF-1417 | 7/8 UNOM x 1-1/16 UNOF |
| UNM-UNF-1709 | 1-1/16 UNOM x 9/16 UNOF |
| UNM-UNF-1712 | 1-1/16 UNOM x 3/4 UNOF |
| UNM-UNF-1714 | 1-1/16 UNOM x 7/8 UNOF |
| UNM-UNF-2112 | 1-5/16 UNOM x 3/4 UNOF |
| UNM-UNF-2114 | 1-5/16 UNOM x 7/8 UNOF |
| UNM-UNF-2117 | 1-5/16 UNOM x 1-1/16 UNOF |
| UNM-UNF-2617 | 1-5/16 UNOM x 1-1/16 UNOF |
| UNM-UNF-2621 | 1-5/16 UNOM x 1-5/16 UNOF |
| UNM-UNF-3012 | 1-7/8 UNOM x 3/4 UNOF |
| UNM-UNF-3017 | 1-7/8 UNOM x 1-1/16 UNOF |
| UNM-UNF-3021 | 1-7/8 UNOM x 1-5/16 UNOF |

45 Degree Adaptors

BSPM Male x BSPT Male 45 Degree

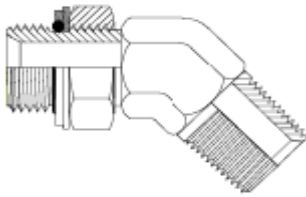

| | |
|------------------|---------------------------|
| BPM-BTM-45C-0404 | 1/4 BSPPM x 1/4 BSPTM 45° |
| BPM-BTM-45C-0606 | 3/8 BSPPM x 3/8 BSPTM 45° |
| BPM-BTM-45C-0808 | 1/2 BSPPM x 1/2 BSPTM 45° |
| BPM-BTM-45C-1212 | 3/4 BSPPM x 3/4 BSPTM 45° |
| BPM-BTM-45C-1616 | 1 BSPPM x 1 BSPTM 45° |

BSPM Male x JIC Male 45 Degree

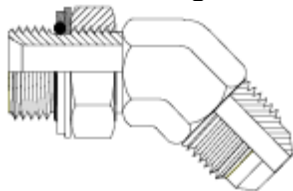

| | |
|------------------|------------------------------|
| BPM-JIM-45C-0407 | 1/4 BSPPM x 7/16 JICM 45° |
| BPM-JIM-45C-0409 | 1/4 BSPPM x 9/16 JICM 45° |
| BPM-JIM-45C-0609 | 3/8 BSPPM x 9/16 JICM 45° |
| BPM-JIM-45C-0612 | 3/8 BSPPM x 3/4 JICM 45° |
| BPM-JIM-45C-0809 | 1/2 BSPPM x 9/16 JICM 45° |
| BPM-JIM-45C-0812 | 1/2 BSPPM x 3/4 JICM 45° |
| BPM-JIM-45C-0814 | 1/2 BSPPM x 7/8 JICM 45° |
| BPM-JIM-45C-1212 | 3/4 BSPPM x 3/4 JICM 45° |
| BPM-JIM-45C-1217 | 3/4 BSPPM x 1-1/16 JICM 45° |
| BPM-JIM-45C-1617 | 1 BSPPM x 1-1/16 JICM 45° |
| BPM-JIM-45C-1621 | 1 BSPPM x 1-5/16 JICM 45° |
| BPM-JIM-45C-2026 | 1-1/4 BSPPM x 1-5/8 JICM 45° |
| BPM-JIM-45C-2430 | 1-1/2 BSPPM x 1-7/8 JICM 45° |

BSPM Male x ORFS Male 45 Degree

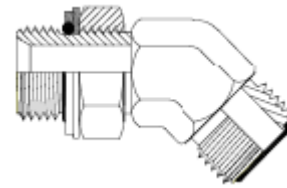

| | |
|------------------|------------------------------|
| BPM-ORM-45C-0409 | 1/4 BSPPM x 9/16 ORFSM 45° |
| BPM-ORM-45C-0411 | 1/4 BSPPM x 11/16 ORFSM 45° |
| BPM-ORM-45C-0611 | 3/8 BSPPM x 11/16 ORFSM 45° |
| BPM-ORM-45C-0613 | 3/8 BSPPM x 13/16 ORFSM 45° |
| BPM-ORM-45C-0811 | 1/2 BSPPM x 11/16 ORFSM 45° |
| BPM-ORM-45C-0813 | 1/2 BSPPM x 13/16 ORFSM 45° |
| BPM-ORM-45C-0816 | 1/2 BSPPM x 1 ORFSM 45° |
| BPM-ORM-45C-0819 | 1/2 BSPPM x 1-3/16 ORFSM 45° |
| BPM-ORM-45C-1219 | 3/4 BSPPM x 1-3/16 ORFSM 45° |
| BPM-ORM-45C-1623 | 1 BSPPM x 1-7/16 ORFSM 45° |

BSPT Female x BSPT Fixed Female 45 Degree



| | |
|------------------|---------------------------|
| BTF-BTF-45C-0202 | 1/8 BSPTF x 1/8 BSPTF 45° |
| BTF-BTF-45C-0404 | 1/4 BSPTF x 1/4 BSPTF 45° |
| BTF-BTF-45C-0606 | 3/8 BSPTF x 3/8 BSPTF 45° |
| BTF-BTF-45C-0808 | 1/2 BSPTF x 1/2 BSPTF 45° |
| BTF-BTF-45C-1212 | 3/4 BSPTF x 3/4 BSPTF 45° |
| BTF-BTF-45C-1616 | 1 BSPTF x 1 BSPTF 45° |

BSPT Male x BSPM Female Swivel 45 Degree

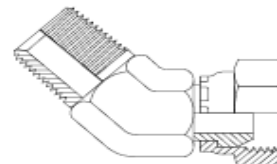

| | |
|------------------|-------------------------------|
| BTM-BSF-45C-0202 | 1/8 BSPTM x 1/8 BSPFS 45° |
| BTM-BSF-45C-0404 | 1/4 BSPTM x 1/4 BSPFS 45° |
| BTM-BSF-45C-0606 | 3/8 BSPTM x 3/8 BSPFS 45° |
| BTM-BSF-45C-0808 | 1/2 BSPTM x 1/2 BSPFS 45° |
| BTM-BSF-45C-1212 | 3/4 BSPTM x 3/4 BSPFS 45° |
| BTM-BSF-45C-1616 | 1 BSPTM x 1 BSPFS 45° |
| BTM-BSF-45C-2020 | 1-1/4 BSPTM x 1-1/4 BSPFS 45° |
| BTM-BSF-45C-2424 | 1-1/2 BSPTM x 1-1/2 BSPFS 45° |

BSPT Male x BSPT Fixed Female 45 Degree

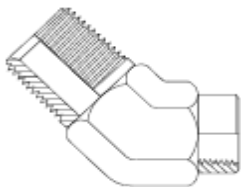

| | |
|------------------|---------------------------|
| BTM-BTF-45C-0404 | 1/4 BSPTM x 1/4 BSPTF 45° |
| BTM-BTF-45C-0606 | 3/8 BSPTM x 3/8 BSPTF 45° |
| BTM-BTF-45C-0808 | 1/2 BSPTM x 1/2 BSPTF 45° |
| BTM-BTF-45C-1212 | 3/4 BSPTM x 3/4 BSPTF 45° |
| BTM-BTF-45C-1616 | 1 BSPTM x 1 BSPTF 45° |

BSPT Male x BSPT Male 45 Degree

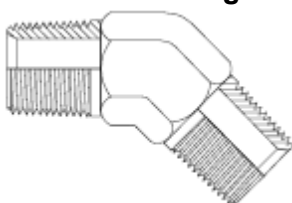

| | |
|------------------|-------------------------------|
| BTM-BTM-45C-0202 | 1/8 BSPTM x 1/8 BSPTM 45° |
| BTM-BTM-45C-0204 | 1/8 BSPTM x 1/4 BSPTM 45° |
| BTM-BTM-45C-0404 | 1/4 BSPTM x 1/4 BSPTM 45° |
| BTM-BTM-45C-0406 | 1/4 BSPTM x 3/8 BSPTM 45° |
| BTM-BTM-45C-0606 | 3/8 BSPTM x 3/8 BSPTM 45° |
| BTM-BTM-45C-0608 | 3/8 BSPTM x 1/2 BSPTM 45° |
| BTM-BTM-45C-0808 | 1/2 BSPTM x 1/2 BSPTM 45° |
| BTM-BTM-45C-0812 | 1/2 BSPTM x 3/4 BSPTM 45° |
| BTM-BTM-45C-1212 | 3/4 BSPTM x 3/4 BSPTM 45° |
| BTM-BTM-45C-1216 | 3/4 BSPTM x 1 BSPTM 45° |
| BTM-BTM-45C-1616 | 1 BSPTM x 1 BSPTM 45° |
| BTM-BTM-45C-2020 | 1-1/4 BSPTM x 1-1/4 BSPTM 45° |

BSPT Male x JIC Male 45 Degree

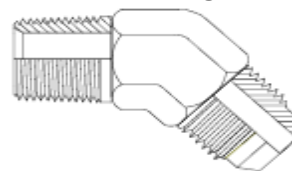

| | |
|------------------|------------------------------|
| BTM-JIM-45C-0207 | 1/8 BSPTM x 7/16 JICM 45° |
| BTM-JIM-45C-0208 | 1/8 BSPTM x 1/2 JICM 45° |
| BTM-JIM-45C-0209 | 1/8 BSPTM x 9/16 JICM 45° |
| BTM-JIM-45C-0407 | 1/4 BSPTM x 7/16 JICM 45° |
| BTM-JIM-45C-0409 | 1/4 BSPTM x 9/16 JICM 45° |
| BTM-JIM-45C-0412 | 1/4 BSPTM x 3/4 JICM 45° |
| BTM-JIM-45C-0607 | 3/8 BSPTM x 7/16 JICM 45° |
| BTM-JIM-45C-0609 | 3/8 BSPTM x 9/16 JICM 45° |
| BTM-JIM-45C-0612 | 3/8 BSPTM x 3/4 JICM 45° |
| BTM-JIM-45C-0614 | 3/8 BSPTM x 7/8 JICM 45° |
| BTM-JIM-45C-0809 | 1/2 BSPTM x 9/16 JICM 45° |
| BTM-JIM-45C-0812 | 1/2 BSPTM x 3/4 JICM 45° |
| BTM-JIM-45C-0814 | 1/2 BSPTM x 7/8 JICM 45° |
| BTM-JIM-45C-0817 | 1/2 BSPTM x 1-1/16 JICM 45° |
| BTM-JIM-45C-1212 | 3/4 BSPTM x 3/4 JICM 45° |
| BTM-JIM-45C-1214 | 3/4 BSPTM x 7/8 JICM 45° |
| BTM-JIM-45C-1217 | 3/4 BSPTM x 1-1/16 JICM 45° |
| BTM-JIM-45C-1221 | 3/4 BSPTM x 1-5/16 JICM 45° |
| BTM-JIM-45C-1621 | 1 BSPTM x 1-5/16 JICM 45° |
| BTM-JIM-45C-2026 | 1-1/4 BSPTM x 1-5/8 JICM 45° |
| BTM-JIM-45C-2430 | 1-1/2 BSPTM x 1-7/8 JICM 45° |
| BTM-JIM-45C-3240 | 2 BSPTM x 2-1/2 JICM 45° |

JIC Male x Code 61 Flange 45 Degree Swept

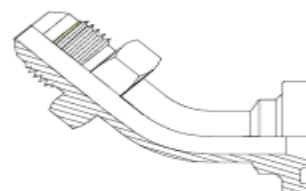

| | |
|------------------|-----------------------------------|
| JIM-F61-45S-1208 | 3/4 JICM x 1/2 C61 Flange 45 |
| JIM-F61-45S-1412 | 7/8 JICM x 3/4 C61 Flange 45 |
| JIM-F61-45S-1712 | 1-1/16 JICM x 3/4 C61 Flange 45 |
| JIM-F61-45S-1716 | 1-1/16 JICM x 1 C61 Flange 45 |
| JIM-F61-45S-2112 | 1-5/16 JICM x 3/4 C61 Flange 45 |
| JIM-F61-45S-2116 | 1-5/16 JICM x 1 C61 Flange 45 |
| JIM-F61-45S-2120 | 1-5/16 JICM x 1-1/4 C61 Flange 45 |
| JIM-F61-45S-2620 | 1-5/8 JICM x 1-1/4 C61 Flange 45 |
| JIM-F61-45S-2624 | 1-5/8 JICM x 1-1/2 C61 Flange 45 |
| JIM-F61-45S-3024 | 1-7/8 JICM x 1-1/2 C61 Flange 45 |

JIC Male x Code 62 Flange 45 Degree Swept

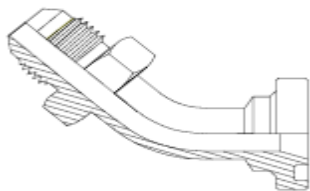

| | |
|------------------|-----------------------------------|
| JIM-F62-45S-1712 | 1-1/16 JICM x 3/4 C62 Flange 45 |
| JIM-F62-45S-1716 | 1-1/16 JICM x 1 C62 Flange 45 |
| JIM-F62-45S-2116 | 1-5/16 JICM x 1 C62 Flange 45 |
| JIM-F62-45S-2120 | 1-5/16 JICM x 1-1/4 C62 Flange 45 |
| JIM-F62-45S-2620 | 1-5/8 JICM x 1-1/4 C62 Flange 45 |
| JIM-F62-45S-3024 | 1-7/8 JICM x 1-1/2 C62 Flange 45 |

JIC Male x JIC Male 45 Degree

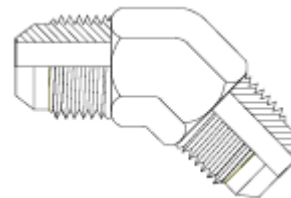

| | |
|------------------|-------------------------------|
| JIM-JIM-45C-0707 | 7/16 JICM x 7/16 JICM 45° |
| JIM-JIM-45C-0909 | 9/16 JICM x 9/16 JICM 45° |
| JIM-JIM-45C-1212 | 3/4 JICM x 3/4 JICM 45° |
| JIM-JIM-45C-1414 | 7/8 JICM x 7/8 JICM 45° |
| JIM-JIM-45C-1717 | 1-1/16 JICM x 1-1/16 JICM 45° |
| JIM-JIM-45C-2121 | 1-5/16 JICM x 1-5/16 JICM 45° |

JIC Male x JIC Female Swivel 45 Degree

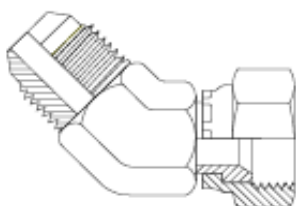

| | |
|------------------|--------------------------------|
| JIM-JIF-45C-0707 | 7/16 JICM x 7/16 JICFS 45° |
| JIM-JIF-45C-0808 | 1/2 JICM x 1/2 JICFS 45° |
| JIM-JIF-45C-0909 | 9/16 JICM x 9/16 JICFS 45° |
| JIM-JIF-45C-1212 | 3/4 JICM x 3/4 JICFS 45° |
| JIM-JIF-45C-1414 | 7/8 JICM x 7/8 JICFS 45° |
| JIM-JIF-45C-1717 | 1-1/16 JICM x 1-1/16 JICFS 45° |
| JIM-JIF-45C-2121 | 1-5/16 JICM x 1-5/16 JICFS 45° |
| JIM-JIF-45C-2626 | 1-5/8 JICM x 1-5/8 JICFS 45° |
| JIM-JIF-45C-3030 | 1-7/8 JICM x 1-7/8 JICFS 45° |
| JIM-JIF-45C-4040 | 2-1/2 JICM x 2-1/2 JICFS 45° |

JIC Male x UNO Male 45 Degree

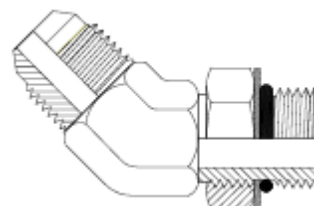

| | |
|------------------|-------------------------------|
| JIM-UNM-45C-0707 | 7/16 JICM x 7/16 UNOM 45° |
| JIM-UNM-45C-0709 | 7/16 JICM x 9/16 UNOM 45° |
| JIM-UNM-45C-0907 | 9/16 JICM x 7/16 UNOM 45° |
| JIM-UNM-45C-0909 | 9/16 JICM x 9/16 UNOM 45° |
| JIM-UNM-45C-0912 | 9/16 JICM x 3/4 UNOM 45° |
| JIM-UNM-45C-1209 | 3/4 JICM x 9/16 UNOM 45° |
| JIM-UNM-45C-1212 | 3/4 JICM x 3/4 UNOM 45° |
| JIM-UNM-45C-1214 | 3/4 JICM x 7/8 UNOM 45° |
| JIM-UNM-45C-1217 | 3/4 JICM x 1-1/16 UNOM 45° |
| JIM-UNM-45C-1412 | 7/8 JICM x 3/4 UNOM 45° |
| JIM-UNM-45C-1414 | 7/8 JICM x 7/8 UNOM 45° |
| JIM-UNM-45C-1417 | 7/8 JICM x 1-1/16 UNOM 45° |
| JIM-UNM-45C-1714 | 1-1/16 JICM x 7/8 UNOM 45° |
| JIM-UNM-45C-1717 | 1-1/16 JICM x 1-1/16 UNOM 45° |
| JIM-UNM-45C-1721 | 1-1/16 JICM x 1-5/16 UNOM 45° |
| JIM-UNM-45C-2117 | 1-5/16 JICM x 1-1/16 UNOM 45° |
| JIM-UNM-45C-2121 | 1-5/16 JICM x 1-5/16 UNOM 45° |
| JIM-UNM-45C-2126 | 1-5/16 JICM x 1-5/8 UNOM 45° |
| JIM-UNM-45C-2626 | 1-5/8 JICM x 1-5/8 UNOM 45° |
| JIM-UNM-45C-2630 | 1-5/8 JICM x 1-7/8 UNOM 45° |
| JIM-UNM-45C-3030 | 1-7/8 JICM x 1-7/8 UNOM 45° |

NPT Male x JIC Male 45 Degree

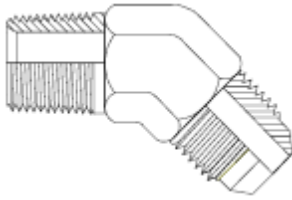

| | |
|------------------|------------------------------|
| NTM-JIM-45C-0207 | 1/8 NPTM x 7/16 JICM 45° |
| NTM-JIM-45C-0208 | 1/8 NPTM x 1/2 JICM 45° |
| NTM-JIM-45C-0209 | 1/8 NPTM x 9/16 JICM 45° |
| NTM-JIM-45C-0407 | 1/4 NPTM x 7/16 JICM 45° |
| NTM-JIM-45C-0408 | 1/4 NPTM x 1/2 JICM 45° |
| NTM-JIM-45C-0409 | 1/4 NPTM x 9/16 JICM 45° |
| NTM-JIM-45C-0412 | 1/4 NPTM x 3/4 JICM 45° |
| NTM-JIM-45C-0607 | 3/8 NPTM x 7/16 JICM 45° |
| NTM-JIM-45C-0609 | 3/8 NPTM x 9/16 JICM 45° |
| NTM-JIM-45C-0612 | 3/8 NPTM x 3/4 JICM 45° |
| NTM-JIM-45C-0614 | 3/8 NPTM x 7/8 JICM 45° |
| NTM-JIM-45C-0809 | 1/2 NPTM x 9/16 JICM 45° |
| NTM-JIM-45C-0812 | 1/2 NPTM x 3/4 JICM 45° |
| NTM-JIM-45C-0814 | 1/2 NPTM x 7/8 JICM 45° |
| NTM-JIM-45C-0817 | 1/2 NPTM x 1-1/16 JICM 45° |
| NTM-JIM-45C-1212 | 3/4 NPTM x 3/4 JICM 45° |
| NTM-JIM-45C-1217 | 3/4 NPTM x 1-1/16 JICM 45° |
| NTM-JIM-45C-1617 | 1 NPTM x 1-1/16 JICM 45° |
| NTM-JIM-45C-1621 | 1 NPTM x 1-5/16 JICM 45° |
| NTM-JIM-45C-1626 | 1 NPTM x 1-5/8 JICM 45° |
| NTM-JIM-45C-2021 | 1-1/4 NPTM x 1-5/16 JICM 45° |
| NTM-JIM-45C-2026 | 1-1/4 NPTM x 1-5/8 JICM 45° |
| NTM-JIM-45C-2430 | 1-1/2 NPTM x 1-7/8 JICM 45° |
| NTM-JIM-45C-3240 | 2 NPTM x 2-1/2 JICM 45° |

NPT Female x NPT Female Swivel 45 Degree

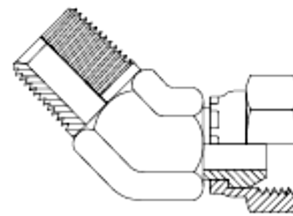

| | |
|------------------|------------------------------|
| NTM-NSF-45C-0202 | 1/8 NPTM x 1/8 NPTSF 45° |
| NTM-NSF-45C-0404 | 1/4 NPTM x 1/4 NPTSF 45° |
| NTM-NSF-45C-0606 | 3/8 NPTM x 3/8 NPTSF 45° |
| NTM-NSF-45C-0808 | 1/2 NPTM x 1/2 NPTSF 45° |
| NTM-NSF-45C-1212 | 3/4 NPTM x 3/4 NPTSF 45° |
| NTM-NSF-45C-2424 | 1-1/2 NPTM x 1-1/2 NPTSF 45° |

NPT Male x NPT Fixed Female 45 Degree

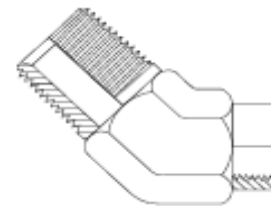

| | |
|------------------|-----------------------------|
| NTM-NTF-45C-0202 | 1/8 NPTM x 1/8 NPTF 45° |
| NTM-NTF-45C-0404 | 1/4 NPTM x 1/4 NPTF 45° |
| NTM-NTF-45C-0606 | 3/8 NPTM x 3/8 NPTF 45° |
| NTM-NTF-45C-0808 | 1/2 NPTM x 1/2 NPTF 45° |
| NTM-NTF-45C-1212 | 3/4 NPTM x 3/4 NPTF 45° |
| NTM-NTF-45C-1616 | 1 NPTM x 1 NPTF 45° |
| NTM-NTF-45C-2020 | 1-1/4 NPTM x 1-1/4 NPTF 45° |

NPT Male x NPT Male 45 Degree

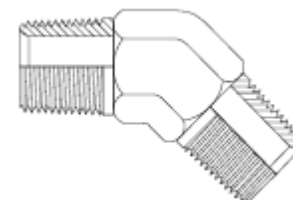

| | |
|------------------|-------------------------|
| NTM-NTM-45C-0808 | 1/2 NPTM x 1/2 NPTM 45° |
| NTM-NTM-45C-1616 | 1 NPTM x 1 NPTM 45° |

ORFS Male x ORFS Female Swivel 45 Degree

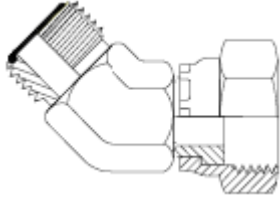

| | |
|------------------|-----------------------------------|
| ORM-ORF-45C-0909 | 9/16 ORFSM x 9/16 ORFSF 45° |
| ORM-ORF-45C-1109 | 11/16 ORFSM x 9/16 ORFSF 45° |
| ORM-ORF-45C-1111 | 11/16 ORFSM x 11/16 ORFSF 45° |
| ORM-ORF-45C-1313 | 13/16 ORFSM x 13/16 ORFSF 45° |
| ORM-ORF-45C-1616 | 1 ORFSM x 1 ORFSF 45° |
| ORM-ORF-45C-1919 | 1-3/16 ORFSM x 1-3/16 ORFSF 45° |
| ORM-ORF-45C-2323 | 1-7/16 ORFSM x 1-7/16 ORFSF 45° |
| ORM-ORF-45C-2727 | 1-11/16 ORFSM x 1-11/16 ORFSF 45° |

ORFS Male x UNO Male 45 Degree

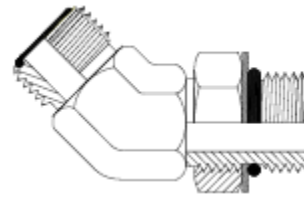

| | |
|------------------|--------------------------------|
| ORM-UNM-45C-0907 | 9/16 ORFSM x 7/16 UNOM 45° |
| ORM-UNM-45C-0909 | 9/16 ORFSM x 9/16 UNOM 45° |
| ORM-UNM-45C-1107 | 11/16 ORFSM x 7/16 UNOM 45° |
| ORM-UNM-45C-1109 | 11/16 ORFSM x 9/16 UNOM 45° |
| ORM-UNM-45C-1112 | 11/16 ORFSM x 3/4 UNOM 45° |
| ORM-UNM-45C-1114 | 11/16 ORFSM x 7/8 UNOM 45° |
| ORM-UNM-45C-1312 | 13/16 ORFSM x 3/4 UNOM 45° |
| ORM-UNM-45C-1314 | 13/16 ORFSM x 7/8 UNOM 45° |
| ORM-UNM-45C-1614 | 1 ORFSM x 7/8 UNOM 45° |
| ORM-UNM-45C-1917 | 1-3/16 ORFSM x 1-1/16 UNOM 45° |
| ORM-UNM-45C-1921 | 1-3/16 ORFSM x 1-5/16 UNOM 45° |
| ORM-UNM-45C-2317 | 1-7/16 ORFSM x 1-1/16 UNOM 45° |
| ORM-UNM-45C-2321 | 1-7/16 ORFSM x 1-5/16 UNOM 45° |
| ORM-UNM-45C-2726 | 1-11/16 ORFSM x 1-5/8 UNOM 45° |

90 Degree Adaptors

BSPP Male x BSPP Male 90 Degree

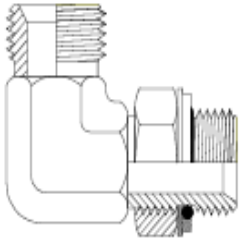

| | |
|------------------|-------------------------------|
| BPM-BPM-90C-0404 | 1/4 BSPPM x 1/4 BSPPM 90° |
| BPM-BPM-90C-0406 | 1/4 BSPPM x 3/8 BSPPM 90° |
| BPM-BPM-90C-0606 | 3/8 BSPPM x 3/8 BSPPM 90° |
| BPM-BPM-90C-0608 | 3/8 BSPPM x 1/2 BSPPM 90° |
| BPM-BPM-90C-0808 | 1/2 BSPPM x 1/2 BSPPM 90° |
| BPM-BPM-90C-1212 | 3/4 BSPPM x 3/4 BSPPM 90° |
| BPM-BPM-90C-1616 | 1 BSPPM x 1 BSPPM 90° |
| BPM-BPM-90C-2020 | 1-1/4 BSPPM x 1-1/4 BSPPM 90° |

BSPP Male x BSPT Male 90 Degree

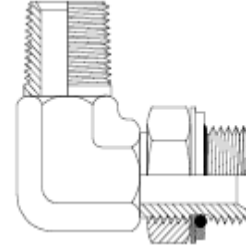

| | |
|------------------|-------------------------------|
| BPM-BTM-90C-0404 | 1/4 BSPPM x 1/4 BSPTM 90° |
| BPM-BTM-90C-0604 | 3/8 BSPPM x 1/4 BSPTM 90° |
| BPM-BTM-90C-0606 | 3/8 BSPPM x 3/8 BSPTM 90° |
| BPM-BTM-90C-0608 | 3/8 BSPPM x 1/2 BSPTM 90° |
| BPM-BTM-90C-0806 | 1/2 BSPPM x 3/8 BSPTM 90° |
| BPM-BTM-90C-0808 | 1/2 BSPPM x 1/2 BSPTM 90° |
| BPM-BTM-90C-0812 | 1/2 BSPPM x 3/4 BSPTM 90° |
| BPM-BTM-90C-1208 | 3/4 BSPPM x 1/2 BSPTM 90° |
| BPM-BTM-90C-1212 | 3/4 BSPPM x 3/4 BSPTM 90° |
| BPM-BTM-90C-1216 | 3/4 BSPPM x 1 BSPTM 90° |
| BPM-BTM-90C-1612 | 1 BSPPM x 3/4 BSPTM 90° |
| BPM-BTM-90C-1616 | 1 BSPPM x 1 BSPTM 90° |
| BPM-BTM-90C-2020 | 1-1/4 BSPPM x 1-1/4 BSPTM 90° |
| BPM-BTM-90C-2424 | 1-1/2 BSPPM x 1-1/2 BSPTM 90° |

BSPP Male x BSPP Female Swivel 90 Degree

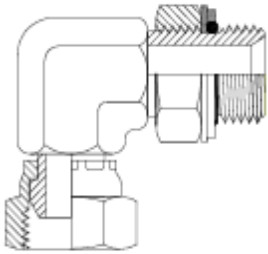

| | |
|------------------|-------------------------------|
| BPM-BSF-90C-0202 | 1/8 BSPPM x 1/8 BSPFS 90° |
| BPM-BSF-90C-0404 | 1/4 BSPPM x 1/4 BSPFS 90° |
| BPM-BSF-90C-0606 | 3/8 BSPPM x 3/8 BSPFS 90° |
| BPM-BSF-90C-0808 | 1/2 BSPPM x 1/2 BSPFS 90° |
| BPM-BSF-90C-1212 | 3/4 BSPPM x 3/4 BSPFS 90° |
| BPM-BSF-90C-1616 | 1 BSPPM x 1 BSPFS 90° |
| BPM-BSF-90C-2020 | 1-1/4 BSPPM x 1-1/4 BSPFS 90° |

BSPP Male x JIC Male 90 Degree

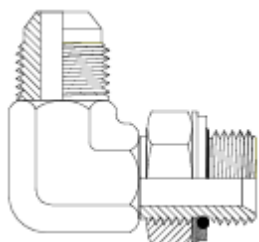

| | |
|------------------|-------------------------------|
| BPM-JIM-90C-0207 | 1/8 BSPPM x 7/16 JICM 90° |
| BPM-JIM-90C-0209 | 1/8 BSPPM x 9/16 JICM 90° |
| BPM-JIM-90C-0407 | 1/4 BSPPM x 7/16 JICM 90° |
| BPM-JIM-90C-0408 | 1/4 BSPPM x 1/2 JICM 90° |
| BPM-JIM-90C-0409 | 1/4 BSPPM x 9/16 JICM 90° |
| BPM-JIM-90C-0412 | 1/4 BSPPM x 3/4 JICM 90° |
| BPM-JIM-90C-0607 | 3/8 BSPPM x 7/16 JICM 90° |
| BPM-JIM-90C-0609 | 3/8 BSPPM x 9/16 JICM 90° |
| BPM-JIM-90C-0612 | 3/8 BSPPM x 3/4 JICM 90° |
| BPM-JIM-90C-0614 | 3/8 BSPPM x 7/8 JICM 90° |
| BPM-JIM-90C-0807 | 1/2 BSPPM x 7/16 JICM 90° |
| BPM-JIM-90C-0809 | 1/2 BSPPM x 9/16 JICM 90° |
| BPM-JIM-90C-0812 | 1/2 BSPPM x 3/4 JICM 90° |
| BPM-JIM-90C-0814 | 1/2 BSPPM x 7/8 JICM 90° |
| BPM-JIM-90C-0817 | 1/2 BSPPM x 1-1/16 JICM 90° |
| BPM-JIM-90C-1212 | 3/4 BSPPM x 3/4 JICM 90° |
| BPM-JIM-90C-1214 | 3/4 BSPPM x 7/8 JICM 90° |
| BPM-JIM-90C-1217 | 3/4 BSPPM x 1-1/16 JICM 90° |
| BPM-JIM-90C-1221 | 3/4 BSPPM x 1-5/16 JICM 90° |
| BPM-JIM-90C-1617 | 1 BSPPM x 1-1/16 JICM 90° |
| BPM-JIM-90C-1621 | 1 BSPPM x 1-5/16 JICM 90° |
| BPM-JIM-90C-1626 | 1 BSPPM x 1-5/8 JICM 90° |
| BPM-JIM-90C-2017 | 1-1/4 BSPPM x 1-1/16 JICM 90° |
| BPM-JIM-90C-2021 | 1-1/4 BSPPM x 1-5/16 JICM 90° |
| BPM-JIM-90C-2026 | 1-1/4 BSPPM x 1-5/8 JICM 90° |
| BPM-JIM-90C-2030 | 1-1/4 BSPPM x 1-7/8 JICM 90° |
| BPM-JIM-90C-2426 | 1-1/2 BSPPM x 1-5/8 JICM 90° |
| BPM-JIM-90C-2430 | 1-1/2 BSPPM x 1-7/8 JICM 90° |
| BPM-JIM-90C-3240 | 2 BSPPM x 2-1/2 JICM 90° |

BSPP Male x ORFS Male 90 Degree

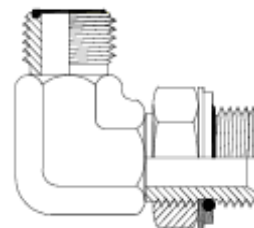

| | |
|------------------|------------------------------|
| BPM-ORM-90C-0209 | 1/8 BSPPM x 9/16 ORFSM 90° |
| BPM-ORM-90C-0409 | 1/4 BSPPM x 9/16 ORFSM 90° |
| BPM-ORM-90C-0411 | 1/4 BSPPM x 11/16 ORFSM 90° |
| BPM-ORM-90C-0413 | 1/4 BSPPM x 13/16 ORFSM 90° |
| BPM-ORM-90C-0609 | 3/8 BSPPM x 9/16 ORFSM 90° |
| BPM-ORM-90C-0611 | 3/8 BSPPM x 11/16 ORFSM 90° |
| BPM-ORM-90C-0613 | 3/8 BSPPM x 13/16 ORFSM 90° |
| BPM-ORM-90C-0811 | 1/2 BSPPM x 11/16 ORFSM 90° |
| BPM-ORM-90C-0813 | 1/2 BSPPM x 13/16 ORFSM 90° |
| BPM-ORM-90C-0816 | 1/2 BSPPM x 1 ORFSM 90° |
| BPM-ORM-90C-0819 | 1/2 BSPPM x 1-3/16 ORFSM 90° |
| BPM-ORM-90C-1213 | 3/4 BSPPM x 13/16 ORFSM 90° |
| BPM-ORM-90C-1216 | 3/4 BSPPM x 1 ORFSM 90° |
| BPM-ORM-90C-1219 | 3/4 BSPPM x 1-3/16 ORFSM 90° |
| BPM-ORM-90C-1223 | 3/4 BSPPM x 1-7/16 ORFSM 90° |
| BPM-ORM-90C-1619 | 1 BSPPM x 1-3/16 ORFSM 90° |
| BPM-ORM-90C-1623 | 1 BSPPM x 1-7/16 ORFSM 90° |

BSPP Female Swivel x UNO Male 90 Degree

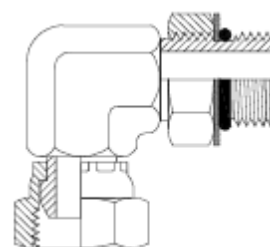

| | |
|------------------|-----------------------------|
| BSF-UNM-90C-0609 | 3/8 BSPFS x 9/16 UNOM 90° |
| BSF-UNM-90C-0612 | 3/8 BSPFS x 3/4 UNOM 90° |
| BSF-UNM-90C-0812 | 1/2 BSPFS x 3/4 UNOM 90° |
| BSF-UNM-90C-0814 | 1/2 BSPFS x 7/8 UNOM 90° |
| BSF-UNM-90C-1217 | 3/4 BSPFS x 1-1/16 UNOM 90° |

BSPT Female x BSPT Female Fixed 90 Degree

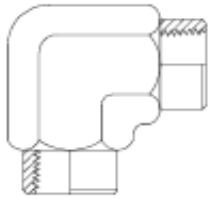

| | |
|------------------|-------------------------------|
| BTF-BTF-90C-0202 | 1/8 BSPTF x 1/8 BSPTF 90° |
| BTF-BTF-90C-0204 | 1/8 BSPTF X 1/4 BSPTF 90° |
| BTF-BTF-90C-0404 | 1/4 BSPTF x 1/4 BSPTF 90° |
| BTF-BTF-90C-0606 | 3/8 BSPTF x 3/8 BSPTF 90° |
| BTF-BTF-90C-0608 | 3/8 BSPTF x 1/2 BSPTF 90° |
| BTF-BTF-90C-0808 | 1/2 BSPTF x 1/2 BSPTF 90° |
| BTF-BTF-90C-1212 | 3/4 BSPTF x 3/4 BSPTF 90° |
| BTF-BTF-90C-1616 | 1 BSPTF x 1 BSPTF 90° |
| BTF-BTF-90C-2020 | 1-1/4 BSPTF x 1-1/4 BSPTF 90° |
| BTF-BTF-90C-2424 | 1-1/2 BSPTF X 1-1/2 BSPTF 90° |
| BTF-BTF-90C-3232 | 2 BSPTF X 2 BSPTF 90° |

BSPT Fixed Female x JIC Male 90 Degree

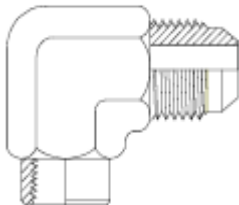

| | |
|------------------|-----------------------------|
| BTF-JIM-90C-0409 | 1/4 BSPTF x 9/16 JICM 90° |
| BTF-JIM-90C-0812 | 1/2 BSPTF x 3/4 JICM 90° |
| BTF-JIM-90C-1217 | 3/4 BSPTF x 1-1/16 JICM 90° |

BSPT Male x BSPP Female Swivel 90 Degree

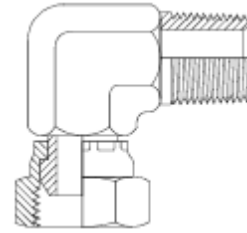

| | |
|------------------|-------------------------------|
| BTM-BSF-90C-0202 | 1/8 BSPTM x 1/8 BSPFS 90° |
| BTM-BSF-90C-0404 | 1/4 BSPTM x 1/4 BSPFS 90° |
| BTM-BSF-90C-0406 | 1/4 BSPTM x 3/8 BSPFS 90° |
| BTM-BSF-90C-0604 | 3/8 BSPTM x 1/4 BSPFS 90° |
| BTM-BSF-90C-0606 | 3/8 BSPTM x 3/8 BSPFS 90° |
| BTM-BSF-90C-0608 | 3/8 BSPTM x 1/2 BSPFS 90° |
| BTM-BSF-90C-0806 | 1/2 BSPTM x 3/8 BSPFS 90° |
| BTM-BSF-90C-0808 | 1/2 BSPTM x 1/2 BSPFS 90° |
| BTM-BSF-90C-0812 | 1/2 BSPTM X 3/4 BSPFS 90° |
| BTM-BSF-90C-1208 | 3/4 BSPTM x 1/2 BSPFS 90° |
| BTM-BSF-90C-1212 | 3/4 BSPTM x 3/4 BSPFS 90° |
| BTM-BSF-90C-1216 | 3/4 BSPTM x 1 BSPFS 90° |
| BTM-BSF-90C-1616 | 1 BSPTM x 1 BSPFS 90° |
| BTM-BSF-90C-2020 | 1-1/4 BSPTM x 1-1/4 BSPFS 90° |
| BTM-BSF-90C-2424 | 1-1/2 BSPTM x 1-1/2 BSPFS 90° |
| BTM-BSF-90C-3232 | 2 BSPTM x 2 BSPFS 90° |

BSPT Male x BSPT Fixed Female 90 Degree

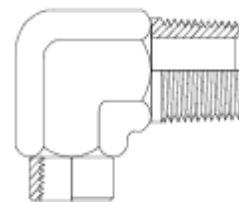

| | |
|------------------|-------------------------------|
| BTM-BTF-90C-0202 | 1/8 BSPTM x 1/8 BSPTF 90° |
| BTM-BTF-90C-0404 | 1/4 BSPTM x 1/4 BSPTF 90° |
| BTM-BTF-90C-0606 | 3/8 BSPTM x 3/8 BSPTF 90° |
| BTM-BTF-90C-0608 | 3/8 BSPTM x 1/2 BSPTF 90° |
| BTM-BTF-90C-0806 | 1/2 BSPTM x 3/8 BSPTF 90° |
| BTM-BTF-90C-0808 | 1/2 BSPTM x 1/2 BSPTF 90° |
| BTM-BTF-90C-1208 | 3/4 BSPTM x 1/2 BSPTF 90° |
| BTM-BTF-90C-1212 | 3/4 BSPTM x 3/4 BSPTF 90° |
| BTM-BTF-90C-1616 | 1 BSPTM x 1 BSPTF 90° |
| BTM-BTF-90C-2020 | 1-1/4 BSPTM x 1-1/4 BSPTF 90° |
| BTM-BTF-90C-2424 | 1-1/2 BSPTM x 1-1/2 BSPTF 90° |
| BTM-BTF-90C-3232 | 2 BSPTM x 2 BSPTF 90° |

BSPT Male x BSPT Male 90 Degree

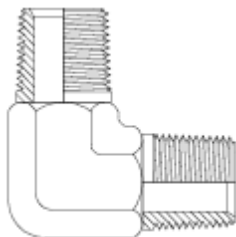

BSPT Male x JIC Male 90 Degree

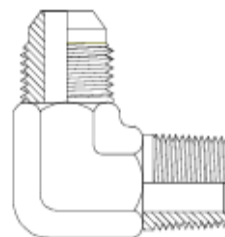

| | |
|------------------|-------------------------------|
| BTM-BTM-90C-0202 | 1/8 BSPTM x 1/8 BSPTM 90° |
| BTM-BTM-90C-0204 | 1/8 BSPTM x 1/4 BSPTM 90° |
| BTM-BTM-90C-0404 | 1/4 BSPTM x 1/4 BSPTM 90° |
| BTM-BTM-90C-0406 | 1/4 BSPTM x 3/8 BSPTM 90° |
| BTM-BTM-90C-0408 | 1/4 BSPTM x 1/2 BSPTM 90° |
| BTM-BTM-90C-0606 | 3/8 BSPTM x 3/8 BSPTM 90° |
| BTM-BTM-90C-0608 | 3/8 BSPTM x 1/2 BSPTM 90° |
| BTM-BTM-90C-0808 | 1/2 BSPTM x 1/2 BSPTM 90° |
| BTM-BTM-90C-0812 | 1/2 BSPTM x 3/4 BSPTM 90° |
| BTM-BTM-90C-1212 | 3/4 BSPTM x 3/4 BSPTM 90° |
| BTM-BTM-90C-1216 | 3/4 BSPTM x 1 BSPTM 90° |
| BTM-BTM-90C-1616 | 1 BSPTM x 1 BSPTM 90° |
| BTM-BTM-90C-1620 | 1 BSPTM x 1-1/4 BSPTM 90° |
| BTM-BTM-90C-2020 | 1-1/4 BSPTM x 1-1/4 BSPTM 90° |
| BTM-BTM-90C-2424 | 1-1/2 BSPTM x 1-1/2 BSPTM 90° |
| BTM-BTM-90C-3232 | 2 BSPTM x 2 BSPTM 90° |

| | |
|------------------|-------------------------------|
| BTM-JIM-90C-0207 | 1/8 BSPTM x 7/16 JICM 90° |
| BTM-JIM-90C-0208 | 1/8 BSPTM x 1/2 JICM 90° |
| BTM-JIM-90C-0209 | 1/8 BSPTM x 9/16 JICM 90° |
| BTM-JIM-90C-0407 | 1/4 BSPTM x 7/16 JICM 90° |
| BTM-JIM-90C-0408 | 1/4 BSPTM x 1/2 JICM 90° |
| BTM-JIM-90C-0409 | 1/4 BSPTM x 9/16 JICM 90° |
| BTM-JIM-90C-0412 | 1/4 BSPTM x 3/4 JICM 90° |
| BTM-JIM-90C-0607 | 3/8 BSPTM x 7/16 JICM 90° |
| BTM-JIM-90C-0609 | 3/8 BSPTM x 9/16 JICM 90° |
| BTM-JIM-90C-0612 | 3/8 BSPTM x 3/4 JICM 90° |
| BTM-JIM-90C-0614 | 3/8 BSPTM x 7/8 JICM 90° |
| BTM-JIM-90C-0807 | 1/2 BSPTM x 7/16 JICM 90° |
| BTM-JIM-90C-0809 | 1/2 BSPTM x 9/16 JICM 90° |
| BTM-JIM-90C-0812 | 1/2 BSPTM x 3/4 JICM 90° |
| BTM-JIM-90C-0814 | 1/2 BSPTM x 7/8 JICM 90° |
| BTM-JIM-90C-0817 | 1/2 BSPTM x 1-1/16 JICM 90° |
| BTM-JIM-90C-1209 | 3/4 BSPTM x 9/16 JICM 90° |
| BTM-JIM-90C-1212 | 3/4 BSPTM x 3/4 JICM 90° |
| BTM-JIM-90C-1214 | 3/4 BSPTM x 7/8 JICM 90° |
| BTM-JIM-90C-1217 | 3/4 BSPTM x 1-1/16 JICM 90° |
| BTM-JIM-90C-1221 | 3/4 BSPTM x 1-5/16 JICM 90° |
| BTM-JIM-90C-1614 | 1 BSPTM x 7/8 JICM 90° |
| BTM-JIM-90C-1617 | 1 BSPTM x 1-1/16 JICM 90° |
| BTM-JIM-90C-1621 | 1 BSPTM x 1-5/16 JICM 90° |
| BTM-JIM-90C-1626 | 1 BSPTM x 1-5/8 JICM 90° |
| BTM-JIM-90C-2017 | 1-1/4 BSPTM x 1-1/16 JICM 90° |
| BTM-JIM-90C-2021 | 1-1/4 BSPTM x 1-5/16 JICM 90° |
| BTM-JIM-90C-2026 | 1-1/4 BSPTM x 1-5/8 JICM 90° |
| BTM-JIM-90C-2030 | 1-1/4 BSPTM x 1-7/8 JICM 90° |
| BTM-JIM-90C-2426 | 1-1/2 BSPTM x 1-5/8 JICM 90° |
| BTM-JIM-90C-2430 | 1-1/2 BSPTM x 1-7/8 JICM 90° |
| BTM-JIM-90C-2440 | 1-1/2 BSPTM x 2-1/2 JICM 90° |
| BTM-JIM-90C-3240 | 2 BSPTM x 2-1/2 JICM 90° |

BSPT Male x JIC Female Swivel 90 Degree

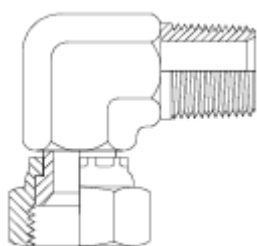

| | |
|------------------|------------------------------|
| BTM-JIF-90C-0407 | 1/4 BSPTM x 7/16 JICFS 90° |
| BTM-JIF-90C-0409 | 1/4 BSPTM x 9/16 JICFS 90° |
| BTM-JIF-90C-0609 | 3/8 BSPTM x 9/16 JICFS 90° |
| BTM-JIF-90C-0612 | 3/8 BSPTM x 3/4 JICFS 90° |
| BTM-JIF-90C-0614 | 3/8 BSPTM x 7/8 JICFS 90° |
| BTM-JIF-90C-0812 | 1/2 BSPTM x 3/4 JICFS 90° |
| BTM-JIF-90C-0814 | 1/2 BSPTM x 7/8 JICFS 90° |
| BTM-JIF-90C-1217 | 3/4 BSPTM x 1-1/16 JICFS 90° |
| BTM-JIF-90C-1621 | 1 BSPTM x 1-5/16 JICFS 90° |

BSPT Male x UNO Male 90 Degree

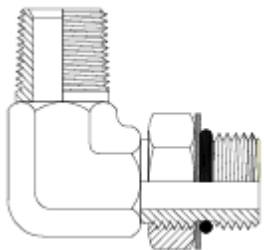

| | |
|------------------|-----------------------------|
| BTM-UNM-90C-0407 | 1/4 BSPTM x 7/16 UNOM 90° |
| BTM-UNM-90C-0409 | 1/4 BSPTM x 9/16 UNOM 90° |
| BTM-UNM-90C-0412 | 1/4 BSPTM x 3/4 UNOM 90° |
| BTM-UNM-90C-0609 | 3/8 BSPTM x 9/16 UNOM 90° |
| BTM-UNM-90C-0612 | 3/8 BSPTM x 3/4 UNOM 90° |
| BTM-UNM-90C-0614 | 3/8 BSPTM x 7/8 UNOM 90° |
| BTM-UNM-90C-0812 | 1/2 BSPTM x 3/4 UNOM 90° |
| BTM-UNM-90C-0814 | 1/2 BSPTM x 7/8 UNOM 90° |
| BTM-UNM-90C-0817 | 1/2 BSPTM x 1-1/16 UNOM 90° |
| BTM-UNM-90C-1214 | 3/4 BSPTM x 7/8 UNOM 90° |
| BTM-UNM-90C-1217 | 3/4 BSPTM x 1-1/16 UNOM 90° |
| BTM-UNM-90C-1617 | 1 BSPTM x 1-1/16 UNOM 90° |
| BTM-UNM-90C-1621 | 1 BSPTM x 1-5/16 UNOM 90° |
| BTM-UNM-90C-1626 | 1 BSPTM x 1-5/8 UNOM 90° |

JIC Male x Code 61 Flange 90 Degree Swept

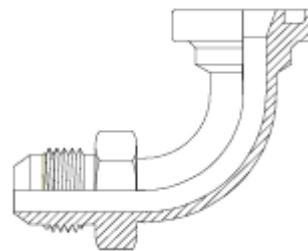

| | |
|------------------|------------------------------------|
| JIM-F61-90S-1208 | 3/4 JICM x 1/2 C61 Flange 90° |
| JIM-F61-90S-1212 | 3/4 JICM x 3/4 C61 Flange 90° |
| JIM-F61-90S-1712 | 1-1/16 JICM x 3/4 C61 Flange 90° |
| JIM-F61-90S-1716 | 1-1/16 JICM x 1 C61 Flange 90° |
| JIM-F61-90S-2112 | 1-5/16 JICM x 3/4 C61 Flange 90° |
| JIM-F61-90S-2116 | 1-5/16 JICM x 1 C61 Flange 90° |
| JIM-F61-90S-2120 | 1-5/16 JICM x 1-1/4 C61 Flange 90° |
| JIM-F61-90S-2616 | 1-5/8 JICM x 1 C61 Flange 90° |
| JIM-F61-90S-2620 | 1-5/8 JICM x 1-1/4 C61 Flange 90° |
| JIM-F61-90S-2624 | 1-5/8 JICM x 1-1/2 C61 Flange 90° |
| JIM-F61-90S-3020 | 1-7/8 JICM x 1-1/4 C61 Flange 90° |
| JIM-F61-90S-3024 | 1-7/8 JICM x 1-1/2 C61 Flange 90° |
| JIM-F61-90S-4032 | 2-1/2 JICM x 2 C61 Flange 90° |

JIC Female Swivel x UNO Male 90 Degree

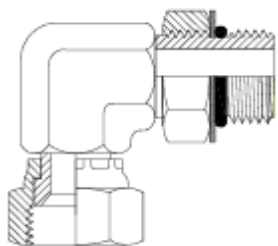

| | |
|------------------|--------------------------------|
| JIF-UNM-90C-0707 | 7/16 JICFS x 7/16 UNOM 90° |
| JIF-UNM-90C-0909 | 9/16 JICFS x 9/16 UNOM 90° |
| JIF-UNM-90C-1212 | 3/4 JICFS x 3/4 UNOM 90° |
| JIF-UNM-90C-1214 | 3/4 JICFS x 7/8 UNOM 90° |
| JIF-UNM-90C-1414 | 7/8 JICFS x 7/8 UNOM 90° |
| JIF-UNM-90C-1717 | 1-1/16 JICFS x 1-1/16 UNOM 90° |
| JIF-UNM-90C-2121 | 1-5/16 JICFS x 1-5/16 UNOM 90° |

JIC Male x Code 62 Flange 90 Degree Swept

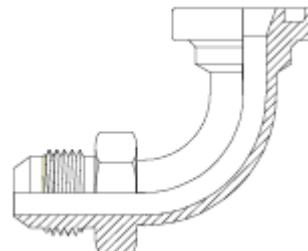

| | |
|------------------|------------------------------------|
| JIM-F62-90S-1208 | 3/4 JICM x 1/2 C62 Flange 90° |
| JIM-F62-90S-1712 | 1-1/16 JICM x 3/4 C62 Flange 90° |
| JIM-F62-90S-1716 | 1-1/16 JICM x 1 C62 Flange 90° |
| JIM-F62-90S-1720 | 1-1/16 JICM x 1-1/4 C62 Flange 90° |
| JIM-F62-90S-2112 | 1-5/16 JICM x 3/4 C62 Flange 90° |
| JIM-F62-90S-2116 | 1-5/16 JICM x 1 C62 Flange 90° |
| JIM-F62-90S-2120 | 1-5/16 JICM x 1-1/4 C62 Flange 90° |
| JIM-F62-90S-2616 | 1-5/8 JICM x 1 C62 Flange 90° |
| JIM-F62-90S-2620 | 1-5/8 JICM x 1-1/4 C62 Flange 90° |
| JIM-F62-90S-2624 | 1-5/8 JICM x 1-1/2 C62 Flange 90° |
| JIM-F62-90S-3020 | 1-7/8 JICM x 1-1/4 C62 Flange 90° |
| JIM-F62-90S-3024 | 1-7/8 JICM x 1-1/2 C62 Flange 90° |

JIC Male x JIC Female Swivel 90 Degree

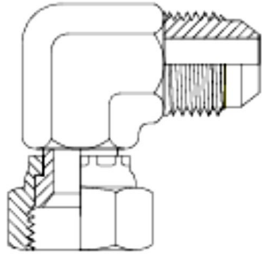

JIC Male x JIC Female Swivel 90° Swept

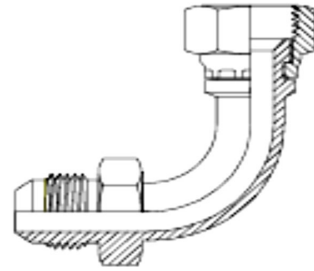

| | |
|------------------|--------------------------------|
| JIM-JIF-90C-0707 | 7/16 JICM x 7/16 JICFS 90° |
| JIM-JIF-90C-0808 | 1/2 JICM x 1/2 JICFS 90° |
| JIM-JIF-90C-0909 | 9/16 JICM x 9/16 JICFS 90° |
| JIM-JIF-90C-1209 | 3/4 JICM x 9/16 JICFS 90° |
| JIM-JIF-90C-1212 | 3/4 JICM x 3/4 JICFS 90° |
| JIM-JIF-90C-1214 | 3/4 JICM x 7/8 JICFS 90° |
| JIM-JIF-90C-1217 | 3/4 JICM x 1-1/16 JICFS 90° |
| JIM-JIF-90C-1412 | 7/8 JICM x 3/4 JICFS 90° |
| JIM-JIF-90C-1414 | 7/8 JICM x 7/8 JICFS 90° |
| JIM-JIF-90C-1417 | 7/8 JICM x 1-1/16 JICFS 90° |
| JIM-JIF-90C-1712 | 1-1/16 JICM x 3/4 JICFS 90° |
| JIM-JIF-90C-1714 | 1-1/16 JICM x 7/8 JICFS 90° |
| JIM-JIF-90C-1717 | 1-1/16 JICM x 1-1/16 JICFS 90° |
| JIM-JIF-90C-1721 | 1-1/16 JICM x 1-5/16 JICFS 90° |
| JIM-JIF-90C-2121 | 1-5/16 JICM x 1-5/16 JICFS 90° |
| JIM-JIF-90C-2626 | 1-5/8 JICM x 1-5/8 JICFS 90° |
| JIM-JIF-90C-3030 | 1-7/8 JICM x 1-7/8 JICFS 90° |
| JIM-JIF-90C-4040 | 2-1/2 JICM x 2-1/2 JICFS 90° |

| | |
|-------------------|-------------------------------------|
| JIM-JIF-90S-0707 | 7/16 JICM x 7/16 JICFS 90 Swept |
| JIM-JIF-90S-0707E | 7/16 JICM x 7/16 JICFS 90 Long |
| JIM-JIF-90S-0909 | 9/16 JICM x 9/16 JICFS 90 Swept |
| JIM-JIF-90S-0909E | 9/16 JICM x 9/16 JICFS 90 Long |
| JIM-JIF-90S-1212 | 3/4 JICM x 3/4 JICFS 90 Swept |
| JIM-JIF-90S-1212E | 3/4 JICM x 3/4 JICFS 90 Long |
| JIM-JIF-90S-1414 | 7/8 JICM x 7/8 JICFS 90 Swept |
| JIM-JIF-90S-1414E | 7/8 JICM x 7/8 JICFS 90 Long |
| JIM-JIF-90S-1717 | 1-1/16 JICM x 1-1/16 JICFS 90 Swept |
| JIM-JIF-90S-1717E | 1-1/16 JICM x 1-1/16 JICFS 90 Long |
| JIM-JIF-90S-2121 | 1-5/16 JICM x 1-5/16 JICFS 90 Swept |
| JIM-JIF-90S-2121E | 1-5/16 JICM x 1-5/16 JICFS 90 Long |
| JIM-JIF-90S-2626 | 1-5/8 JICM x 1-5/8 JICFS 90 Swept |
| JIM-JIF-90S-2626E | 1-5/8 JICM x 1-5/8 JICFS 90 Long |

JIC Male x JIC Male 90 Degree

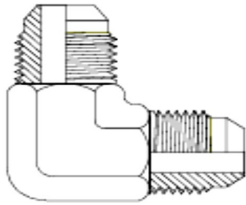

| | |
|------------------|-------------------------------|
| JIM-JIM-90C-0707 | 7/16 JICM x 7/16 JICM 90° |
| JIM-JIM-90C-0808 | 1/2 JICM x 1/2 JICM 90° |
| JIM-JIM-90C-0809 | 1/2 JICM x 9/16 JICM 90° |
| JIM-JIM-90C-0909 | 9/16 JICM x 9/16 JICM 90° |
| JIM-JIM-90C-0912 | 9/16 JICM x 3/4 JICM 90° |
| JIM-JIM-90C-1212 | 3/4 JICM x 3/4 JICM 90° |
| JIM-JIM-90C-1214 | 3/4 JICM x 7/8 JICM 90° |
| JIM-JIM-90C-1217 | 3/4 JICM x 1-1/16 JICM 90° |
| JIM-JIM-90C-1414 | 7/8 JICM x 7/8 JICM 90° |
| JIM-JIM-90C-1417 | 7/8 JICM x 1-1/16 JICM 90° |
| JIM-JIM-90C-1717 | 1-1/16 JICM x 1-1/16 JICM 90° |
| JIM-JIM-90C-1721 | 1-1/16 JICM x 1-5/16 JICM 90° |
| JIM-JIM-90C-2121 | 1-5/16 JICM x 1-5/16 JICM 90° |
| JIM-JIM-90C-2626 | 1-5/8 JICM x 1-5/8 JICM 90° |
| JIM-JIM-90C-3030 | 1-7/8 JICM x 1-7/8 JICM 90° |
| JIM-JIM-90C-4040 | 2-1/2 JICM x 2-1/2 JICM 90° |

JIC Male x UNO Male 90 Degree

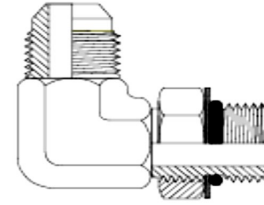

| | |
|--------------------|------------------------------------|
| JIM-UNM-90C-0707 | 7/16 JICM x 7/16 UNOM 90° |
| JIM-UNM-90C-0708 | 7/16 JICM x 1/2 UNOM 90° |
| JIM-UNM-90C-0709 | 7/16 JICM x 9/16 UNOM 90° |
| JIM-UNM-90C-0712 | 7/16 JICM x 3/4 UNOM 90° |
| JIM-UNM-90C-0808 | 1/2 JICM x 1/2 UNOM 90° |
| JIM-UNM-90C-0809 | 1/2 JICM x 9/16 UNOM 90° |
| JIM-UNM-90C-0907 | 9/16 JICM x 7/16 UNOM 90° |
| JIM-UNM-90C-0908 | 9/16 JICM x 1/2 UNOM 90° |
| JIM-UNM-90C-0909 | 9/16 JICM x 9/16 UNOM 90° |
| JIM-UNM-90C-0909E | 9/16 JICM x 9/16 UNOM 90° EXT |
| JIM-UNM-90C-0909EE | 9/16 JICM x 9/16 UNOM 90° EXT Long |
| JIM-UNM-90C-0912 | 9/16 JICM x 3/4 UNOM 90° |
| JIM-UNM-90C-0914 | 9/16 JICM x 7/8 UNOM 90° |
| JIM-UNM-90C-0917 | 9/16 JICM x 1-1/16 UNOM 90° |
| JIM-UNM-90C-1207 | 3/4 JICM x 7/16 UNOM 90° |
| JIM-UNM-90C-1209 | 3/4 JICM x 9/16 UNOM 90° |
| JIM-UNM-90C-1212 | 3/4 JICM x 3/4 UNOM 90° |
| JIM-UNM-90C-1214 | 3/4 JICM x 7/8 UNOM 90° |
| JIM-UNM-90C-1217 | 3/4 JICM x 1-1/16 UNOM 90° |
| JIM-UNM-90C-1221 | 3/4 JICM x 1-5/16 UNOM 90° |
| JIM-UNM-90C-1409 | 7/8 JICM x 9/16 UNOM 90° |
| JIM-UNM-90C-1412 | 7/8 JICM x 3/4 UNOM 90° |
| JIM-UNM-90C-1414 | 7/8 JICM x 7/8 UNOM 90° |
| JIM-UNM-90C-1417 | 7/8 JICM x 1-1/16 UNOM 90° |
| JIM-UNM-90C-1712 | 1-1/16 JICM x 3/4 UNOM 90° |
| JIM-UNM-90C-1714 | 1-1/16 JICM x 7/8 UNOM 90° |
| JIM-UNM-90C-1717 | 1-1/16 JICM x 1-1/16 UNOM 90° |
| JIM-UNM-90C-1719 | 1-1/16 JICM x 1-3/16 UNOM 90° |
| JIM-UNM-90C-1721 | 1-1/16 JICM x 1-5/16 UNOM 90° |
| JIM-UNM-90C-2117 | 1-5/16 JICM x 1-1/16 UNOM 90° |
| JIM-UNM-90C-2121 | 1-5/16 JICM x 1-5/16 UNOM 90° |
| JIM-UNM-90C-2126 | 1-5/16 JICM x 1-5/8 UNOM 90° |
| JIM-UNM-90C-2130 | 1-5/16 JICM x 1-7/8 UNOM 90° |
| JIM-UNM-90C-2621 | 1-5/8 JICM x 1-5/16 UNOM 90° |
| JIM-UNM-90C-2626 | 1-5/8 JICM x 1-5/8 UNOM 90° |
| JIM-UNM-90C-2630 | 1-5/8 JICM x 1-7/8 UNOM 90° |
| JIM-UNM-90C-3026 | 1-7/8 JICM x 1-5/8 UNOM 90° |
| JIM-UNM-90C-3030 | 1-7/8 JICM x 1-7/8 UNOM 90° |
| JIM-UNM-90C-4040 | 2-1/2 JICM x 2-1/2 UNOM 90° |

JIC Male x Metric Male Stud 90 Degree

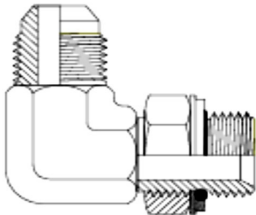

| | |
|------------------|-------------------------------|
| JIM-MSM-90C-0914 | 9/16 JICM x 14mm Metric 90° |
| JIM-MSM-90C-0916 | 9/16 JICM x 16mm Metric 90° |
| JIM-MSM-90C-0918 | 9/16 JICM x 18mm Metric 90° |
| JIM-MSM-90C-1216 | 3/4 JICM x 16mm Metric 90° |
| JIM-MSM-90C-1218 | 3/4 JICM x 18mm Metric 90° |
| JIM-MSM-90C-1222 | 3/4 JICM x 22mm Metric 90° |
| JIM-MSM-90C-1420 | 7/8 JICM x 20mm Metric 90° |
| JIM-MSM-90C-1422 | 7/8 JICM x 22mm Metric 90° |
| JIM-MSM-90C-1722 | 1-1/16 JICM x 22mm Metric 90° |

NPT Female x JIC Male 90 Degree

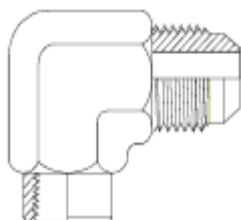

| | |
|------------------|--------------------------|
| NTF-JIM-90C-0407 | 1/4 NPTF x 7/16 JICM 90° |
| NTF-JIM-90C-0409 | 1/4 NPTF x 9/16 JICM 90° |
| NTF-JIM-90C-0609 | 3/8 NPTF x 9/16 JICM 90° |
| NTF-JIM-90C-0812 | 1/2 NPTF x 3/4 JICM 90° |

NPT Female x NPT Female Fixed 90 Degree

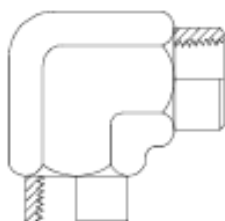

| | |
|------------------|-----------------------------|
| NTF-NTF-90C-0202 | 1/8 NPTF x 1/8 NPTF 90° |
| NTF-NTF-90C-0404 | 1/4 NPTF x 1/4 NPTF 90° |
| NTF-NTF-90C-0606 | 3/8 NPTF x 3/8 NPTF 90° |
| NTF-NTF-90C-0808 | 1/2 NPTF x 1/2 NPTF 90° |
| NTF-NTF-90C-1212 | 3/4 NPTF x 3/4 NPTF 90° |
| NTF-NTF-90C-1616 | 1 NPTF x 1 NPTF 90° |
| NTF-NTF-90C-2020 | 1-1/4 NPTF x 1-1/4 NPTF 90° |
| NTF-NTF-90C-2424 | 1-1/2 NPTF x 1-1/2 NPTF 90° |
| NTF-NTF-90C-3232 | 2 NPTF x 2 NPTF 90° |

NPT Male x JIC Female Swivel 90 Degree

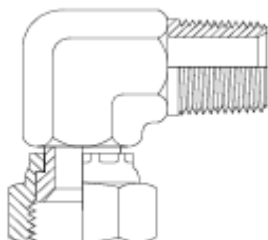

| | |
|------------------|-----------------------------|
| NTM-JIF-90C-0609 | 3/8 NPTM x 9/16 JICFS 90° |
| NTM-JIF-90C-0812 | 1/2 NPTM x 3/4 JICFS 90° |
| NTM-JIF-90C-0814 | 1/2 NPTM x 7/8 JICFS 90° |
| NTM-JIF-90C-1217 | 3/4 NPTM x 1-1/16 JICFS 90° |

NPT Male x JIC Male 90 Degree

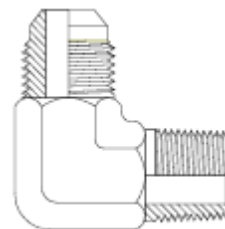

| | |
|---------------------|-------------------------------|
| NTM-JIM-90C-0207 | 1/8 NPTM x 7/16 JICM 90° |
| NTM-JIM-90C-0207E | 1/8 NPTM x 7/16 JICM 90° 30mm |
| NTM-JIM-90C-0207EE | 1/8 NPTM x 7/16 JICM 90° 40mm |
| NTM-JIM-90C-0207EEE | 1/8 NPTM x 7/16 JICM 90° 58mm |
| NTM-JIM-90C-0208 | 1/8 NPTM x 1/2 JICM 90° |
| NTM-JIM-90C-0209 | 1/8 NPTM x 9/16 JICM 90° |
| NTM-JIM-90C-0407 | 1/4 NPTM x 7/16 JICM 90° |
| NTM-JIM-90C-0408 | 1/4 NPTM x 1/2 JICM 90° |
| NTM-JIM-90C-0409 | 1/4 NPTM x 9/16 JICM 90° |
| NTM-JIM-90C-0409E | 1/4 NPTM x 9/16 JICM 90° 30mm |
| NTM-JIM-90C-0409EE | 1/4 NPTM x 9/16 JICM 90° 40mm |
| NTM-JIM-90C-0412 | 1/4 NPTM x 3/4 JICM 90° |
| NTM-JIM-90C-0607 | 3/8 NPTM x 7/16 JICM 90° |
| NTM-JIM-90C-0609 | 3/8 NPTM x 9/16 JICM 90° |
| NTM-JIM-90C-0612 | 3/8 NPTM x 3/4 JICM 90° |
| NTM-JIM-90C-0614 | 3/8 NPTM x 7/8 JICM 90° |
| NTM-JIM-90C-0807 | 1/2 NPTM x 7/16 JICM 90° |
| NTM-JIM-90C-0809 | 1/2 NPTM x 9/16 JICM 90° |
| NTM-JIM-90C-0812 | 1/2 NPTM x 3/4 JICM 90° |
| NTM-JIM-90C-0814 | 1/2 NPTM x 7/8 JICM 90° |
| NTM-JIM-90C-0814E | 1/2 NPTM x 7/8 JICM 90° 30mm |
| NTM-JIM-90C-0817 | 1/2 NPTM x 1-1/16 JICM 90° |
| NTM-JIM-90C-1209 | 3/4 NPTM x 9/16 JICM 90° |
| NTM-JIM-90C-1212 | 3/4 NPTM x 3/4 JICM 90° |
| NTM-JIM-90C-1214 | 3/4 NPTM x 7/8 JICM 90° |
| NTM-JIM-90C-1217 | 3/4 NPTM x 1-1/16 JICM 90° |
| NTM-JIM-90C-1221 | 3/4 NPTM x 1-5/16 JICM 90° |
| NTM-JIM-90C-1617 | 1 NPTM x 1-1/16 JICM 90° |
| NTM-JIM-90C-1621 | 1 NPTM x 1-5/16 JICM 90° |
| NTM-JIM-90C-1626 | 1 NPTM x 1-5/8 JICM 90° |
| NTM-JIM-90C-2021 | 1-1/4 NPTM x 1-5/16 JICM 90° |
| NTM-JIM-90C-2026 | 1-1/4 NPTM x 1-5/8 JICM 90° |
| NTM-JIM-90C-2030 | 1-1/4 NPTM x 1-7/8 JICM 90° |
| NTM-JIM-90C-2421 | 1-1/2 NPTM x 1-5/16 JICM 90° |
| NTM-JIM-90C-2426 | 1-1/2 NPTM x 1-5/8 JICM 90° |
| NTM-JIM-90C-2430 | 1-1/2 NPTM x 1-7/8 JICM 90° |
| NTM-JIM-90C-3240 | 2 NPTM x 2-1/2 JICM 90° |

NPT Male x NPT Female Swivel 90 Degree

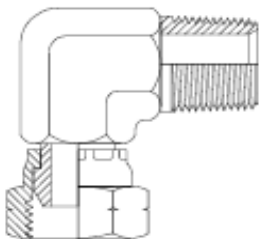

| | |
|------------------|------------------------------|
| NTM-NSF-90C-0202 | 1/8 NPTM x 1/8 NPTSF 90° |
| NTM-NSF-90C-0404 | 1/4 NPTM x 1/4 NPTSF 90° |
| NTM-NSF-90C-0406 | 1/4 NPTM x 3/8 NPTSF 90° |
| NTM-NSF-90C-0604 | 3/8 NPTM x 1/4 NPTSF 90° |
| NTM-NSF-90C-0606 | 3/8 NPTM x 3/8 NPTSF 90° |
| NTM-NSF-90C-0608 | 3/8 NPTM x 1/2 NPTSF 90° |
| NTM-NSF-90C-0804 | 1/2 NPTM x 1/4 NPTSF 90° |
| NTM-NSF-90C-0806 | 1/2 NPTM x 3/8 NPTSF 90° |
| NTM-NSF-90C-0808 | 1/2 NPTM x 1/2 NPTSF 90° |
| NTM-NSF-90C-0812 | 1/2 NPTM x 3/4 NPTSF 90° |
| NTM-NSF-90C-1208 | 3/4 NPTM x 1/2 NPTSF 90° |
| NTM-NSF-90C-1212 | 3/4 NPTM x 3/4 NPTSF 90° |
| NTM-NSF-90C-1216 | 3/4 NPTM x 1 NPTSF 90° |
| NTM-NSF-90C-2020 | 1-1/4 NPTM x 1-1/4 NPTSF 90° |

NPT Male x NPT Male 90 Degree

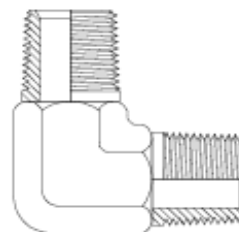

| | |
|------------------|-----------------------------|
| NTM-NTM-90C-0202 | 1/8 NPTM x 1/8 NPTM 90° |
| NTM-NTM-90C-0404 | 1/4 NPTM x 1/4 NPTM 90° |
| NTM-NTM-90C-0406 | 1/4 NPTM x 3/8 NPTM 90° |
| NTM-NTM-90C-0606 | 3/8 NPTM x 3/8 NPTM 90° |
| NTM-NTM-90C-0608 | 3/8 NPTM x 1/2 NPTM 90° |
| NTM-NTM-90C-0808 | 1/2 NPTM x 1/2 NPTM 90° |
| NTM-NTM-90C-0812 | 1/2 NPTM x 3/4 NPTM 90° |
| NTM-NTM-90C-1212 | 3/4 NPTM x 3/4 NPTM 90° |
| NTM-NTM-90C-1616 | 1 NPTM x 1 NPTM 90° |
| NTM-NTM-90C-2020 | 1-1/4 NPTM x 1-1/4 NPTM 90° |
| NTM-NTM-90C-2424 | 1-1/2 NPTM x 1-1/2 NPTM 90° |
| NTM-NTM-90C-3232 | 2 NPTM x 2 NPTM 90° |

NPT Male x NPT Fixed Female 90 Degree

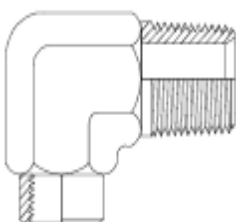

| | |
|------------------|-----------------------------|
| NTM-NTF-90C-0202 | 1/8 NPTM x 1/8 NPTF 90° |
| NTM-NTF-90C-0404 | 1/4 NPTM x 1/4 NPTF 90° |
| NTM-NTF-90C-0604 | 3/8 NPTM x 1/4 NPTF 90° |
| NTM-NTF-90C-0606 | 3/8 NPTM x 3/8 NPTF 90° |
| NTM-NTF-90C-0808 | 1/2 NPTM x 1/2 NPTF 90° |
| NTM-NTF-90C-0812 | 1/2 NPTM x 3/4 NPTF 90° |
| NTM-NTF-90C-1208 | 3/4 NPTM x 1/2 NPTF 90° |
| NTM-NTF-90C-1212 | 3/4 NPTM x 3/4 NPTF 90° |
| NTM-NTF-90C-1616 | 1 NPTM x 1 NPTF 90° |
| NTM-NTF-90C-2020 | 1-1/4 NPTM x 1-1/4 NPTF 90° |
| NTM-NTF-90C-2424 | 1-1/2 NPTM x 1-1/2 NPTF 90° |
| NTM-NTF-90C-3232 | 2 NPTM x 2 NPTF 90° |

NPT Male x ORFS Male 90 Degree

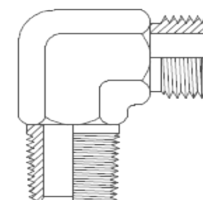

| | |
|------------------|-----------------------------|
| NTM-ORM-90C-0409 | 1/4 NPTM x 9/16 ORFSM 90° |
| NTM-ORM-90C-0411 | 1/4 NPTM x 11/16 ORFSM 90° |
| NTM-ORM-90C-0609 | 3/8 NPTM x 9/16 ORFSM 90° |
| NTM-ORM-90C-0613 | 3/8 NPTM x 13/16 ORFSM 90° |
| NTM-ORM-90C-0813 | 1/2 NPTM x 13/16 ORFSM 90° |
| NTM-ORM-90C-0816 | 1/2 NPTM x 1 ORFSM 90° |
| NTM-ORM-90C-1216 | 3/4 NPTM x 1 ORFSM 90° |
| NTM-ORM-90C-1219 | 3/4 NPTM x 1-3/16 ORFSM 90° |
| NTM-ORM-90C-1619 | 1 NPTM x 1-3/16 ORFSM 90° |

NPT Male x UNO Male 90 Degree

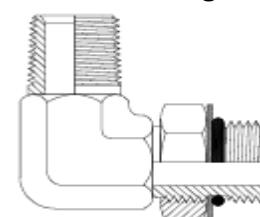

| | |
|------------------|----------------------------|
| NTM-UNM-90C-0407 | 1/4 NPTM x 7/16 UNOM 90° |
| NTM-UNM-90C-1217 | 3/4 NPTM x 1-1/16 UNOM 90° |

ORFS Male x ORFS Female Swivel 90 Degree

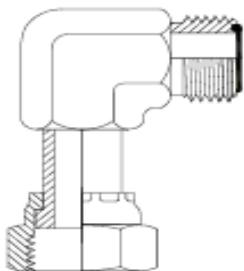

| | |
|------------------|-----------------------------------|
| ORM-ORF-90C-0909 | 9/16 ORFSM x 9/16 ORFSF 90° |
| ORM-ORF-90C-1111 | 11/16 ORFSM x 11/16 ORFSF 90° |
| ORM-ORF-90C-1313 | 13/16 ORFSM x 13/16 ORFSF 90° |
| ORM-ORF-90C-1616 | 1 ORFSM x 1 ORFSF 90° |
| ORM-ORF-90C-1919 | 1-3/16 ORFSM x 1-3/16 ORFSF 90° |
| ORM-ORF-90C-2323 | 1-7/16 ORFSM x 1-7/16 ORFSF 90° |
| ORM-ORF-90C-2727 | 1-11/16 ORFSM x 1-11/16 ORFSF 90° |
| ORM-ORF-90C-3232 | 2 ORFSM x 2 ORFSF 90° |

ORFS Male x UNO Male 90 Degree

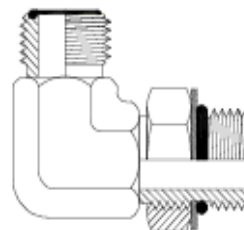

| | |
|------------------|--------------------------------|
| ORM-UNM-90C-0907 | 9/16 ORFSM x 7/16 UNOM 90° |
| ORM-UNM-90C-0909 | 9/16 ORFSM x 9/16 UNOM 90° |
| ORM-UNM-90C-1107 | 11/16 ORFSM x 7/16 UNOM 90° |
| ORM-UNM-90C-1108 | 11/16 ORFSM x 1/2 UNOM 90° |
| ORM-UNM-90C-1109 | 11/16 ORFSM x 9/16 UNOM 90° |
| ORM-UNM-90C-1112 | 11/16 ORFSM x 3/4 UNOM 90° |
| ORM-UNM-90C-1114 | 11/16 ORFSM x 7/8 UNOM 90° |
| ORM-UNM-90C-1309 | 13/16 ORFSM x 9/16 UNOM 90° |
| ORM-UNM-90C-1312 | 13/16 ORFSM x 3/4 UNOM 90° |
| ORM-UNM-90C-1314 | 13/16 ORFSM x 7/8 UNOM 90° |
| ORM-UNM-90C-1317 | 13/16 ORFSM x 1-1/16 UNOM 90° |
| ORM-UNM-90C-1612 | 1 ORFSM x 3/4 UNOM 90° |
| ORM-UNM-90C-1614 | 1 ORFSM x 7/8 UNOM 90° |
| ORM-UNM-90C-1617 | 1 ORFSM x 1-1/16 UNOM 90° |
| ORM-UNM-90C-1912 | 1-3/16 ORFSM x 3/4 UNOM 90° |
| ORM-UNM-90C-1914 | 1-3/16 ORFSM x 7/8 UNOM 90° |
| ORM-UNM-90C-1917 | 1-3/16 ORFSM x 1-1/16 UNOM 90° |
| ORM-UNM-90C-1921 | 1-3/16 ORFSM x 1-5/16 UNOM 90° |
| ORM-UNM-90C-2317 | 1-7/16 ORFSM x 1-1/16 UNOM 90° |
| ORM-UNM-90C-2321 | 1-7/16 ORFSM x 1-5/16 UNOM 90° |
| ORM-UNM-90C-2726 | 1-11/16 ORFSM x 1-5/8 UNOM 90° |
| ORM-UNM-90C-2730 | 1-11/16 ORFSM x 1-7/8 UNOM 90° |

ORFS Male x ORFS Male 90 Degree

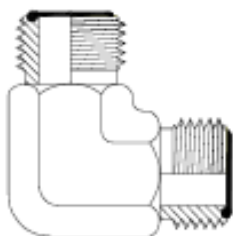

| | |
|------------------|-----------------------------------|
| ORM-ORM-90C-0909 | 9/16 ORFSM x 9/16 ORFSM 90° |
| ORM-ORM-90C-1111 | 11/16 ORFSM x 11/16 ORFSM 90° |
| ORM-ORM-90C-1313 | 13/16 ORFSM x 13/16 ORFSM 90° |
| ORM-ORM-90C-1616 | 1ORFSM x 1ORFSM 90° |
| ORM-ORM-90C-1919 | 1-3/16 ORFSM x 1-3/16 ORFSM 90° |
| ORM-ORM-90C-2323 | 1-7/16 ORFSM x 1-7/16ORFSM 90° |
| ORM-ORM-90C-2727 | 1-11/16 ORFSM x 1-11/16 ORFSM 90° |

Bulkheads

BSPP Male x BSPP Bulkhead

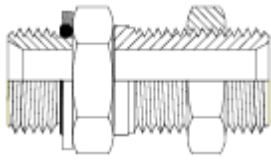

| | |
|--------------|---------------------|
| BPM-BBM-0202 | 1/8 BSPP Bulkhead |
| BPM-BBM-0404 | 1/4 BSPP Bulkhead |
| BPM-BBM-0606 | 3/8 BSPP Bulkhead |
| BPM-BBM-0808 | 1/2 BSPP Bulkhead |
| BPM-BBM-1212 | 3/4 BSPP Bulkhead |
| BPM-BBM-1616 | 1 BSPP Bulkhead |
| BPM-BBM-2020 | 1-1/4 BSPP Bulkhead |
| BPM-BBM-2424 | 1-1/2 BSPP Bulkhead |
| BPM-BBM-3232 | 2 BSPP Bulkhead |

BSPP Male x JIC Male Bulkhead

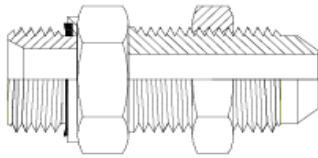

| | |
|--------------|-------------------------------|
| BPM-JBM-0407 | 1/4 BSPP x 7/16 JICM Bulkhead |
| BPM-JBM-0609 | 3/8 BSPP x 9/16 JICM Bulkhead |
| BPM-JBM-0812 | 1/2 BSPP x 3/4 JICM Bulkhead |
| BPM-JBM-0814 | 1/2 BSPP x 7/8 JICM Bulkhead |

JIC Male x JIC Bulkhead

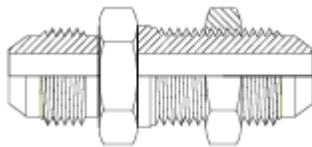

| | |
|--------------|----------------------|
| JIM-JBM-0707 | 7/16 JICM Bulkhead |
| JIM-JBM-0808 | 1/2 JICM Bulkhead |
| JIM-JBM-0909 | 9/16 JICM Bulkhead |
| JIM-JBM-1212 | 3/4 JICM Bulkhead |
| JIM-JBM-1414 | 7/8 JICM Bulkhead |
| JIM-JBM-1717 | 1-1/16 JICM Bulkhead |
| JIM-JBM-2121 | 1-5/16 JICM Bulkhead |
| JIM-JBM-2626 | 1-5/8 JICM Bulkhead |
| JIM-JBM-3030 | 1-7/8 JICM Bulkhead |
| JIM-JBM-4040 | 2 JICM Bulkhead |

NPT Fixed Female x JIC Bulkhead

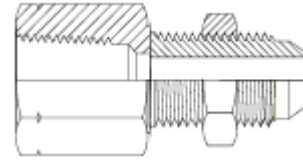

| | |
|--------------|-------------------------------|
| NTF-JBM-0407 | 1/4 NPTF x 7/16 JICM Bulkhead |
| NTF-JBM-0607 | 3/8 NPTF x 7/16 JICM Bulkhead |
| NTF-JBM-0609 | 3/8 NPTF x 9/16 JICM Bulkhead |
| NTF-JBM-0814 | 1/2 NPTF x 7/8 JICM Bulkhead |

NPT Male x JIC Bulkhead

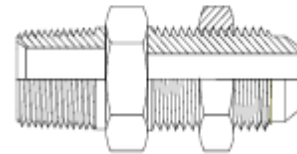

| | |
|--------------|----------------------------------|
| NTM-JBM-0207 | 1/8 NPTM x 7/16 JICM Bulkhead |
| NTM-JBM-0407 | 1/4 NPTM x 9/16 JICM Bulkhead |
| NTM-JBM-0409 | 1/4 NPTM x 7/16 JICM Bulkhead |
| NTM-JBM-0607 | 3/8 NPTM x 7/16 JICM Bulkhead |
| NTM-JBM-0609 | 3/8 NPTM x 9/16 JICM Bulkhead |
| NTM-JBM-0612 | 3/8 NPTM x 3/4 JICM Bulkhead |
| NTM-JBM-0812 | 1/2 NPTM x 3/4 JICM Bulkhead |
| NTM-JBM-0814 | 1/2 NPTM x 7/8 JICM Bulkhead |
| NTM-JBM-0817 | 1/2 NPTM x 1-1/16 JICM Bulkhead |
| NTM-JBM-1217 | 3/4 NPTM x 1-1/16 JICM Bulkhead |
| NTM-JBM-1621 | 1 NPTM x 1-5/16 JICM Bulkhead |
| NTM-JBM-2026 | 1-1/4 NPTM x 1-5/8 JICM Bulkhead |

ORFS Male x ORFS Bulkhead

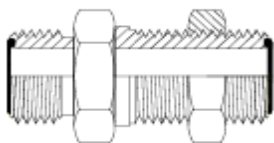

| | |
|--------------|---------------------------|
| ORM-OBM-0909 | 9/16 ORFSM Bulkhead |
| ORM-OBM-1111 | 11/16 ORFSM Bulkhead |
| ORM-OBM-1313 | 13/16 ORFSM Bulkhead |
| ORM-OBM-1316 | 13/16 x 1 ORFSM Bulkhead |
| ORM-OBM-1616 | 1 x 1 ORFSM Bulkhead |
| ORM-OBM-1619 | 1 x 1-3/16 ORFSM Bulkhead |
| ORM-OBM-1919 | 1-3/16 ORFSM Bulkhead |
| ORM-OBM-2323 | 1-7/16 ORFSM Bulkhead |
| ORM-OBM-2727 | 1-11/16 ORFSM Bulkhead |
| ORM-OBM-3232 | 2 ORFSM Bulkhead |

JIC Male x JIC Bulkhead 90 Degree

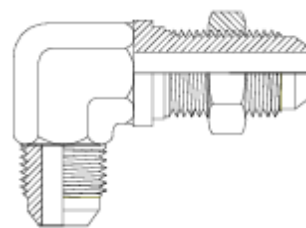

| | |
|------------------|--------------------------|
| JIM-JBM-90C-0707 | 7/16 JICM 90° Bulkhead |
| JIM-JBM-90C-0808 | 1/2 JICM 90° Bulkhead |
| JIM-JBM-90C-0909 | 9/16 JICM 90° Bulkhead |
| JIM-JBM-90C-1212 | 3/4 JICM 90° Bulkhead |
| JIM-JBM-90C-1414 | 7/8 JICM 90° Bulkhead |
| JIM-JBM-90C-1717 | 1-1/16 JICM 90° Bulkhead |
| JIM-JBM-90C-2121 | 1-5/16 JICM 90° Bulkhead |
| JIM-JBM-90C-2626 | 1-5/8 JICM 90° Bulkhead |
| JIM-JBM-90C-3030 | 1-7/8 JICM 90° Bulkhead |

JIC Male x JIC Bulkhead 45 Degree

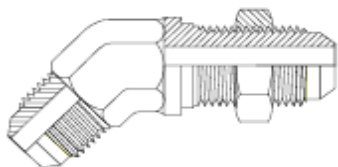

| | |
|------------------|--------------------------|
| JIM-JBM-45C-0707 | 7/16 JICM 45° Bulkhead |
| JIM-JBM-45C-0909 | 9/16 JICM 45° Bulkhead |
| JIM-JBM-45C-1212 | 3/4 JICM 45° Bulkhead |
| JIM-JBM-45C-1414 | 7/8 JICM 45° Bulkhead |
| JIM-JBM-45C-1717 | 1-1/16 JICM 45° Bulkhead |
| JIM-JBM-45C-2121 | 1-5/16 JICM 45° Bulkhead |
| JIM-JBM-45C-2626 | 1-5/8 JICM 45° Bulkhead |

ORFS Male x ORFS Bulkhead 90 Degree

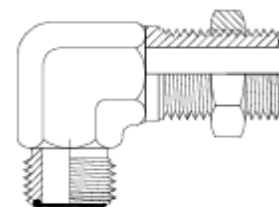

| | |
|------------------|----------------------------|
| ORM-OBM-90C-0909 | 9/16 ORFSM 90° Bulkhead |
| ORM-OBM-90C-1111 | 11/16 ORFSM 90° Bulkhead |
| ORM-OBM-90C-1313 | 13/16 ORFSM 90° Bulkhead |
| ORM-OBM-90C-1616 | 1 ORFSM 90° Bulkhead |
| ORM-OBM-90C-1919 | 1-3/16 ORFSM 90° Bulkhead |
| ORM-OBM-90C-2323 | 1-7/16 ORFSM 90° Bulkhead |
| ORM-OBM-90C-2727 | 1-11/16 ORFSM 90° Bulkhead |

ORFS Male x ORFS Bulkhead 45 Degree

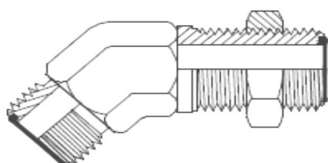

| | |
|------------------|----------------------------|
| ORM-OBM-45C-0909 | 9/16 ORFSM Bulkhead 45° |
| ORM-OBM-45C-1111 | 11/16 ORFSM Bulkhead 45° |
| ORM-OBM-45C-1313 | 13/16 ORFSM Bulkhead 45° |
| ORM-OBM-45C-1616 | 1 ORFSM Bulkhead 45° |
| ORM-OBM-45C-1919 | 1-3/16 ORFSM Bulkhead 45° |
| ORM-OBM-45C-2323 | 1-7/16 ORFSM Bulkhead 45° |
| ORM-OBM-45C-2727 | 1-11/16 ORFSM Bulkhead 45° |

JIC Male / JIC Bulkhead Run Tee

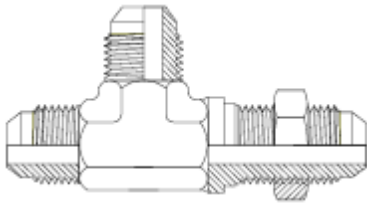

| | |
|--------------------|------------------------------|
| JIM-JBM-JIM-070707 | 7/16 JICM Bulkhead Run Tee |
| JIM-JBM-JIM-090909 | 9/16 JICM Bulkhead Run Tee |
| JIM-JBM-JIM-121212 | 3/4 JICM Bulkhead Run Tee |
| JIM-JBM-JIM-141414 | 7/8 JICM Bulkhead Run Tee |
| JIM-JBM-JIM-171717 | 1-1/16 JICM Bulkhead Run Tee |
| JIM-JBM-JIM-212121 | 1-5/16 JICM Bulkhead Run Tee |
| JIM-JBM-JIM-262626 | 1-5/8 JICM Bulkhead Run Tee |

ORFS Male / ORFS Bulkhead Run Tee

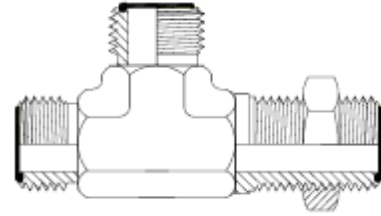

| | |
|--------------------|------------------------------|
| ORM-OBM-ORM-090909 | 9/16 ORFSM Bulkhead Run Tee |
| ORM-OBM-ORM-111111 | 11/16 ORFSM Bulkhead Run Tee |

JIC Male / JIC Bulkhead Branch Tee

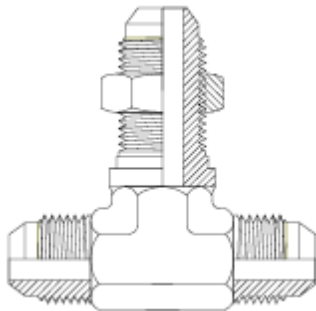

| | |
|--------------------|-------------------------------|
| JIM-JIM-JBM-070707 | 7/16 JICM Bulkhead Drop Tee |
| JIM-JIM-JBM-090909 | 9/16 JICM Bulkhead Drop Tee |
| JIM-JIM-JBM-121212 | 3/4 JICM Bulkhead Drop Tee |
| JIM-JIM-JBM-141414 | 7/8 JICM Bulkhead Drop Tee |
| JIM-JIM-JBM-171717 | 1-1/16 JICM Bulkhead Drop Tee |
| JIM-JIM-JBM-212121 | 1-5/16 JICM Bulkhead Drop Tee |

Tees

BSPP Male / JIC Male / JIC Male Run Tee

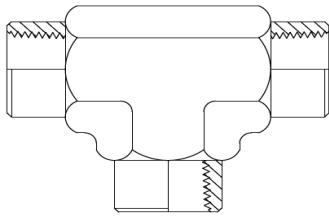

| | |
|--------------------|---------------------|
| BPF-BPF-BPF-040404 | 1/4 BSPP Female Tee |
| BPF-BPF-BPF-060606 | 3/8 BSPP Female Tee |
| BPF-BPF-BPF-080808 | 1/2 BSPP Female Tee |
| BPF-BPF-BPF-121212 | 3/4 BSPP Female Tee |
| BPF-BPF-BPF-161616 | 1 BSPP Female Tee |

BSPP Male / JIC Male / JIC Male Run Tee

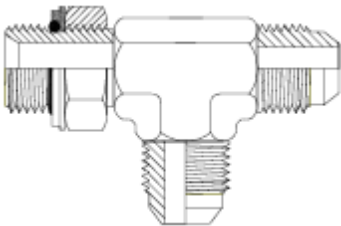

| | |
|--------------------|----------------------------------|
| BPM-JIM-JIM-020707 | 1/8 BSPPM x 7/16 JICM Run Tee |
| BPM-JIM-JIM-020808 | 1/8 BSPPM x 1/2 JICM Run Tee |
| BPM-JIM-JIM-040707 | 1/4 BSPPM x 7/16 JICM Run Tee |
| BPM-JIM-JIM-040909 | 1/4 BSPPM x 9/16 JICM Run Tee |
| BPM-JIM-JIM-060909 | 3/8 BSPPM x 9/16 JICM Run Tee |
| BPM-JIM-JIM-061212 | 3/8 BSPPM x 3/4 JICM Run Tee |
| BPM-JIM-JIM-081212 | 1/2 BSPPM x 3/4 JICM Run Tee |
| BPM-JIM-JIM-081414 | 1/2 BSPPM x 7/8 JICM Run Tee |
| BPM-JIM-JIM-081717 | 1/2 BSPPM x 1-1/16 JICM Run Tee |
| BPM-JIM-JIM-121717 | 3/4 BSPPM x 1-1/16 JICM Run Tee |
| BPM-JIM-JIM-162121 | 1 BSPPM x 1-5/16 JICM Run Tee |
| BPM-JIM-JIM-202626 | 1-1/4 BSPPM x 1-5/8 JICM Run Tee |

BSPT Male / BSPT Female / BSPT Female Tee

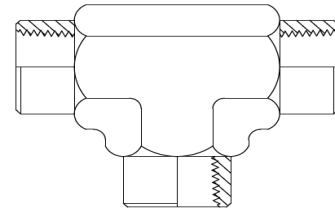

| | |
|--------------------|-----------------------|
| BTF-BTF-BTF-020202 | 1/8 BSPT Female Tee |
| BTF-BTF-BTF-040404 | 1/4 BSPT Female Tee |
| BTF-BTF-BTF-060606 | 3/8 BSPT Female Tee |
| BTF-BTF-BTF-080808 | 1/2 BSPT Female Tee |
| BTF-BTF-BTF-121212 | 3/4 BSPT Female Tee |
| BTF-BTF-BTF-161616 | 1 BSPT Female Tee |
| BTF-BTF-BTF-202020 | 1-1/4 BSPT Female Tee |
| BTF-BTF-BTF-242424 | 1-1/2 BSPT Female Tee |
| BTF-BTF-BTF-323232 | 2 BSPT Female Tee |

BSPT Male / BSPP Female Swivel Run Tee

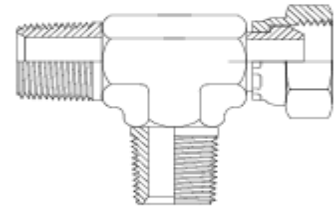

| | |
|--------------------|-----------------------------------|
| BTM-BSF-BTM-040404 | 1/4 BSPTM x 1/4 BSPFS Run Tee |
| BTM-BSF-BTM-060606 | 3/8 BSPTM x 3/8 BSPFS Run Tee |
| BTM-BSF-BTM-080808 | 1/2 BSPTM x 1/2 BSPFS Run Tee |
| BTM-BSF-BTM-121212 | 3/4 BSPTM x 3/4 BSPFS Run Tee |
| BTM-BSF-BTM-161616 | 1 BSPTM x 1 BSPFS Run Tee |
| BTM-BSF-BTM-202020 | 1-1/4 BSPTM x 1-1/4 BSPFS Run Tee |
| BTM-BSF-BTM-242424 | 1-1/2 BSPTM x 1-1/2 BSPFS Run Tee |

BSPT Male / BSPT Female / BSPT Female Run Tee

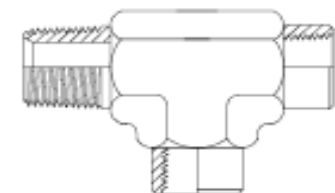

| | |
|--------------------|------------------------|
| BTM-BTF-BTF-020202 | 1/8 BSPT MxFxF Run Tee |
| BTM-BTF-BTF-040404 | 1/4 BSPT MxFxF Run Tee |
| BTM-BTF-BTF-060606 | 3/8 BSPT MxFxF Run Tee |
| BTM-BTF-BTF-080808 | 1/2 BSPT MxFxF Run Tee |
| BTM-BTF-BTF-121212 | 3/4 BSPT MxFxF Run Tee |
| BTM-BTF-BTF-161616 | 1 BSPT MxFxF Run Tee |

BSPT Male / BSPP Female Swivel Branch Tee

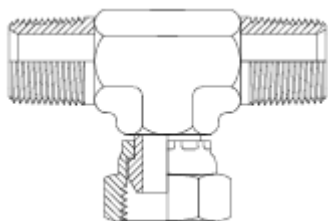

| | |
|--------------------|--------------------------------|
| BTM-BTM-BSF-040404 | 1/4 BSPTM x 1/4 BSPFS Drop Tee |
| BTM-BTM-BSF-060606 | 3/8 BSPTM x 3/8 BSPFS Drop Tee |
| BTM-BTM-BSF-080808 | 1/2 BSPTM x 1/2 BSPFS Drop Tee |
| BTM-BTM-BSF-121212 | 3/4 BSPTM x 3/4 BSPFS Drop Tee |
| BTM-BTM-BSF-161616 | 1 BSPTM x 1 BSPFS Drop Tee |

BSPT Male Tee

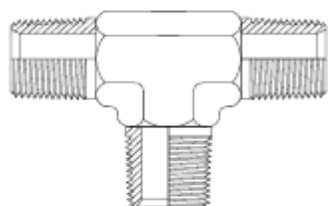

| | |
|--------------------|-----------------|
| BTM-BTM-BTM-020202 | 1/8 BSPTM Tee |
| BTM-BTM-BTM-040404 | 1/4 BSPTM Tee |
| BTM-BTM-BTM-060606 | 3/8 BSPTM Tee |
| BTM-BTM-BTM-080808 | 1/2 BSPTM Tee |
| BTM-BTM-BTM-121212 | 3/4 BSPTM Tee |
| BTM-BTM-BTM-161616 | 1 BSPTM Tee |
| BTM-BTM-BTM-202020 | 1-1/4 BSPTM Tee |
| BTM-BTM-BTM-242424 | 1-1/2 BSPTM Tee |

BSPT Male / JIC Male / JIC Male Run Tee

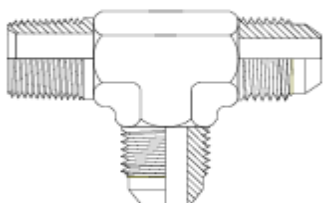

| | |
|--------------------|---------------------------------|
| BTM-JIM-JIM-020707 | 1/8 BSPTM x 7/16 JICM Run Tee |
| BTM-JIM-JIM-040707 | 1/4 BSPTM x 7/16 JICM Run Tee |
| BTM-JIM-JIM-040909 | 1/4 BSPTM x 9/16 JICM Run Tee |
| BTM-JIM-JIM-060909 | 3/8 BSPTM x 9/16 JICM Run Tee |
| BTM-JIM-JIM-061212 | 3/8 BSPTM x 3/4 JICM Run Tee |
| BTM-JIM-JIM-081212 | 1/2 BSPTM x 3/4 JICM Run Tee |
| BTM-JIM-JIM-081414 | 1/2 BSPTM x 7/8 JICM Run Tee |
| BTM-JIM-JIM-121717 | 3/4 BSPTM x 1-1/16 JICM Run Tee |
| BTM-JIM-JIM-162121 | 1 BSPTM x 1-5/16 JICM Run Tee |

JIC Male / JIC Female Swivel Run Tee

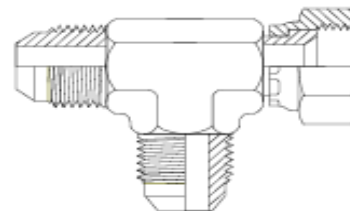

| | |
|--------------------|-------------------------------------|
| JIM-JIF-JIM-070707 | 7/16 JIC Swivel Run Tee |
| JIM-JIF-JIM-080808 | 1/2 JIC Swivel Run Tee |
| JIM-JIF-JIM-090909 | 9/16 JIC Swivel Run Tee |
| JIM-JIF-JIM-121212 | 3/4 JIC Swivel Run Tee |
| JIM-JIF-JIM-141414 | 7/8 JIC Swivel Run Tee |
| JIM-JIF-JIM-141714 | 7/8 JIC x 1-1/16 JIC Swivel Run Tee |
| JIM-JIF-JIM-171717 | 1-1/16 JIC Swivel Run Tee |
| JIM-JIF-JIM-212121 | 1-5/16 JIC Swivel Run Tee |
| JIM-JIF-JIM-262626 | 1-5/8 JIC Swivel Run Tee |
| JIM-JIF-JIM-303030 | 1-7/8 JIC Swivel Run Tee |
| JIM-JIF-JIM-404040 | 2-1/2 JIC Swivel Run Tee |

JIC Male / JIC Male / BSPP Male Branch Tee

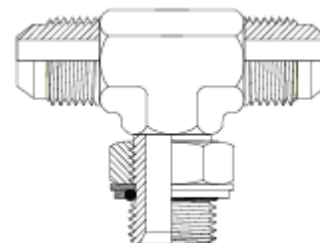

| | |
|--------------------|-----------------------------------|
| JIM-JIM-BPM-070702 | 7/16 JICM x 1/8 BSPPM Drop Tee |
| JIM-JIM-BPM-070704 | 7/16 JICM x 1/4 BSPPM Drop Tee |
| JIM-JIM-BPM-090904 | 9/16 JICM x 1/4 BSPPM Drop Tee |
| JIM-JIM-BPM-090906 | 9/16 JICM x 3/8 BSPPM Drop Tee |
| JIM-JIM-BPM-121206 | 3/4 JICM x 3/8 BSPPM Drop Tee |
| JIM-JIM-BPM-121208 | 3/4 JICM x 1/2 BSPPM Drop Tee |
| JIM-JIM-BPM-141408 | 7/8 JICM x 1/2 BSPPM Drop Tee |
| JIM-JIM-BPM-141412 | 7/8 JICM x 3/4 BSPPM Drop Tee |
| JIM-JIM-BPM-171712 | 1-1/16 JICM x 3/4 BSPPM Drop Tee |
| JIM-JIM-BPM-212116 | 1-5/16 JICM x 1 BSPPM Drop Tee |
| JIM-JIM-BPM-262620 | 1-5/8 JICM x 1-1/4 BSPPM Drop Tee |
| JIM-JIM-BPM-303024 | 1-7/8 JICM x 1-1/2 BSPPM Drop Tee |

JIC Male / JIC Male / BSPT Male Branch Tee

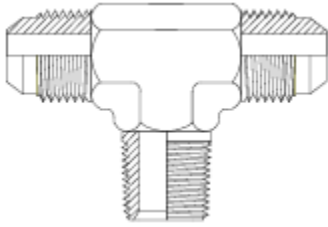

| | |
|--------------------|----------------------------------|
| JIM-JIM-BTM-070702 | 7/16 JICM x 1/8 BSPTM Drop Tee |
| JIM-JIM-BTM-070704 | 7/16 JICM x 1/4 BSPTM Drop Tee |
| JIM-JIM-BTM-090904 | 9/16 JICM x 1/4 BSPTM Drop Tee |
| JIM-JIM-BTM-090906 | 9/16 JICM x 3/8 BSPTM Drop Tee |
| JIM-JIM-BTM-121204 | 3/4 JICM x 1/4 BSPTM Drop Tee |
| JIM-JIM-BTM-121206 | 3/4 JICM x 3/8 BSPTM Drop Tee |
| JIM-JIM-BTM-121208 | 3/4 JICM x 1/2 BSPTM Drop Tee |
| JIM-JIM-BTM-141406 | 7/8 JICM x 3/8 BSPTM Drop Tee |
| JIM-JIM-BTM-141408 | 7/8 JICM x 1/2 BSPTM Drop Tee |
| JIM-JIM-BTM-141412 | 7/8 JICM x 3/4 BSPTM Drop Tee |
| JIM-JIM-BTM-171712 | 1-1/16 JICM x 3/4 BSPTM Drop Tee |
| JIM-JIM-BTM-212116 | 1-5/16 JICM x 1 BSPTM Drop Tee |

JIC Male Tee

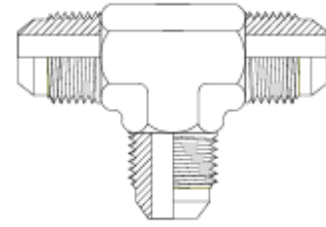

| | |
|--------------------|----------------------------------|
| JIM-JIM-JIM-070707 | 7/16 JIC Male Tee |
| JIM-JIM-JIM-080808 | 1/2 JIC Male Tee |
| JIM-JIM-JIM-090909 | 9/16 JIC Male Tee |
| JIM-JIM-JIM-090912 | 9/16 JIC x 3/4 JIC Male Drop Tee |
| JIM-JIM-JIM-121212 | 3/4 JIC Male Tee |
| JIM-JIM-JIM-141414 | 7/8 JIC Male Tee |
| JIM-JIM-JIM-171717 | 1-1/16 JIC Male Tee |
| JIM-JIM-JIM-212117 | 1-5/16 x 1-1/16 JIC Male Tee |
| JIM-JIM-JIM-212121 | 1-5/16 JIC Male Tee |
| JIM-JIM-JIM-262626 | 1-5/8 JIC Male Tee |
| JIM-JIM-JIM-303030 | 1-7/8 JIC Male Tee |
| JIM-JIM-JIM-404040 | 2-1/2 JIC Male Tee |

JIC Male / JIC Male / JIC Female Swivel Branch Tee

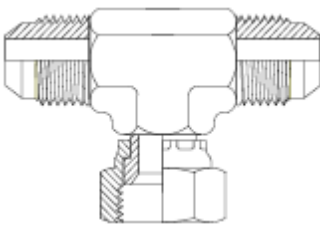

| | |
|--------------------|----------------------------|
| JIM-JIM-JIF-070707 | 7/16 JIC Swivel Drop Tee |
| JIM-JIM-JIF-080808 | 1/2 JIC Swivel Drop Tee |
| JIM-JIM-JIF-090909 | 9/16 JIC Swivel Drop Tee |
| JIM-JIM-JIF-121212 | 3/4 JIC Swivel Drop Tee |
| JIM-JIM-JIF-141414 | 7/8 JIC Swivel Drop Tee |
| JIM-JIM-JIF-171717 | 1-1/16 JIC Swivel Drop Tee |
| JIM-JIM-JIF-212121 | 1-5/16 JIC Swivel Drop Tee |
| JIM-JIM-JIF-262626 | 1-5/8 JIC Swivel Drop Tee |
| JIM-JIM-JIF-303030 | 1-7/8 JIC Swivel Run Tee |
| JIM-JIM-JIF-404040 | 2-1/2 JIC Swivel Drop Tee |

JIC Male / JIC Male / NPT Male Branch Tee

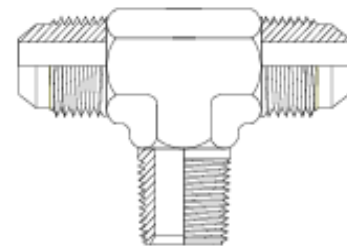

| | |
|--------------------|----------------------------------|
| JIM-JIM-NTM-070702 | 7/16 JICM x 1/8 NPTM Drop Tee |
| JIM-JIM-NTM-070704 | 7/16 JICM x 1/4 NPTM Drop Tee |
| JIM-JIM-NTM-090904 | 9/16 JICM x 1/4 NPTM Drop Tee |
| JIM-JIM-NTM-090906 | 9/16 JICM x 3/8 NPTM Drop Tee |
| JIM-JIM-NTM-090908 | 9/16 JICM x 1/2 NPTM Drop Tee |
| JIM-JIM-NTM-121206 | 3/4 JICM x 3/8 NPTM Drop Tee |
| JIM-JIM-NTM-121208 | 3/4 JICM x 1/2 NPTM Drop Tee |
| JIM-JIM-NTM-141408 | 7/8 JICM x 1/2 NPTM Drop Tee |
| JIM-JIM-NTM-171712 | 1-1/16 JICM x 3/4 NPTM Drop Tee |
| JIM-JIM-NTM-262620 | 1-5/8 JICM x 1-1/4 NPTM Drop Tee |

JIC Male / JIC Male / UNO Male Branch Tee

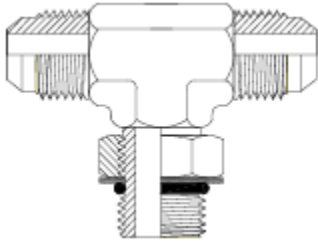

| | |
|--------------------|------------------------------------|
| JIM-JIM-UNM-070707 | 7/16 JICM x 7/16 UNOM Drop Tee |
| JIM-JIM-UNM-090909 | 9/16 JICM x 9/16 UNOM Drop Tee |
| JIM-JIM-UNM-090912 | 9/16 JICM x 3/4 UNOM Drop Tee |
| JIM-JIM-UNM-121212 | 3/4 JICM x 3/4 UNOM Drop Tee |
| JIM-JIM-UNM-121214 | 3/4 JICM x 7/8 UNOM Drop Tee |
| JIM-JIM-UNM-141414 | 7/8 JICM x 7/8 UNOM Drop Tee |
| JIM-JIM-UNM-171717 | 1-1/16 JICM x 1-1/16 UNOM Drop Tee |
| JIM-JIM-UNM-212121 | 1-5/16 JICM x 1-5/16 UNOM Drop Tee |
| JIM-JIM-UNM-262626 | 1-5/8 JICM x 1-5/8 UNOM Drop Tee |
| JIM-JIM-UNM-303030 | 1-7/8 JICM x 1-7/8 UNOM Drop Tee |

JIC Male / UNO Male / JIC Male Run Tee

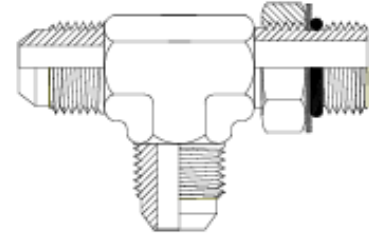

| | |
|--------------------|-----------------------------------|
| JIM-UNM-JIM-070707 | 7/16 JICM x 7/16 UNOM Run Tee |
| JIM-UNM-JIM-090909 | 9/16 JICM x 9/16 UNOM Run Tee |
| JIM-UNM-JIM-120912 | 3/4 JICM x 9/16 UNOM Run Tee |
| JIM-UNM-JIM-121212 | 3/4 JICM x 3/4 UNOM Run Tee |
| JIM-UNM-JIM-141414 | 7/8 JICM x 7/8 UNOM Run Tee |
| JIM-UNM-JIM-171417 | 1-1/16 JICM x 7/8 UNOM Run Tee |
| JIM-UNM-JIM-171717 | 1-1/16 JICM x 1-1/16 UNOM Run Tee |
| JIM-UNM-JIM-212121 | 1-5/16 JICM x 1-5/16 UNOM Run Tee |
| JIM-UNM-JIM-262626 | 1-5/8 JIC x 1-5/8 UNOM Run Tee |

JIC Male / NPT Male / JIC Male Run Tee

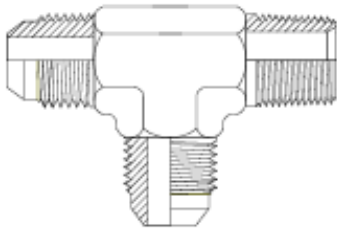

| | |
|--------------------|--------------------------------|
| JIM-NTM-JIM-070207 | 7/16 JICM x 1/8 NPTM Run Tee |
| JIM-NTM-JIM-070407 | 7/16 JICM x 1/4 NPTM Run Tee |
| JIM-NTM-JIM-090409 | 9/16 JICM x 1/4 NPTM Run Tee |
| JIM-NTM-JIM-090609 | 9/16 JICM x 3/8 NPTM Run Tee |
| JIM-NTM-JIM-120612 | 3/4 JICM x 3/8 NPTM Run Tee |
| JIM-NTM-JIM-120812 | 3/4 JICM x 1/2 NPTM Run Tee |
| JIM-NTM-JIM-171217 | 1-1/16 JICM x 3/4 NPTM Run Tee |

NPT Female Tee

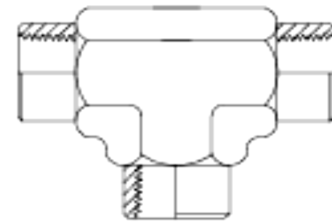

| | |
|--------------------|-----------------------|
| NTF-NTF-NTF-020202 | 1/8 NPTF Female Tee |
| NTF-NTF-NTF-040404 | 1/4 NPTF Female Tee |
| NTF-NTF-NTF-060606 | 3/8 NPTF Female Tee |
| NTF-NTF-NTF-080808 | 1/2 NPTF Female Tee |
| NTF-NTF-NTF-121212 | 3/4 NPTF Female Tee |
| NTF-NTF-NTF-161616 | 1 NPTF Female Tee |
| NTF-NTF-NTF-202020 | 1-1/4 NPTF Female Tee |
| NTF-NTF-NTF-242424 | 1-1/2 NPTF Female Tee |
| NTF-NTF-NTF-323232 | 2 NPTF Female Tee |

NPT Male / NPT Female / NPT Female Run Tee

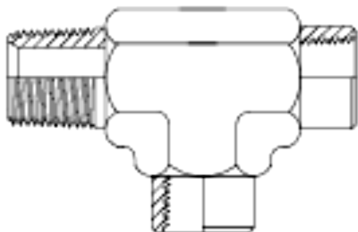

| | |
|--------------------|-------------------------|
| NTM-NTF-NTF-020202 | 1/8 NPT MxFxF Run Tee |
| NTM-NTF-NTF-040404 | 1/4 NPT MxFxF Run Tee |
| NTM-NTF-NTF-060606 | 3/8 NPT MxFxF Run Tee |
| NTM-NTF-NTF-080808 | 1/2 NPT MxFxF Run Tee |
| NTM-NTF-NTF-121212 | 3/4 NPT MxFxF Run Tee |
| NTM-NTF-NTF-202020 | 1-1/4 NPT MxFxF Run Tee |
| NTM-NTF-NTF-242424 | 1-1/2 NPT MxFxF Run Tee |

NPT Male Tee

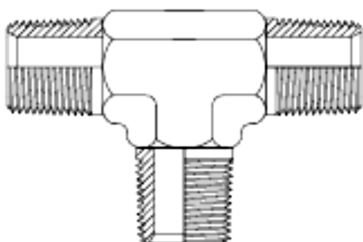

| | |
|--------------------|------------------|
| NTM-NTM-NTM-020202 | 1/8 NPT Male Tee |
| NTM-NTM-NTM-040404 | 1/4 NPT Male Tee |
| NTM-NTM-NTM-060606 | 3/8 NPT Male Tee |
| NTM-NTM-NTM-080808 | 1/2 NPT Male Tee |
| NTM-NTM-NTM-121212 | 3/4 NPT Male Tee |
| NTM-NTM-NTM-161616 | 1 NPT Male Tee |

ORFS Male / ORFS Female Swivel Run Tee

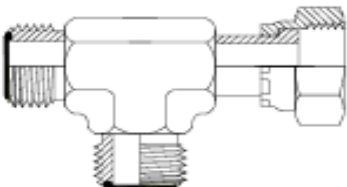

| | |
|--------------------|-----------------------------|
| ORM-ORF-ORM-090909 | 9/16 ORFS Swivel Run Tee |
| ORM-ORF-ORM-111111 | 11/16 ORFS Swivel Run Tee |
| ORM-ORF-ORM-131313 | 13/16 ORFS Swivel Run Tee |
| ORM-ORF-ORM-161616 | 1 ORFS Swivel Run Tee |
| ORM-ORF-ORM-191919 | 1-3/16 ORFS Swivel Run Tee |
| ORM-ORF-ORM-232323 | 1-7/16 ORFS Swivel Run Tee |
| ORM-ORF-ORM-272727 | 1-11/16 ORFS Swivel Run Tee |
| ORM-ORF-ORM-323232 | 2 ORFS Swivel Run Tee |

ORFS Male / ORFS Male / ORFS Female Branch Tee

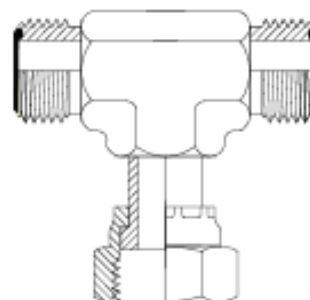

| | |
|--------------------|------------------------------|
| ORM-ORM-ORF-090909 | 9/16 ORFS Swivel Drop Tee |
| ORM-ORM-ORF-111111 | 11/16 Swivel Drop Tee |
| ORM-ORM-ORF-131313 | 13/16 ORFS Swivel Drop Tee |
| ORM-ORM-ORF-161616 | 1 ORFS Swivel Drop Tee |
| ORM-ORM-ORF-191919 | 1-3/16 ORFS Swivel Drop Tee |
| ORM-ORM-ORF-232323 | 1-7/16 ORFS Swivel Drop Tee |
| ORM-ORM-ORF-272727 | 1-11/16 ORFS Swivel Drop Tee |
| ORM-ORM-ORF-323232 | 2 ORFS Swivel Drop Tee |

ORFS Male Tee

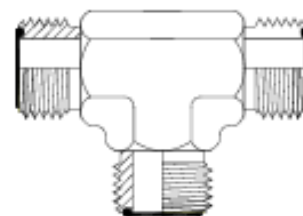

| | |
|--------------------|-----------------------|
| ORM-ORM-ORM-090909 | 9/16 ORFS Male Tee |
| ORM-ORM-ORM-111111 | 11/16 ORFS Male Tee |
| ORM-ORM-ORM-131313 | 13/16 ORFS Male Tee |
| ORM-ORM-ORM-161616 | 1 ORFS Male Tee |
| ORM-ORM-ORM-191919 | 1-3/16 ORFS Male Tee |
| ORM-ORM-ORM-232323 | 1-7/16 ORFS Male Tee |
| ORM-ORM-ORM-272727 | 1-11/16 ORFS Male Tee |
| ORM-ORM-ORM-323232 | 2 ORFS Male Tee |

Test Ports

BSPT Male x BSPP Female Swivel BSPP Test Port

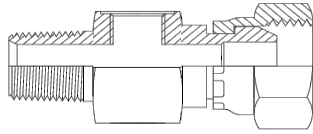

| | |
|--------------------|-----------------------------|
| BTM-BSF-BPF-040402 | 1/4 BSPT M/F Test 1/8 BSPPF |
| BTM-BSF-BPF-060602 | 3/8 BSPT M/F Test 1/8 BSPPF |
| BTM-BSF-BPF-080802 | 1/2 BSPT M/F Test 1/8 BSPPF |
| BTM-BSF-BPF-121202 | 3/4 BSPT M/F Test 1/8 BSPPF |
| BTM-BSF-BPF-161602 | 1 BSPT M/F Test 1/8 BSPPF |

JIC Male x JIC Female Swivel BSPP Test Port

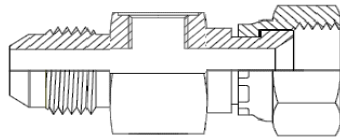

| | |
|--------------------|---------------------------------|
| JIM-JIF-BPF-070702 | 7/16 JIC M/F Test 1/8 BSPPF |
| JIM-JIF-BPF-090902 | 9/16 JIC M/F Test 1/8 BSPPF |
| JIM-JIF-BPF-121202 | 3/4 JIC M/F Test 1/8 BSPPF |
| JIM-JIF-BPF-141402 | 7/8 JIC M/F Test 1/8 BSPPF |
| JIM-JIF-BPF-171702 | 1-1/16 JIC M/F Test 1/8 BSPPF |
| JIM-JIF-BPF-212102 | 1-5/16 JIC M/F x Test 1/8 BSPPF |

ORFS Male x ORFS Female Swivel BSPP Test Port

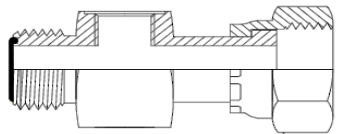

| | |
|--------------------|--------------------------------|
| ORM-ORF-BPF-090902 | 9/16 ORFS M/F Test 1/8 BSPPF |
| ORM-ORF-BPF-111102 | 11/16 ORFS M/F Test 1/8 BSPPF |
| ORM-ORF-BPF-131302 | 13/16 ORFS M/F Test 1/8 BSPPF |
| ORM-ORF-BPF-161602 | 1 ORFS M/F Test 1/8 BSPPF |
| ORM-ORF-BPF-191902 | 1 3/16 ORFS M/F Test 1/8 BSPPF |
| ORM-ORF-BPF-232302 | 1-7/16 ORFS M/F Test 1/8 BSPPF |

Metric Light Male x Metric Light Female Swivel BSPP Test Port

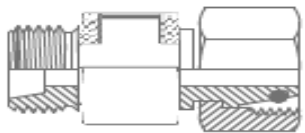

| | |
|--------------------|-------------------------------|
| MLM-MLF-BPF-222202 | 22MM (15L) M/F Test 1/8 BSPPF |
| MLM-MLF-BPF-262602 | 26MM (18L) M/F Test 1/8 BSPPF |

Cross

BSPT Female Cross

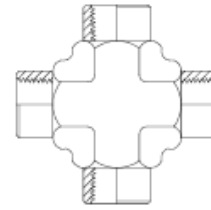

| | |
|--------------------------|-----------------|
| BTF-BTF-BTF-BTF-04040404 | 1/4 BSPTF Cross |
| BTF-BTF-BTF-BTF-06060606 | 3/8 BSPTF Cross |
| BTF-BTF-BTF-BTF-08080808 | 1/2 BSPTF Cross |
| BTF-BTF-BTF-BTF-12121212 | 3/4 BSPTF Cross |
| BTF-BTF-BTF-BTF-16161616 | 1 BSPTF Cross |

JIC Male Cross

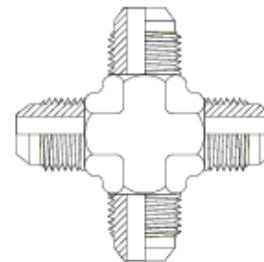

| | |
|--------------------------|-------------------|
| JIM-JIM-JIM-JIM-07070707 | 7/16 JICM Cross |
| JIM-JIM-JIM-JIM-09090909 | 9/16 JICM Cross |
| JIM-JIM-JIM-JIM-12121212 | 3/4 JICM Cross |
| JIM-JIM-JIM-JIM-14141414 | 7/8 JICM Cross |
| JIM-JIM-JIM-JIM-17171717 | 1-1/16 JICM Cross |
| JIM-JIM-JIM-JIM-21212121 | 1-5/16 JICM Cross |

NPT Female Cross

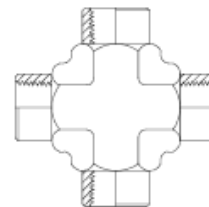

| | |
|--------------------------|----------------|
| NTF-NTF-NTF-NTF-02020202 | 1/8 NPTF Cross |
| NTF-NTF-NTF-NTF-04040404 | 1/4 NPTF Cross |
| NTF-NTF-NTF-NTF-06060606 | 3/8 NPTF Cross |
| NTF-NTF-NTF-NTF-08080808 | 1/2 NPTF Cross |
| NTF-NTF-NTF-NTF-12121212 | 3/4 NPTF Cross |
| NTF-NTF-NTF-NTF-16161616 | 1 NPTF Cross |

Caps & Plugs

JIS (BSP) Female Cap

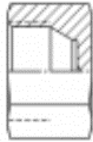

| | |
|--------|-----------------|
| BJF-04 | 1/4 JIS BSP Cap |
| BJF-06 | 3/8 JIS BSP Cap |
| BJF-08 | 1/2 JIS BSP Cap |
| BJF-12 | 3/4 JIS BSP Cap |
| BJF-16 | 1 JIS BSP Cap |

JIS (BSP) Male Plug

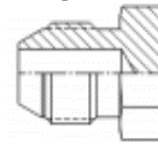

| | |
|--------|------------------|
| BJM-02 | 1/8 JIS BSP Plug |
| BJM-04 | 1/4 JIS BSP Plug |
| BJM-06 | 3/8 JIS BSP Plug |
| BJM-08 | 1/2 JIS BSP Plug |
| BJM-12 | 3/4 JIS BSP Plug |
| BJM-16 | 1 JIS BSP Plug |

BSPP Female Cap

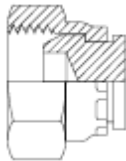

| | |
|--------|-----------------|
| BSF-02 | 1/8 BSPFS Cap |
| BSF-04 | 1/4 BSPFS Cap |
| BSF-06 | 3/8 BSPFS Cap |
| BSF-08 | 1/2 BSPFS Cap |
| BSF-12 | 3/4 BSPFS Cap |
| BSF-16 | 1 BSPFS Cap |
| BSF-20 | 1-1/4 BSPFS Cap |
| BSF-24 | 1-1/2 BSPFS Cap |
| BSF-32 | 2 BSPFS Cap |

BSPP Male Plug

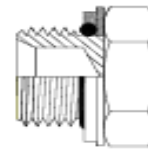

| | |
|--------|-----------------|
| BPM-02 | 1/8 BSPP Plug |
| BPM-04 | 1/4 BSPP Plug |
| BPM-06 | 3/8 BSPP Plug |
| BPM-08 | 1/2 BSPP Plug |
| BPM-10 | 5/8 BSPP Plug |
| BPM-12 | 3/4 BSPP Plug |
| BPM-16 | 1 BSPP Plug |
| BPM-20 | 1-1/4 BSPP Plug |
| BPM-24 | 1-1/2 BSPP Plug |
| BPM-32 | 2 BSPP Plug |

BSPP Male In Hex Plug



| | |
|-----------|------------------------------|
| BPM-CS-02 | 1/8 BSPP Counter Sunk Plug |
| BPM-CS-04 | 1/4 BSPP Counter Sunk Plug |
| BPM-CS-06 | 3/8 BSPP Counter Sunk Plug |
| BPM-CS-08 | 1/2 BSPP Counter Sunk Plug |
| BPM-CS-12 | 3/4 BSPP Counter Sunk Plug |
| BPM-CS-16 | 1 BSPP Counter Sunk Plug |
| BPM-CS-20 | 1-1/4 BSPP Counter Sunk Plug |
| BPM-CS-24 | 1-1/2 BSPP Counter Sunk Plug |

BSPT Male Plug

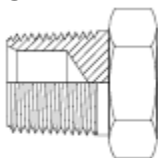

| | |
|--------|------------------|
| BTM-02 | 1/8 BSPTM Plug |
| BTM-04 | 1/4 BSPTM Plug |
| BTM-06 | 3/8 BSPTM Plug |
| BTM-08 | 1/2 BSPTM Plug |
| BTM-10 | 5/8 BSPTM Plug |
| BTM-12 | 3/4 BSPTM Plug |
| BTM-16 | 1 BSPTM Plug |
| BTM-20 | 1-1/4 BSPTM Plug |
| BTM-24 | 1-1/2 BSPTM Plug |
| BTM-32 | 2 BSPTM Plug |

BSPT Male In Hex Plug

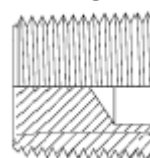

| | |
|-----------|-----------------------------|
| BTM-CS-02 | 1/8 BSPTM Counter Sunk Plug |
| BTM-CS-04 | 1/4 BSPTM Counter Sunk Plug |
| BTM-CS-06 | 3/8 BSPTM Counter Sunk Plug |
| BTM-CS-08 | 1/2 BSPTM Counter Sunk Plug |
| BTM-CS-12 | 3/4 BSPTM Counter Sunk Plug |
| BTM-CS-16 | 1 BSPTM Counter Sunk Plug |

Code 61 Flange Plug



| | |
|-------------|---------------------------|
| F61-PLUG-08 | 1/2 Code 61 Flange Plug |
| F61-PLUG-12 | 3/4 Code 61 Flange Plug |
| F61-PLUG-16 | 1 Code 61 Flange Plug |
| F61-PLUG-20 | 1-1/4 Code 61 Flange Plug |
| F61-PLUG-24 | 1-1/2 Code 61 Flange Plug |
| F61-PLUG-32 | 2 Code 61 Flange Plug |

Code 62 Flange Plug



| | |
|-------------|---------------------------|
| F62-PLUG-12 | 3/4 Code 62 Flange Plug |
| F62-PLUG-16 | 1 Code 62 Flange Plug |
| F62-PLUG-20 | 1-1/4 Code 62 Flange Plug |
| F62-PLUG-24 | 1-1/2 Code 62 Flange Plug |
| F62-PLUG-32 | 2 Code 62 Flange Plug |

JIC Female Cap



| | |
|--------|-----------------|
| JIF-06 | 3/8 JICF Cap |
| JIF-07 | 7/16 JICF Cap |
| JIF-08 | 1/2 JICF Cap |
| JIF-09 | 9/16 JICF Cap |
| JIF-12 | 3/4 JICF Cap |
| JIF-14 | 7/8 JICF Cap |
| JIF-17 | 1-1/16 JICF Cap |
| JIF-19 | 1-3/16 JICF Cap |
| JIF-21 | 1-5/16 JICF Cap |
| JIF-26 | 1-5/8 JICF Cap |
| JIF-30 | 1-7/8 JICF Cap |
| JIF-40 | 2-1/2 JICF Cap |

JIC Male Plug

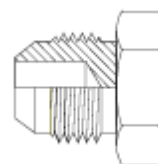

| | |
|--------|------------------|
| JIM-05 | 5/16 JICM Plug |
| JIM-06 | 3/8 JICM Plug |
| JIM-07 | 7/16 JICM Plug |
| JIM-08 | 1/2 JICM Plug |
| JIM-09 | 9/16 JICM Plug |
| JIM-12 | 3/4 JICM Plug |
| JIM-14 | 7/8 JICM Plug |
| JIM-17 | 1-1/16 JICM Plug |
| JIM-19 | 1-3/16 JICM Plug |
| JIM-21 | 1-5/16 JICM Plug |
| JIM-26 | 1-5/8 JICM Plug |
| JIM-30 | 1-7/8 JICM Plug |
| JIM-40 | 2-1/2 JICM Plug |

JIS Metric Female Cap (Komatsu)

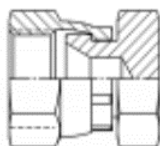

| | |
|--------|-------------------------------|
| MKF-14 | 14mm JIS Metric Cap (Komatsu) |
| MKF-16 | 16mm JIS Metric Cap (Komatsu) |
| MKF-18 | 18mm JIS Metric Cap (Komatsu) |
| MKF-20 | 20mm JIS Metric Cap (Komatsu) |
| MKF-22 | 22mm JIS Metric Cap (Komatsu) |
| MKF-24 | 24mm JIS Metric Cap (Komatsu) |
| MKF-26 | 26mm JIS Metric Cap (Komatsu) |
| MKF-30 | 30mm JIS Metric Cap (Komatsu) |
| MKF-33 | 33mm JIS Metric Cap (Komatsu) |

JIS Metric Male Plug (Komatsu)

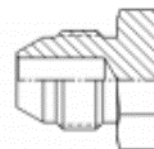

| | |
|--------|--------------------------------|
| MKM-14 | 14mm JIS Metric Plug (Komatsu) |
| MKM-16 | 16mm JIS Metric Plug (Komatsu) |
| MKM-18 | 18mm JIS Metric Plug (Komatsu) |
| MKM-20 | 20mm JIS Metric Plug (Komatsu) |
| MKM-22 | 22mm JIS Metric Plug (Komatsu) |
| MKM-24 | 24mm JIS Metric Plug (Komatsu) |
| MKM-26 | 26mm JIS Metric Plug (Komatsu) |
| MKM-30 | 30mm JIS Metric Plug (Komatsu) |
| MKM-33 | 33mm JIS Metric Plug (Komatsu) |

Metric Port Plug

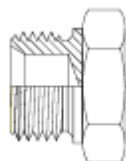

| | |
|------------|--------------------------|
| MSM-10x1 | 10mm x 1mm Metric Plug |
| MSM-12x1.5 | 12mm x 1.5mm Metric Plug |
| MSM-14x1.5 | 14mm x 1.5mm Metric Plug |
| MSM-16x1.5 | 16mm x 1.5mm Metric Plug |
| MSM-18x1.5 | 18mm x 1.5mm Metric Plug |
| MSM-20x1.5 | 20mm x 1.5mm Metric Plug |
| MSM-22x1.5 | 22mm x 1.5mm Metric Plug |
| MSM-24x1.5 | 24mm x 1.5mm Metric Plug |
| MSM-26x1.5 | 26mm x 1.5mm Metric Plug |
| MSM-27x2 | 27mm x 2mm Metric Plug |
| MSM-27x1.5 | 27mm x 1.5mm Metric Plug |
| MSM-30x2 | 30mm x 2mm Metric Plug |
| MSM-30x1.5 | 30mm x 1.5mm Metric Plug |
| MSM-33x2 | 33mm x 2mm Metric Plug |
| MSM-33x1.5 | 33mm x 1.5mm Metric Plug |
| MSM-38x2 | 38mm x 2mm Metric Plug |
| MSM-38x1.5 | 38mm x 1.5mm Metric Plug |
| MSM-42x2 | 42mm x 2mm Metric Plug |

Metric Port In Hex Plug



| | |
|-----------|-------------------------------|
| MSM-CS-10 | 10mm x 1mm Countersunk Plug |
| MSM-CS-12 | 12mm x 1.5mm Countersunk Plug |
| MSM-CS-14 | 14mm x 1.5mm Countersunk Plug |
| MSM-CS-16 | 16mm x 1.5mm Countersunk Plug |
| MSM-CS-18 | 18mm x 1.5mm Countersunk Plug |
| MSM-CS-20 | 20mm x 1.5mm Countersunk Plug |
| MSM-CS-22 | 22mm x 1.5mm Countersunk Plug |
| MSM-CS-24 | 24mm x 1.5mm Countersunk Plug |
| MSM-CS-26 | 26mm x 1.5mm Countersunk Plug |
| MSM-CS-27 | 27mm x 2mm Countersunk Plug |
| MSM-CS-33 | 33mm x 2mm Countersunk Plug |
| MSM-CS-42 | 42mm x 2mm Countersunk Plug |

NPT Female Cap



| | |
|--------|--------------|
| NTF-04 | 1/4 NPTF Cap |
| NTF-06 | 3/8 NPTF Cap |
| NTF-08 | 1/2 NPTF Cap |
| NTF-12 | 3/4 NPTF Cap |
| NTF-16 | 1 NPTF Cap |

ORFS Female Cap

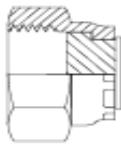

| | |
|--------|------------------|
| ORF-09 | 9/16 ORFS Cap |
| ORF-11 | 11/16 ORFS Cap |
| ORF-13 | 13/16 ORFS Cap |
| ORF-16 | 1 ORFS Cap |
| ORF-19 | 1-3/16 ORFS Cap |
| ORF-23 | 1-7/16 ORFS Cap |
| ORF-27 | 1-11/16 ORFS Cap |
| ORF-32 | 2 ORFS Cap |

UNO Plug

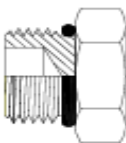

| | |
|--------|-----------------|
| UNM-06 | 3/8 UNO Plug |
| UNM-07 | 7/16 UNO Plug |
| UNM-08 | 1/2 UNO Plug |
| UNM-09 | 9/16 UNO Plug |
| UNM-12 | 3/4 UNO Plug |
| UNM-14 | 7/8 UNO Plug |
| UNM-17 | 1-1/16 UNO Plug |
| UNM-19 | 1-3/16 UNO Plug |
| UNM-21 | 1-5/16 UNO Plug |
| UNM-26 | 1-5/8 UNO Plug |
| UNM-30 | 1-7/8 UNO Plug |
| UNM-40 | 2-1/2 UNO Plug |

NPT Male Plug

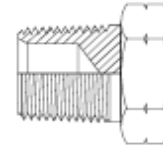

| | |
|--------|-----------------|
| NTM-02 | 1/8 NPTM Plug |
| NTM-04 | 1/4 NPTM Plug |
| NTM-06 | 3/8 NPTM Plug |
| NTM-08 | 1/2 NPTM Plug |
| NTM-12 | 3/4 NPTM Plug |
| NTM-16 | 1 NPTM Plug |
| NTM-20 | 1-1/4 NPTM Plug |
| NTM-24 | 1-1/2 NPTM Plug |
| NTM-32 | 2 NPTM Plug |

ORFS Male Plug

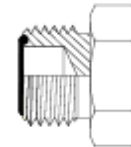

| | |
|--------|-------------------|
| ORM-09 | 9/16 ORFS Plug |
| ORM-11 | 11/16 ORFS Plug |
| ORM-13 | 13/16 ORFS Plug |
| ORM-16 | 1 ORFS Plug |
| ORM-19 | 1-3/16 ORFS Plug |
| ORM-23 | 1-7/16 ORFS Plug |
| ORM-27 | 1-11/16 ORFS Plug |
| ORM-32 | 2 ORFS Plug |

UNO In Hex Plug

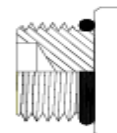

| | |
|-----------|-----------------------------|
| UNM-CS-05 | 5/16 UNO Plug Countersunk |
| UNM-CS-06 | 3/8 UNO Plug Countersunk |
| UNM-CS-07 | 7/16 UNO Plug Countersunk |
| UNM-CS-08 | 1/2 UNO Plug Countersunk |
| UNM-CS-09 | 9/16 UNO Plug Countersunk |
| UNM-CS-12 | 3/4 UNO Plug Countersunk |
| UNM-CS-14 | 7/8 UNO Plug Countersunk |
| UNM-CS-17 | 1-1/16 UNO Plug Countersunk |
| UNM-CS-21 | 1-5/16 UNO Plug Countersunk |
| UNM-CS-26 | 1-5/8 UNO Plug Countersunk |
| UNM-CS-30 | 1-7/8 UNO Plug Countersunk |

Plastic Caps & Plugs



BSP CAPS

| | |
|--------|----------------------|
| PCB-04 | 1/4" BSP PLASTIC CAP |
| PCB-06 | 3/8" BSP PLASTIC CAP |
| PCB-08 | 1/2" BSP PLASTIC CAP |
| PCB-12 | 3/4" BSP PLASTIC CAP |
| PCB-16 | 1" BSP PLASTIC CAP |

JIC CAPS

| | |
|--------|-------------------------|
| PCJ-07 | 7/16" JIC PLASTIC CAP |
| PCJ-09 | 9/16" JIC PLASTIC CAP |
| PCJ-12 | 3/4" JIC PLASTIC CAP |
| PCJ-14 | 7/8" JIC PLASTIC CAP |
| PCJ-17 | 1-1/16" JIC PLASTIC CAP |
| PCJ-21 | 1-5/16" JIC PLASTIC CAP |

BSP PLUGS

| | |
|--------|-------------------------|
| PPB-04 | 1/4" BSP PLASTIC PLUG |
| PPB-06 | 3/8" BSP PLASTIC PLUG |
| PPB-08 | 1/2" BSP PLASTIC PLUG |
| PPB-12 | 3/4" BSP PLASTIC PLUG |
| PPB-16 | 1" BSP PLASTIC PLUG |
| PPB-20 | 1-1/4" BSP PLASTIC PLUG |
| PPB-24 | 1-1/2" BSP PLASTIC PLUG |
| PPB-32 | 2" BSP PLASTIC PLUG |

JIC PLUGS

| | |
|--------|--------------------------|
| PPJ-07 | 7/16" JIC PLASTIC PLUG |
| PPJ-09 | 9/16" JIC PLASTIC PLUG |
| PPJ-12 | 3/4" JIC PLASTIC PLUG |
| PPJ-14 | 7/8" JIC PLASTIC PLUG |
| PPJ-17 | 1-1/16" JIC PLASTIC PLUG |
| PPJ-21 | 1-5/16" JIC PLASTIC PLUG |
| PPJ-26 | 1-5/8" JIC PLASTIC PLUG |
| PPJ-30 | 1-7/8" JIC PLASTIC PLUG |
| PPJ-40 | 2-1/2" JIC PLASTIC PLUG |

ORFS CAPS

| | |
|--------|--------------------------|
| PCO-11 | 11/16" ORFS PLASTIC CAP |
| PCO-13 | 13/16" ORFS PLASTIC CAP |
| PCO-16 | 1" ORFS PLASTIC CAP |
| PCO-19 | 1-3/16" ORFS PLASTIC CAP |
| PCO-23 | 1-7/16" ORFS PLASTIC CAP |

ORFS PLUGS

| | |
|--------|----------------------------|
| PPO-13 | 13/16" ORFS PLASTIC PLUG |
| PPO-16 | 1" ORFS PLASTIC PLUG |
| PPO-19 | 1-3/16" ORFS PLASTIC PLUG |
| PPO-23 | 1-7/16" ORFS PLASTIC PLUG |
| PPO-27 | 1-11/16" ORFS PLASTIC PLUG |
| PPO-32 | 2" ORFS PLASTIC PLUG |

The background of the slide is a solid olive green color. Overlaid on this background is a technical drawing of a mechanical part, possibly a piston or a similar component. The drawing is rendered in a light yellow or gold color. It features a central cylindrical body with various diameters and a flange-like structure at the top. Dashed lines indicate hidden or internal features of the part, while solid lines represent the visible outer surfaces. The drawing is oriented diagonally, from the top-left towards the bottom-right.

METRIC COMPRESSION

Straight

BSPF Fixed Female x Metric Heavy Male

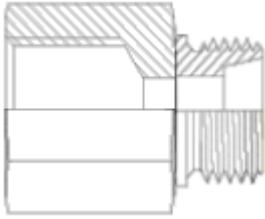

| | |
|--------------|---------------------|
| BPF-MHM-0414 | 1/4 BSPPF x 6S M |
| BPF-MHM-0416 | 1/4 BSPPF x 8S M |
| BPF-MHM-0618 | 3/8 BSPPF x 10S M |
| BPF-MHM-0620 | 3/8 BSPPF x 12S M |
| BPF-MHM-0822 | 1/2 BSPPF x 14S M |
| BPF-MHM-0824 | 1/2 BSPPF x 16S M |
| BPF-MHM-1230 | 3/4 BSPPF x 20S M |
| BPF-MHM-1636 | 1 BSPPF x 25S M |
| BPF-MHM-2042 | 1-1/4 BSPPF x 30S M |
| BPF-MHM-2452 | 1-1/2 BSPPF x 38S M |

BSPF Fixed Female x Metric Light Male

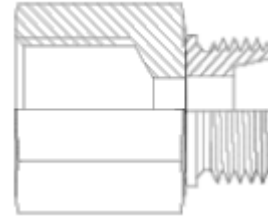

| | |
|--------------|---------------------|
| BPF-MLM-0212 | 1/8 BSPPF x 6L M |
| BPF-MLM-0414 | 1/4 BSPPF x 8L M |
| BPF-MLM-0416 | 1/4 BSPPF x 10L M |
| BPF-MLM-0618 | 3/8 BSPPF x 12L M |
| BPF-MLM-0822 | 1/2 BSPPF x 15L M |
| BPF-MLM-0826 | 1/2 BSPPF x 18L M |
| BPF-MLM-1230 | 3/4 BSPPF x 22L M |
| BPF-MLM-1636 | 1 BSPPF x 28L M |
| BPF-MLM-2045 | 1-1/4 BSPPF x 35L M |
| BPF-MLM-2452 | 1-1/2 BSPPF x 42L M |

BSP Male x Metric Heavy Female

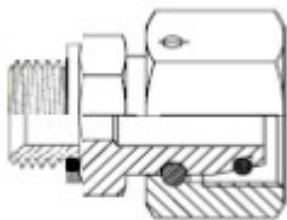

BSP Male x Metric Light Female

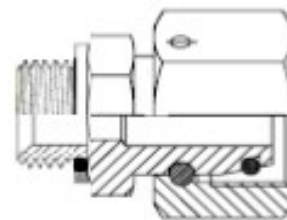

| | |
|--------------|---------------------|
| BPM-MHF-0214 | 1/8 BSPPM x 6S F |
| BPM-MHF-0414 | 1/4 BSPPM x 6S F |
| BPM-MHF-0416 | 1/4 BSPPM x 8S F |
| BPM-MHF-0418 | 1/4 BSPPM x 10S F |
| BPM-MHF-0420 | 1/4 BSPPM x 12S F |
| BPM-MHF-0616 | 3/8 BSPPM x 8S F |
| BPM-MHF-0618 | 3/8 BSPPM x 10S F |
| BPM-MHF-0620 | 3/8 BSPPM x 12S F |
| BPM-MHF-0622 | 3/8 BSPPM x 14S F |
| BPM-MHF-0624 | 3/8 BSPPM x 16S F |
| BPM-MHF-0818 | 1/2 BSPPM x 10S F |
| BPM-MHF-0820 | 1/2 BSPPM x 12S F |
| BPM-MHF-0822 | 1/2 BSPPM x 14S F |
| BPM-MHF-0824 | 1/2 BSPPM x 16S F |
| BPM-MHF-0830 | 1/2 BSPPM x 20S F |
| BPM-MHF-0836 | 1/2 BSPPM x 25S F |
| BPM-MHF-1224 | 3/4 BSPPM x 16S F |
| BPM-MHF-1230 | 3/4 BSPPM x 20S F |
| BPM-MHF-1236 | 3/4 BSPPM x 25S F |
| BPM-MHF-1630 | 1 BSPPM x 20S F |
| BPM-MHF-1636 | 1 BSPPM x 25S F |
| BPM-MHF-1642 | 1 BSPPM x 30S F |
| BPM-MHF-2036 | 1-1/4 BSPPM x 25S F |
| BPM-MHF-2042 | 1-1/4 BSPPM x 30S F |
| BPM-MHF-2052 | 1-1/4 BSPPM x 38S F |
| BPM-MHF-2442 | 1-1/2 BSPPM x 30S F |
| BPM-MHF-2452 | 1-1/2 BSPPM x 38S F |

| | |
|--------------|---------------------|
| BPM-MLF-0212 | 1/8 BSPPM x 6L F |
| BPM-MLF-0412 | 1/4 BSPPM x 6L F |
| BPM-MLF-0414 | 1/4 BSPPM x 8L F |
| BPM-MLF-0416 | 1/4 BSPPM x 10L F |
| BPM-MLF-0418 | 1/4 BSPPM x 12L F |
| BPM-MLF-0614 | 3/8 BSPPM x 8L F |
| BPM-MLF-0616 | 3/8 BSPPM x 10L F |
| BPM-MLF-0618 | 3/8 BSPPM x 12L F |
| BPM-MLF-0622 | 3/8 BSPPM x 15L F |
| BPM-MLF-0818 | 1/2 BSPPM x 12L F |
| BPM-MLF-0822 | 1/2 BSPPM x 15L F |
| BPM-MLF-0826 | 1/2 BSPPM x 18L F |
| BPM-MLF-1222 | 3/4 BSPPM x 15L F |
| BPM-MLF-1226 | 3/4 BSPPM x 18L F |
| BPM-MLF-1230 | 3/4 BSPPM x 22L F |
| BPM-MLF-1236 | 3/4 BSPPM x 28L F |
| BPM-MLF-1630 | 1 BSPPM x 22L F |
| BPM-MLF-1636 | 1 BSPPM x 28L F |
| BPM-MLF-1645 | 1 BSPPM x 35L F |
| BPM-MLF-2045 | 1-1/4 BSPPM x 35L F |
| BPM-MLF-2445 | 1-1/2 BSPPM x 35L F |
| BPM-MLF-2452 | 1-1/2 BSPPM x 42L F |

BSPM Male x Metric Heavy Male

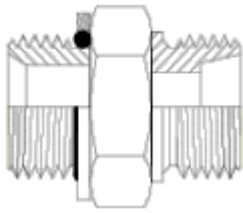

BSPM Male x Metric Light Male

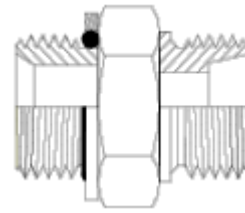

| | |
|--------------|---------------------|
| BPM-MHM-0214 | 1/4 BSPPM x 6S M |
| BPM-MHM-0414 | 1/4 BSPPM x 6S M |
| BPM-MHM-0416 | 1/4 BSPPM x 8S M |
| BPM-MHM-0418 | 1/4 BSPPM x 10S M |
| BPM-MHM-0420 | 1/4 BSPPM x 12S M |
| BPM-MHM-0616 | 3/8 BSPPM x 8S M |
| BPM-MHM-0618 | 3/8 BSPPM x 10S M |
| BPM-MHM-0620 | 3/8 BSPPM x 12S M |
| BPM-MHM-0622 | 3/8 BSPPM x 14S M |
| BPM-MHM-0624 | 3/8 BSPPM x 16S M |
| BPM-MHM-0818 | 1/2 BSPPM x 10S M |
| BPM-MHM-0820 | 1/2 BSPPM x 12S M |
| BPM-MHM-0822 | 1/2 BSPPM x 14S M |
| BPM-MHM-0824 | 1/2 BSPPM x 16S M |
| BPM-MHM-0830 | 1/2 BSPPM x 20S M |
| BPM-MHM-0836 | 1/2 BSPPM x 25S M |
| BPM-MHM-1224 | 3/4 BSPPM x 16S M |
| BPM-MHM-1230 | 3/4 BSPPM x 20S M |
| BPM-MHM-1236 | 3/4 BSPPM x 25S M |
| BPM-MHM-1630 | 1 BSPPM x 20S M |
| BPM-MHM-1636 | 1 BSPPM x 25S M |
| BPM-MHM-1642 | 1 BSPPM x 30S M |
| BPM-MHM-2042 | 1-1/4 BSPPM x 30S M |
| BPM-MHM-2052 | 1-1/4 BSPPM x 38S M |
| BPM-MHM-2452 | 1-1/2 BSPPM x 38S M |

| | |
|---------------|---------------------|
| BPM-MLLM-0210 | 1/8 BSPPM x 6LL M |
| BPM-MLM-0212 | 1/8 BSPPM x 6L M |
| BPM-MLM-0214 | 1/8 BSPPM x 8L M |
| BPM-MLM-0216 | 1/8 BSPPM x 10L M |
| BPM-MLM-0412 | 1/4 BSPPM x 6L M |
| BPM-MLM-0414 | 1/4 BSPPM x 8L M |
| BPM-MLM-0416 | 1/4 BSPPM x 10L M |
| BPM-MLM-0418 | 1/4 BSPPM x 12L M |
| BPM-MLM-0612 | 3/8 BSPPM x 6L M |
| BPM-MLM-0614 | 3/8 BSPPM x 8L M |
| BPM-MLM-0616 | 3/8 BSPPM x 10L M |
| BPM-MLM-0618 | 3/8 BSPPM x 12L M |
| BPM-MLM-0622 | 3/8 BSPPM x 15L M |
| BPM-MLM-0814 | 1/2 BSPPM x 8L M |
| BPM-MLM-0816 | 1/2 BSPPM x 10L M |
| BPM-MLM-0818 | 1/2 BSPPM x 12L M |
| BPM-MLM-0822 | 1/2 BSPPM x 15L M |
| BPM-MLM-0826 | 1/2 BSPPM x 18L M |
| BPM-MLM-0830 | 1/2 BSPPM x 22L M |
| BPM-MLM-1222 | 3/4 BSPPM x 15L M |
| BPM-MLM-1226 | 3/4 BSPPM x 18L M |
| BPM-MLM-1230 | 3/4 BSPPM x 22L M |
| BPM-MLM-1236 | 3/4 BSPPM x 28L M |
| BPM-MLM-1630 | 1 BSPPM x 22L M |
| BPM-MLM-1636 | 1 BSPPM x 28L M |
| BPM-MLM-1645 | 1 BSPPM x 35L M |
| BPM-MLM-2045 | 1-1/4 BSPPM x 35L M |
| BPM-MLM-2052 | 1-1/4 BSPPM x 42L M |
| BPM-MLM-2452 | 1-1/2 BSPPM x 42L M |

BSPT Male x Metric Heavy Male

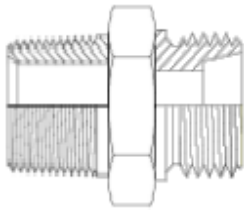

| | |
|--------------|---------------------|
| BTM-MHM-0414 | 1/4 BSPTM x 6S M |
| BTM-MHM-0416 | 1/4 BSPTM x 8S M |
| BTM-MHM-0618 | 3/8 BSPTM x 10S M |
| BTM-MHM-0620 | 3/8 BSPTM x 12S M |
| BTM-MHM-0622 | 3/8 BSPTM x 14S M |
| BTM-MHM-0624 | 3/8 BSPTM x 16S M |
| BTM-MHM-0816 | 1/2 BSPTM x 16S M |
| BTM-MHM-0818 | 1/2 BSPTM x 18S M |
| BTM-MHM-0820 | 1/2 BSPTM x 12S M |
| BTM-MHM-0822 | 1/2 BSPTM x 14S M |
| BTM-MHM-0824 | 1/2 BSPTM x 16S M |
| BTM-MHM-0830 | 1/2 BSPTM x 20S M |
| BTM-MHM-1230 | 3/4 BSPTM x 20S M |
| BTM-MHM-1236 | 3/4 BSPTM x 25S M |
| BTM-MHM-1636 | 1 BSPTM x 25S M |
| BTM-MHM-1642 | 1 BSPTM x 30S M |
| BTM-MHM-2042 | 1-1/4 BSPTM x 30S M |
| BTM-MHM-2452 | 1-1/2 BSPTM x 38S M |

BSPT Male x Metric Light Male

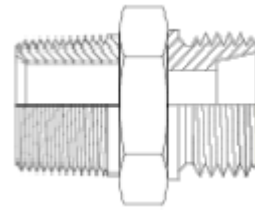

| | |
|---------------|---------------------|
| BTM-MLLM-0210 | 1/8 BSPTM x 6LL M |
| BTM-MLM-0212 | 1/8 BSPTM x 6L M |
| BTM-MLM-0214 | 1/8 BSPTM x 8L M |
| BTM-MLM-0216 | 1/8 BSPTM x 10L M |
| BTM-MLM-0412 | 1/4 BSPTM x 6L M |
| BTM-MLM-0414 | 1/4 BSPTM x 8L M |
| BTM-MLM-0416 | 1/4 BSPTM x 10L M |
| BTM-MLM-0418 | 1/4 BSPTM x 12L M |
| BTM-MLM-0614 | 3/8 BSPTM x 8L M |
| BTM-MLM-0616 | 3/8 BSPTM x 10L M |
| BTM-MLM-0618 | 3/8 BSPTM x 12L M |
| BTM-MLM-0622 | 3/8 BSPTM x 15L M |
| BTM-MLM-0814 | 1/2 BSPTM x 10L M |
| BTM-MLM-0816 | 1/2 BSPTM x 10L M |
| BTM-MLM-0818 | 1/2 BSPTM x 12L M |
| BTM-MLM-0822 | 1/2 BSPTM x 15L M |
| BTM-MLM-0826 | 1/2 BSPTM x 18L M |
| BTM-MLM-1226 | 3/4 BSPTM x 18LM |
| BTM-MLM-1230 | 3/4 BSPTM x 22L M |
| BTM-MLM-1636 | 1 BSPTM x 22L M |
| BTM-MLM-1636 | 1 BSPTM x 28L M |
| BTM-MLM-2045 | 1-1/4 BSPTM x 35L M |
| BTM-MLM-2452 | 1-1/2 BSPTM x 42L M |

JIC Male x Metric Heavy Male

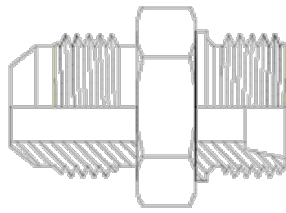

JIC Male x Metric Light Male

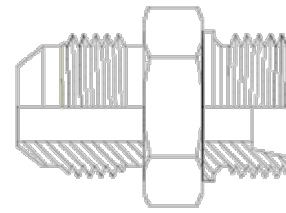

| | |
|--------------|---------------------|
| JIM-MHM-0716 | 7/16 JICM x 8S M |
| JIM-MHM-0914 | 9/16 JICM x 6S M |
| JIM-MHM-0916 | 9/16 JICM x 8S M |
| JIM-MHM-0918 | 9/16 JICM x 10S M |
| JIM-MHM-0920 | 9/16 JICM x 12S M |
| JIM-MHM-0922 | 9/16 JICM x 14S M |
| JIM-MHM-1218 | 3/4 JICM x 10S M |
| JIM-MHM-1220 | 3/4 JICM x 12S M |
| JIM-MHM-1222 | 3/4 JICM x 14S M |
| JIM-MHM-1224 | 3/4 JICM x 16S M |
| JIM-MHM-1230 | 3/4 JICM x 20S M |
| JIM-MHM-1422 | 7/8 JICM x 14S M |
| JIM-MHM-1424 | 7/8 JICM x 16S M |
| JIM-MHM-1430 | 7/8 JICM x 20S M |
| JIM-MHM-1724 | 1-1/16 JICM x 16S M |
| JIM-MHM-1730 | 1-1/16 JICM x 20S M |
| JIM-MHM-1736 | 1-1/16 JICM x 25S M |
| JIM-MHM-2136 | 1-5/16 JICM x 25S M |
| JIM-MHM-2142 | 1-5/16 JICM x 30S M |

| | |
|--------------|---------------------|
| JIM-MLM-0712 | 7/16 JICM x 8L M |
| JIM-MLM-0714 | 7/16 JICM x 8L M |
| JIM-MLM-0716 | 7/16 JICM x 10L M |
| JIM-MLM-0912 | 9/16 JICM x 6L M |
| JIM-MLM-0914 | 9/16 JICM x 8L M |
| JIM-MLM-0916 | 9/16 JICM x 10L M |
| JIM-MLM-0918 | 9/16 JICM x 12L M |
| JIM-MLM-0922 | 9/16 JICM x 15L M |
| JIM-MLM-1216 | 3/4 JICM x 10L M |
| JIM-MLM-1218 | 3/4 JICM x 12L M |
| JIM-MLM-1222 | 3/4 JICM x 15L M |
| JIM-MLM-1226 | 3/4 JICM x 18L M |
| JIM-MLM-1422 | 7/8 JICM x 15L M |
| JIM-MLM-1722 | 1-1/16 JICM x 15L M |
| JIM-MLM-1726 | 1-1/16 JICM x 18L M |
| JIM-MLM-1730 | 1-1/16 JICM x 22L M |
| JIM-MLM-2136 | 1-5/16 JICM x 28L M |
| JIM-MLM-2645 | 1-5/8 JICM x 35L M |

Metric Heavy Female Compression Union

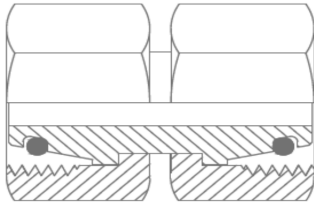

Metric Light Female Compression Union

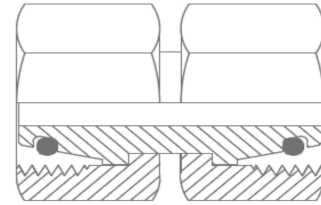

| | |
|--------------|---------------|
| MHF-MHF-1414 | 6S F/F |
| MHF-MHF-1416 | 6S x 8S F/F |
| MHF-MHF-1418 | 6S x 10S F/F |
| MHF-MHF-1420 | 6S x 12S F/F |
| MHF-MHF-1616 | 8S F/F |
| MHF-MHF-1618 | 8S x 10SF/F |
| MHF-MHF-1620 | 8S x 12SF/F |
| MHF-MHF-1818 | 10S F/F |
| MHF-MHF-1820 | 10Sx 12S F/F |
| MHF-MHF-1824 | 10S x 16S F/F |
| MHF-MHF-2020 | 12S F/F |
| MHF-MHF-2024 | 12S x 16S F/F |
| MHF-MHF-2030 | 12S x 20S F/F |
| MHF-MHF-2222 | 14S F/F |
| MHF-MHF-2424 | 16S F/F |
| MHF-MHF-2430 | 16S x 20S F/F |
| MHF-MHF-2436 | 16S x 25S F/F |
| MHF-MHF-2442 | 16S x 30S F/F |
| MHF-MHF-3030 | 20S F/F |
| MHF-MHF-3036 | 20S x 25S F/F |
| MHF-MHF-3042 | 20S x 30S F/F |
| MHF-MHF-3052 | 20S x 38S F/F |
| MHF-MHF-3636 | 25S F/F |
| MHF-MHF-3642 | 25S x 30S F/F |
| MHF-MHF-3652 | 25S x 38S F/F |
| MHF-MHF-4242 | 30S F/F |
| MHF-MHF-4252 | 30S x 38S F/F |
| MHF-MHF-5252 | 38S F/F |

| | |
|--------------|---------------|
| MLF-MLF-1212 | 6L F/F |
| MLF-MLF-1214 | 6L x 8L F/F |
| MLF-MLF-1216 | 6L x 10L F/F |
| MLF-MLF-1218 | 6L x 12L F/F |
| MLF-MLF-1414 | 8L F/F |
| MLF-MLF-1416 | 8L x 10L F/F |
| MLF-MLF-1418 | 8L x 12L F/F |
| MLF-MLF-1422 | 8L x 15L F/F |
| MLF-MLF-1616 | 10L F/F |
| MLF-MLF-1618 | 10L x 12L F/F |
| MLF-MLF-1622 | 10L x 15L F/F |
| MLF-MLF-1626 | 10L x 18L F/F |
| MLF-MLF-1818 | 12L F/F |
| MLF-MLF-1822 | 12L x 15L F/F |
| MLF-MLF-1826 | 12L x 18L F/F |
| MLF-MLF-1830 | 12L x 22L F/F |
| MLF-MLF-2222 | 15L F/F |
| MLF-MLF-2226 | 15L x 18L F/F |
| MLF-MLF-2230 | 15L x 22L F/F |
| MLF-MLF-2236 | 15L x 28L F/F |
| MLF-MLF-2626 | 18L F/F |
| MLF-MLF-2630 | 18L x 22L F/F |
| MLF-MLF-2636 | 18L x 28L F/F |
| MLF-MLF-2645 | 18L x 35L F/F |
| MLF-MLF-3030 | 22L F/F |
| MLF-MLF-3036 | 22L x 28L F/F |
| MLF-MLF-3045 | 22L x 35L F/F |
| MLF-MLF-3052 | 22L x 42L F/F |
| MLF-MLF-3636 | 28L F/F |
| MLF-MLF-3645 | 28L x 35L F/F |
| MLF-MLF-3652 | 28L x 42L F/F |
| MLF-MLF-4545 | 35L F/F |
| MLF-MLF-4552 | 35L x 42L F/F |
| MLF-MLF-5252 | 42L F/F |

Metric Heavy Male Compression Union

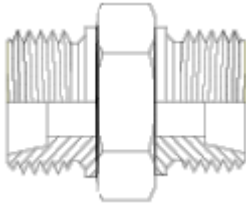

| | |
|--------------|---------------|
| MHM-MHM-1414 | 6S M/M |
| MHM-MHM-1416 | 6S x 8S M/M |
| MHM-MHM-1418 | 6S x 10S M/M |
| MHM-MHM-1420 | 6S x 12S M/M |
| MHM-MHM-1616 | 8S M/M |
| MHM-MHM-1618 | 8S x 10S M/M |
| MHM-MHM-1620 | 8S x 12S M/M |
| MHM-MHM-1818 | 10S M/M |
| MHM-MHM-1820 | 10S x 12S M/M |
| MHM-MHM-1822 | 10S x 14S M/M |
| MHM-MHM-1824 | 10S x 16S M/M |
| MHM-MHM-1830 | 10S x 20S M/M |
| MHM-MHM-2020 | 12S M/M |
| MHM-MHM-2022 | 14S x 12S M/M |
| MHM-MHM-2024 | 12S x 16S M/M |
| MHM-MHM-2030 | 20 x 12S M/M |
| MHM-MHM-2222 | 14S M/M |
| MHM-MHM-2224 | 14S x 16S M/M |
| MHM-MHM-2424 | 16S M/M |
| MHM-MHM-2430 | 16S x 20S M/M |
| MHM-MHM-2436 | 16S x 25S M/M |
| MHM-MHM-3030 | 20S M/M |
| MHM-MHM-3036 | 20S x 25S M/M |
| MHM-MHM-3042 | 20S x 30S M/M |
| MHM-MHM-3636 | 25S M/M |
| MHM-MHM-3642 | 25S x 30S M/M |
| MHM-MHM-4242 | 30S M/M |
| MHM-MHM-4252 | 30S x 38S M/M |
| MHM-MHM-5252 | 38S M/M |

Metric Light Male Compression Union

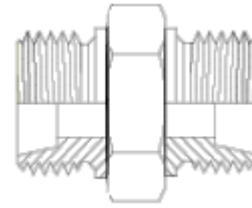

| | |
|----------------|---------------|
| MLLM-MLLM-1010 | 6LL M/M |
| MLM-MLM-1212 | 6L M/M |
| MLM-MLM-1214 | 6L x 8L M/M |
| MLM-MLM-1216 | 6L x 10L M/M |
| MLM-MLM-1218 | 6L x 12L M/M |
| MLM-MLM-1414 | 8L M/M |
| MLM-MLM-1416 | 8L x 10L M/M |
| MLM-MLM-1418 | 8L x 12L M/M |
| MLM-MLM-1616 | 10L M/M |
| MLM-MLM-1618 | 10L x 12L M/M |
| MLM-MLM-1622 | 10L x 15L M/M |
| MLM-MLM-1626 | 10L x 18L M/M |
| MLM-MLM-1818 | 12L M/M |
| MLM-MLM-1822 | 12L x 15L M/M |
| MLM-MLM-1826 | 12L x 18L M/M |
| MLM-MLM-2222 | 15L M/M |
| MLM-MLM-2226 | 15L x 18L M/M |
| MLM-MLM-2230 | 15L x 22L M/M |
| MLM-MLM-2626 | 18L M/M |
| MLM-MLM-2630 | 18L x 22L M/M |
| MLM-MLM-2636 | 18L x 28L M/M |
| MLM-MLM-3030 | 22L M/M |
| MLM-MLM-3036 | 22L x 28L M/M |
| MLM-MLM-3636 | 28L M/M |
| MLM-MLM-3645 | 28L x 35L M/M |
| MLM-MLM-3652 | 28L x 42L M/M |
| MLM-MLM-4545 | 35L M/M |
| MLM-MLM-5252 | 42L M/M |

Metric Heavy Male x Metric Heavy Female

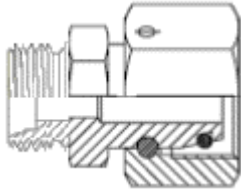

| | |
|--------------|---------------|
| MHM-MHF-1414 | 6S x 6S M/F |
| MHM-MHF-1416 | 6S x 8S M/F |
| MHM-MHF-1418 | 6S x 10S M/F |
| MHM-MHF-1420 | 6S x 12S M/F |
| MHM-MHF-1422 | 6S x 14S M/F |
| MHM-MHF-1424 | 6S x 16S M/F |
| MHM-MHF-1430 | 6S x 20S M/F |
| MHM-MHF-1436 | 6S x 25S M/F |
| MHM-MHF-1442 | 6S x 30S M/F |
| MHM-MHF-1452 | 6S x 38S M/F |
| MHM-MHF-1616 | 8S M/F |
| MHM-MHF-1618 | 8S x 10S M/F |
| MHM-MHF-1620 | 8S x 12S M/F |
| MHM-MHF-1622 | 8S x 14S M/F |
| MHM-MHF-1624 | 8S x 16S M/F |
| MHM-MHF-1630 | 8S x 20S M/F |
| MHM-MHF-1636 | 8S x 25S M/F |
| MHM-MHF-1642 | 8S x 30S M/F |
| MHM-MHF-1652 | 8S x 38S M/F |
| MHM-MHF-1818 | 10S M/F |
| MHM-MHF-1820 | 10S x 12S M/F |
| MHM-MHF-1822 | 10S x 14S M/F |
| MHM-MHF-1824 | 10S x 16S M/F |
| MHM-MHF-1830 | 10S x 20S M/F |
| MHM-MHF-1836 | 10S x 25S M/F |
| MHM-MHF-1842 | 10S x 30S M/F |
| MHM-MHF-1852 | 10S x 38S M/F |
| MHM-MHF-2020 | 12S M/F |
| MHM-MHF-2022 | 12S x 14S M/F |
| MHM-MHF-2024 | 12S x 16S M/F |
| MHM-MHF-2030 | 12S x 20S M/F |
| MHM-MHF-2036 | 12S x 25S M/F |
| MHM-MHF-2042 | 12S x 30S M/F |
| MHM-MHF-2052 | 12S x 38S M/F |
| MHM-MHF-2222 | 14S M/F |
| MHM-MHF-2224 | 14S x 16S M/F |
| MHM-MHF-2230 | 14S x 20S M/F |
| MHM-MHF-2236 | 14S x 25S M/F |
| MHM-MHF-2242 | 14S x 30S M/F |

| | |
|--------------|---------------|
| MHM-MHF-2252 | 14S x 38S M/F |
| MHM-MHF-2424 | 16S M/F |
| MHM-MHF-2430 | 16S x 20S M/F |
| MHM-MHF-2436 | 16S x 30S M/F |
| MHM-MHF-2442 | 16S x 25S M/F |
| MHM-MHF-2452 | 16S x 38S M/F |
| MHM-MHF-3030 | 20S M/F |
| MHM-MHF-3036 | 20S x 25S M/F |
| MHM-MHF-3042 | 20S x 30S M/F |
| MHM-MHF-3052 | 20S x 38S M/F |
| MHM-MHF-3636 | 25S M/F |
| MHM-MHF-3642 | 25S x 30S M/F |
| MHM-MHF-3652 | 25S x 38S M/F |
| MHM-MHF-4242 | 30S M/F |
| MHM-MHF-4252 | 30S x 38S M/F |
| MHM-MHF-5252 | 38S M/F |

Metric Light Male x Metric Light Female

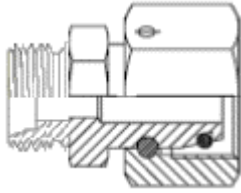

| | |
|--------------|---------------|
| MLM-MLF-1212 | 6L M/F |
| MLM-MLF-1214 | 6L x 8L M/F |
| MLM-MLF-1216 | 6L x 10L M/F |
| MLM-MLF-1218 | 6L x 12L M/F |
| MLM-MLF-1222 | 6L x 15L M/F |
| MLM-MLF-1226 | 6L x 18L M/F |
| MLM-MLF-1230 | 6L x 22L M/F |
| MLM-MLF-1236 | 6L x 28L M/F |
| MLM-MLF-1245 | 6L x 35L M/F |
| MLM-MLF-1252 | 6L x 42L M/F |
| MLM-MLF-1414 | 8LM/F |
| MLM-MLF-1416 | 8L x 10L M/F |
| MLM-MLF-1418 | 8L x 12L M/F |
| MLM-MLF-1422 | 8L x 15L M/F |
| MLM-MLF-1426 | 8L x 18L M/F |
| MLM-MLF-1430 | 8L x 22L M/F |
| MLM-MLF-1436 | 8L x 28L M/F |
| MLM-MLF-1445 | 8L x 35L M/F |
| MLM-MLF-1452 | 8L x 42L M/F |
| MLM-MLF-1616 | 10L M/F |
| MLM-MLF-1618 | 10L x 12L M/F |
| MLM-MLF-1622 | 10L x 15L M/F |
| MLM-MLF-1626 | 10L x 18L M/F |
| MLM-MLF-1630 | 10L x 22L M/F |
| MLM-MLF-1636 | 10L x 28L M/F |
| MLM-MLF-1645 | 10L x 35L M/F |
| MLM-MLF-1652 | 10L x 42L M/F |
| MLM-MLF-1818 | 12L M/F |
| MLM-MLF-1822 | 12L x 15L M/F |
| MLM-MLF-1826 | 12L x 18L M/F |
| MLM-MLF-1830 | 12L x 22L M/F |
| MLM-MLF-1836 | 12L x 28L M/F |
| MLM-MLF-1845 | 12L x 35L M/F |
| MLM-MLF-1852 | 12L x 42L M/F |
| MLM-MLF-2222 | 15L M/F |
| MLM-MLF-2226 | 15L x 18L M/F |
| MLM-MLF-2230 | 15L x 22L M/F |
| MLM-MLF-2236 | 15L x 28L M/F |
| MLM-MLF-2245 | 15L x 35L M/F |

| | |
|--------------|---------------|
| MLM-MLF-2252 | 15L x 42L M/F |
| MLM-MLF-2626 | 18L M/F |
| MLM-MLF-2630 | 18L x 22L M/F |
| MLM-MLF-2636 | 18L x 28L M/F |
| MLM-MLF-2645 | 18L x 35L M/F |
| MLM-MLF-2652 | 18L x 42L M/F |
| MLM-MLF-3030 | 22L M/F |
| MLM-MLF-3036 | 22L x 28L M/F |
| MLM-MLF-3045 | 22L x 35L M/F |
| MLM-MLF-3052 | 22L x 42L M/F |
| MLM-MLF-3636 | 28L M/F |
| MLM-MLF-3645 | 28L x 35L M/F |
| MLM-MLF-3652 | 28L x 42L M/F |
| MLM-MLF-4545 | 35L x 42L M/F |
| MLM-MLF-4552 | 35L x 42L M/F |
| MLM-MLF-5252 | 42L M/F |

Metric Male Stud x Metric Heavy Female

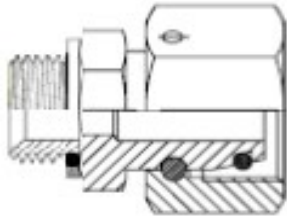

| | |
|--------------|---------------|
| MSM-MHF-1014 | M10 x 6S M/F |
| MSM-MHF-1214 | M12 x 6S M/F |
| MSM-MHF-1216 | M12 x 8S M/F |
| MSM-MHF-1416 | M14 x 8S M/F |
| MSM-MHF-1418 | M14 x 10S M/F |
| MSM-MHF-1420 | M14 x 12S M/F |
| MSM-MHF-1618 | M16 x 10S M/F |
| MSM-MHF-1620 | M16 x 12S M/F |
| MSM-MHF-1820 | M18 x 12S M/F |
| MSM-MHF-2022 | M20 x 14S M/F |
| MSM-MHF-2220 | M22 x 12S M/F |
| MSM-MHF-2224 | M22 x 16S M/F |
| MSM-MHF-2730 | M27 x 20S M/F |
| MSM-MHF-3336 | M33 x 25S M/F |
| MSM-MHF-4242 | M42 x 30S M/F |
| MSM-MHF-4852 | M48 x 38S M/F |

Metric Male Stud x Metric Light Female

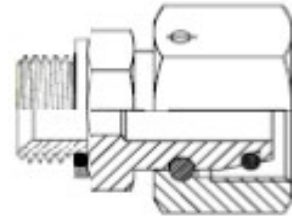

| | |
|--------------|---------------|
| MSM-MLF-1012 | M10 x 6L M/F |
| MSM-MLF-1212 | M12 x 6L M/F |
| MSM-MLF-1214 | M12 x 8L M/F |
| MSM-MLF-1414 | M14 x 8L M/F |
| MSM-MLF-1416 | M14 x 10L M/F |
| MSM-MLF-1418 | M14 x 12L M/F |
| MSM-MLF-1616 | M16 x 10L M/F |
| MSM-MLF-1618 | M16 x 12L M/F |
| MSM-MLF-1818 | M18 x 12L M/F |
| MSM-MLF-1822 | M18 x 15L M/F |
| MSM-MLF-2218 | M22 x 12L M/F |
| MSM-MLF-2222 | M22 X 15L M/F |
| MSM-MLF-2226 | M22 x 18L M/F |
| MSM-MLF-2626 | M26 x 18L M/F |
| MSM-MLF-2630 | M26 x 22L M/F |
| MSM-MLF-3336 | M33 x 28L M/F |
| MSM-MLF-4245 | M42 x 35L M/F |
| MSM-MLF-4852 | M48 x 42L M/F |

Metric Male Stud x Metric Heavy Male

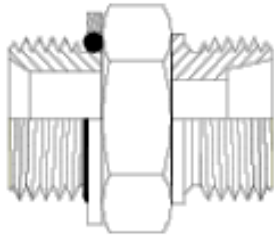

| | |
|--------------|---------------|
| MSM-MHM-1214 | M12 x 6S M/M |
| MSM-MHM-1416 | M14 x 8S M/M |
| MSM-MHM-1618 | M16 x 10S M/M |
| MSM-MHM-1820 | M18 x 12S M/M |
| MSM-MHM-1824 | M18 x 16S M/M |
| MSM-MHM-2022 | M20 x 14S M/M |
| MSM-MHM-2220 | M22 x 12S M/M |
| MSM-MHM-2224 | M22 x 16S M/M |
| MSM-MHM-2230 | M22 x 20S M/M |
| MSM-MHM-2730 | M27 x 20S M/M |
| MSM-MHM-2736 | M27 x 25S M/M |
| MSM-MHM-3336 | M33 x 25S M/M |
| MSM-MHM-3342 | M33 x 30S M/M |
| MSM-MHM-4242 | M42 x 30S M/M |
| MSM-MHM-4852 | M48 x 38S M/M |

Metric Male Stud x Metric Light Male

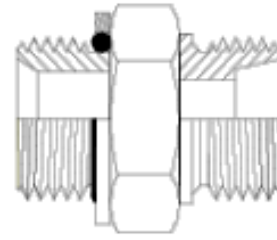

| | |
|--------------|---------------|
| MSM-MLM-1012 | M10 x 6L M/M |
| MSM-MLM-1014 | M10 x 8L M/M |
| MSM-MLM-1212 | M12 x 6L M/M |
| MSM-MLM-1214 | M12 x 8L M/M |
| MSM-MLM-1414 | M14 x 8L M/M |
| MSM-MLM-1416 | M14 x 10L M/M |
| MSM-MLM-1418 | M14 x 12L M/M |
| MSM-MLM-1616 | M16 x 10L M/M |
| MSM-MLM-1618 | M16 x 12L M/M |
| MSM-MLM-1622 | M16 x 15L M/M |
| MSM-MLM-1814 | M18 x 8L M/M |
| MSM-MLM-1816 | M18 x 10L M/M |
| MSM-MLM-1818 | M18 x 12L M/M |
| MSM-MLM-1822 | M18 x 15L M/M |
| MSM-MLM-1826 | M18 x 18L M/M |
| MSM-MLM-2214 | M22 x 8L M/M |
| MSM-MLM-2216 | M22 x 10L M/M |
| MSM-MLM-2218 | M22 x 12L M/M |
| MSM-MLM-2222 | M22 x 15L M/M |
| MSM-MLM-2226 | M22 x 18L M/M |
| MSM-MLM-2230 | M22 x 22L M/M |
| MSM-MLM-2630 | M26 x 22L M/M |
| MSM-MLM-3336 | M33 x 28L M/M |
| MSM-MLM-4245 | M42 x 35L M/M |
| MSM-MLM-4852 | M48 x 42L M/M |

Metric Heavy Male x UNO Male

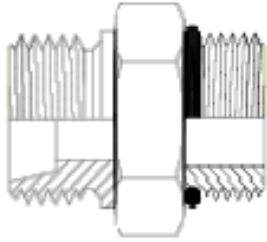

| | |
|--------------|---------------------|
| MHM-UNM-1407 | 6S M x 7/16 UNOM |
| MHM-UNM-1409 | 6S M x 9/16 UNOM |
| MHM-UNM-1607 | 8S M x 7/16 UNOM |
| MHM-UNM-1609 | 8S M x 9/16 UNOM |
| MHM-UNM-1809 | 10S M x 9/16 UNOM |
| MHM-UNM-1812 | 10S M x 3/4 UNOM |
| MHM-UNM-2007 | 12S M x 7/16 UNOM |
| MHM-UNM-2009 | 12S M x 9/16 UNOM |
| MHM-UNM-2012 | 12S M x 3/4 UNOM |
| MHM-UNM-2014 | 12S M x 7/8 UNOM |
| MHM-UNM-2017 | 12S M x 1-1/16 UNOM |
| MHM-UNM-2212 | 14S M x 3/4 UNOM |
| MHM-UNM-2412 | 16S M x 3/4 UNOM |
| MHM-UNM-2414 | 16S M x 7/8 UNOM |
| MHM-UNM-2417 | 16S M x 1-1/16 UNOM |
| MHM-UNM-3012 | 20S M x 3/4 UNOM |
| MHM-UNM-3014 | 16S M x 7/8 UNOM |
| MHM-UNM-3017 | 20S M x 1-1/16 UNOM |
| MHM-UNM-3617 | 25S M x 1-1/16 UNOM |
| MHM-UNM-3621 | 25S M x 1-5/16 UNOM |
| MHM-UNM-4221 | 30S M x 1-5/16 UNOM |
| MHM-UNM-4226 | 30S M x 1-5/8 UNOM |
| MHM-UNM-5226 | 38S M x 1-5/8 UNOM |
| MHM-UNM-5230 | 38S M x 1-7/8 UNOM |

Metric Light Male x UNO Male

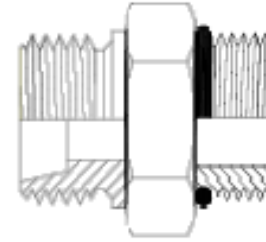

| | |
|--------------|----------------------|
| MLM-UNM-1207 | 6L x 7/16 UNO M/M |
| MLM-UNM-1407 | 8L x 7/16 UNO M/M |
| MLM-UNM-1409 | 8L x 9/16 UNO M/M |
| MLM-UNM-1412 | 8L x 3/4 UNO M/M |
| MLM-UNM-1607 | 10L x 7/16 UNO M/M |
| MLM-UNM-1609 | 10L x 9/16 UNO M/M |
| MLM-UNM-1612 | 10L x 3/4 UNO M/M |
| MLM-UNM-1614 | 10L x 7/8 UNO M/M |
| MLM-UNM-1809 | 12L x 9/16 UNO M/M |
| MLM-UNM-1812 | 12L x 3/4 UNO M/M |
| MLM-UNM-1814 | 12L x 7/8 UNO M/M |
| MLM-UNM-2212 | 15L x 3/4 UNO M/M |
| MLM-UNM-2214 | 15L x 7/8 UNO M/M |
| MLM-UNM-2217 | 15L x 1-1/16 UNO M/M |
| MLM-UNM-2612 | 18L x 3/4 UNO M/M |
| MLM-UNM-2614 | 18L x 7/8 UNO M/M |
| MLM-UNM-3014 | 22L x 7/8 UNO M/M |
| MLM-UNM-3017 | 22L x 1-1/16 UNO M/M |
| MLM-UNM-3021 | 22L x 1-5/16 UNO M/M |
| MLM-UNM-3617 | 28L x 1-1/16 UNO M/M |
| MLM-UNM-3621 | 28L x 1-5/16 UNO M/M |
| MLM-UNM-4521 | 35L x 1-5/16 UNO M/M |
| MLM-UNM-4526 | 35L x 1-5/8 UNO M/M |
| MLM-UNM-5226 | 42L x 1-5/8 UNO M/M |
| MLM-UNM-5230 | 42L x 1-7/8 UNO M/M |

NPT Male x Metric Heavy Male

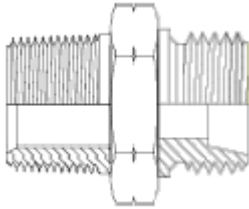

NPT Male x Metric Light Male

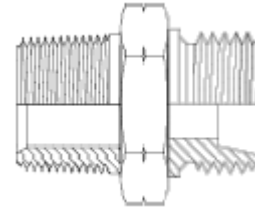

| | |
|--------------|--------------------|
| NTM-MHM-0414 | 1/4 NPTM x 6S M |
| NTM-MHM-0416 | 1/4 NPTM x 8S M |
| NTM-MHM-0618 | 3/8 NPTM x 10S M |
| NTM-MHM-0620 | 3/8 NPTM x 12S M |
| NTM-MHM-0622 | 3/8 NPTM x 14S M |
| NTM-MHM-0624 | 3/8 NPTM x 16S M |
| NTM-MHM-0820 | 1/2 NPTM x 12S M |
| NTM-MHM-0822 | 1/2 NPTM x 14S M |
| NTM-MHM-0824 | 1/2 NPTM x 16S M |
| NTM-MHM-0830 | 1/2 NPTM x 20S M |
| NTM-MHM-1230 | 3/4 NPTM x 20S M |
| NTM-MHM-1236 | 3/4 NPTM x 25S M |
| NTM-MHM-1636 | 1 NPTM x 25S M |
| NTM-MHM-1642 | 1 NPTM x 30S M |
| NTM-MHM-2042 | 1-1/4 NPTM x 30S M |
| NTM-MHM-2452 | 1-1/2 NPTM x 38S M |

| | |
|--------------|--------------------|
| NTM-MLM-0212 | 1/8 NPTM x 6L M |
| NTM-MLM-0214 | 1/8 NPTM x 8L M |
| NTM-MLM-0412 | 1/4 NPTM x 6L M |
| NTM-MLM-0414 | 1/4 NPTM x 8L M |
| NTM-MLM-0416 | 1/4 NPTM x 10L M |
| NTM-MLM-0418 | 1/4 NPTM x 12L M |
| NTM-MLM-0614 | 3/8 NPTM x 8L M |
| NTM-MLM-0616 | 3/8 NPTM x 10L M |
| NTM-MLM-0618 | 3/8 NPTM x 12L M |
| NTM-MLM-0622 | 3/8 NPTM x 15L M |
| NTM-MLM-0816 | 1/2 NPTM x 10L M |
| NTM-MLM-0818 | 1/2 NPTM x 12L M |
| NTM-MLM-0822 | 1/2 NPTM x 15L M |
| NTM-MLM-0826 | 1/2 NPTM x 18L M |
| NTM-MLM-1226 | 3/4 NPTM x 18L M |
| NTM-MLM-1230 | 3/4 NPTM x 22L M |
| NTM-MLM-1636 | 1 NPTM x 28L M |
| NTM-MLM-2045 | 1-1/4 NPTM x 35L M |
| NTM-MLM-2452 | 1-1/2 NPTM x 42L M |

Bulkhead

Metric Heavy Male Bulkhead

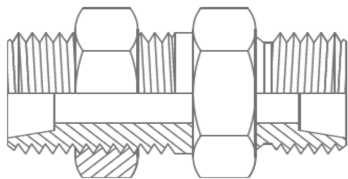

| | |
|--------------|--------------|
| MHM-MBM-1414 | 6S Bulkhead |
| MHM-MBM-1616 | 8S Bulkhead |
| MHM-MBM-1818 | 10S Bulkhead |
| MHM-MBM-2020 | 12S Bulkhead |
| MHM-MBM-2222 | 14S Bulkhead |
| MHM-MBM-2424 | 16S Bulkhead |
| MHM-MBM-3030 | 20S Bulkhead |
| MHM-MBM-3636 | 25S Bulkhead |
| MHM-MBM-4242 | 30S Bulkhead |
| MHM-MBM-5252 | 38S Bulkhead |

Metric Light Male Bulkhead

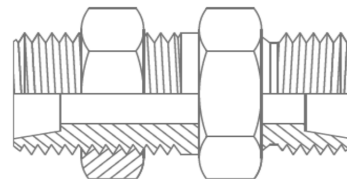

| | |
|--------------|--------------|
| MLM-MBM-1212 | 6L Bulkhead |
| MLM-MBM-1414 | 8L Bulkhead |
| MLM-MBM-1616 | 10L Bulkhead |
| MLM-MBM-1818 | 12L Bulkhead |
| MLM-MBM-2222 | 15L Bulkhead |
| MLM-MBM-2626 | 18L Bulkhead |
| MLM-MBM-3030 | 22L Bulkhead |
| MLM-MBM-3636 | 28L Bulkhead |
| MLM-MBM-4545 | 35L Bulkhead |
| MLM-MBM-5252 | 42L Bulkhead |

Metric Heavy Male Bulkhead 90 Degree

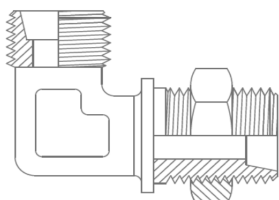

| | |
|------------------|------------------|
| MHM-MBM-90C-1414 | 6S Bulkhead 90° |
| MHM-MBM-90C-1616 | 8S Bulkhead 90° |
| MHM-MBM-90C-1818 | 10S Bulkhead 90° |
| MHM-MBM-90C-2020 | 12S Bulkhead 90° |
| MHM-MBM-90C-2222 | 14S Bulkhead 90° |
| MHM-MBM-90C-2424 | 16S Bulkhead 90° |
| MHM-MBM-90C-3030 | 20S Bulkhead 90° |
| MHM-MBM-90C-3636 | 25S Bulkhead 90° |
| MHM-MBM-90C-4242 | 30S Bulkhead 90° |
| MHM-MBM-90C-5252 | 38S Bulkhead 90° |

Metric Light Male Bulkhead 90 Degree

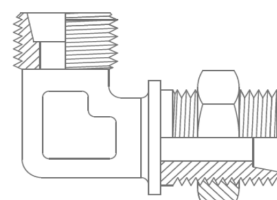

| | |
|------------------|------------------|
| MLM-MBM-90C-1212 | 6L Bulkhead 90° |
| MLM-MBM-90C-1414 | 8L Bulkhead 90° |
| MLM-MBM-90C-1616 | 10L Bulkhead 90° |
| MLM-MBM-90C-1818 | 12L Bulkhead 90° |
| MLM-MBM-90C-2222 | 15L Bulkhead 90° |
| MLM-MBM-90C-2626 | 18L Bulkhead 90° |
| MLM-MBM-90C-3030 | 22L Bulkhead 90° |
| MLM-MBM-90C-3636 | 28L Bulkhead 90° |
| MLM-MBM-90C-4545 | 35L Bulkhead 90° |
| MLM-MBM-90C-5252 | 42L Bulkhead 90° |

90 Degree

BSPM Male x Metric Heavy Male 90 Degree

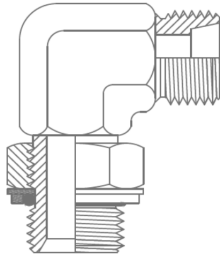

| | |
|------------------|-------------------------|
| BPM-MHM-90C-0414 | 1/4 BSPPM x 6S M 90° |
| BPM-MHM-90C-0416 | 1/4 BSPPM x 8S M 90° |
| BPM-MHM-90C-0616 | 3/8 BSPPM x 8S M 90° |
| BPM-MHM-90C-0618 | 3/8 BSPPM x 10S M 90° |
| BPM-MHM-90C-0620 | 3/8 BSPPM x 12S M 90° |
| BPM-MHM-90C-0820 | 1/2 BSPPM x 12S M 90° |
| BPM-MHM-90C-0822 | 1/2 BSPPM x 14S M 90° |
| BPM-MHM-90C-0824 | 1/2 BSPPM x 16S M 90° |
| BPM-MHM-90C-1230 | 3/4 BSPPM x 20S M 90° |
| BPM-MHM-90C-1236 | 3/4 BSPPM x 25S M 90° |
| BPM-MHM-90C-1636 | 1 BSPPM x 25S M 90° |
| BPM-MHM-90C-1642 | 1 BSPPM x 30S M 90° |
| BPM-MHM-90C-2042 | 1-1/4 BSPPM x 30S M 90° |
| BPM-MHM-90C-2452 | 1-1/2 BSPPM x 38S M 90° |

BSPM Male x Metric Light Male 90 Degree

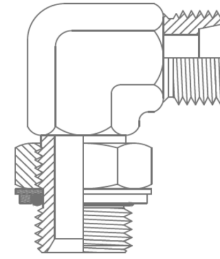

| | |
|------------------|-------------------------|
| BPM-MLM-90C-0212 | 1/8 BSPPM x 6L M 90° |
| BPM-MLM-90C-0414 | 1/4 BSPPM x 8L M 90° |
| BPM-MLM-90C-0416 | 1/4 BSPPM x 10L M 90° |
| BPM-MLM-90C-0418 | 1/4 BSPPM x 12L M 90° |
| BPM-MLM-90C-0614 | 3/8 BSPPM x 8L M 90° |
| BPM-MLM-90C-0616 | 3/8 BSPPM x 10L M 90° |
| BPM-MLM-90C-0618 | 3/8 BSPPM x 12L M 90° |
| BPM-MLM-90C-0622 | 3/8 BSPPM x 15L M 90° |
| BPM-MLM-90C-0816 | 1/2 BSPPM x 10L M 90° |
| BPM-MLM-90C-0818 | 1/2 BSPPM x 12L M 90° |
| BPM-MLM-90C-0822 | 1/2 BSPPM x 15L M 90° |
| BPM-MLM-90C-0826 | 1/2 BSPPM x 18L M 90° |
| BPM-MLM-90C-1222 | 3/4 BSPPM x 15L M 90° |
| BPM-MLM-90C-1226 | 3/4 BSPPM x 18L M 90° |
| BPM-MLM-90C-1230 | 3/4 BSPPM x 22L M 90° |
| BPM-MLM-90C-1630 | 1 BSPPM x 22L M 90° |
| BPM-MLM-90C-1636 | 1 BSPPM x 28L M 90° |
| BPM-MLM-90C-2036 | 1-1/4 BSPPM x 28L M 90° |
| BPM-MLM-90C-2045 | 1-1/4 BSPPM x 35L M 90° |
| BPM-MLM-90C-2452 | 1-1/2 BSPPM x 42L M 90° |

BSPT Male x Metric Heavy Male 90 Degree

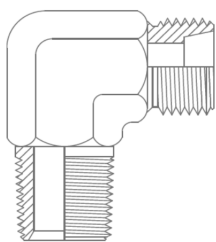

| | |
|------------------|-------------------------|
| BTM-MHM-90C-0414 | 1/4 BSPTM x 6S M 90° |
| BTM-MHM-90C-0416 | 1/4 BSPTM x 8S M 90° |
| BTM-MHM-90C-0618 | 3/8 BSPTM x 10S M 90° |
| BTM-MHM-90C-0620 | 3/8 BSPTM x 12S M 90° |
| BTM-MHM-90C-0622 | 3/8 BSPTM x 14S M 90° |
| BTM-MHM-90C-0624 | 3/8 BSPTM x 16S M 90° |
| BTM-MHM-90C-0820 | 1/2 BSPTM x 12S M 90° |
| BTM-MHM-90C-0822 | 1/2 BSPTM x 14S M 90° |
| BTM-MHM-90C-0824 | 1/2 BSPTM x 16S M 90° |
| BTM-MHM-90C-0830 | 1/2 BSPTM x 20S M 90° |
| BTM-MHM-90C-1230 | 3/4 BSPTM x 20S M 90° |
| BTM-MHM-90C-1236 | 3/4 BSPTM x 25S M 90° |
| BTM-MHM-90C-1636 | 1 BSPTM x 25S M 90° |
| BTM-MHM-90C-1642 | 1 BSPTM x 30S M 90° |
| BTM-MHM-90C-2042 | 1-1/4 BSPTM x 30S M 90° |
| BTM-MHM-90C-2452 | 1-1/2 BSPTM x 38S M 90° |

BSPT Male x Metric Light Male 90 Degree

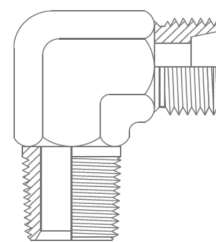

| | |
|-------------------|-------------------------|
| BTM-MLLM-90C-0210 | 1/8 BSPTM x 6LL M 90° |
| BTM-MLM-90C-0212 | 1/8 BSPTM x 6L M 90° |
| BTM-MLM-90C-0214 | 1/8 BSPTM x 8L M 90° |
| BTM-MLM-90C-0216 | 1/8 BSPTM x 10L M 90° |
| BTM-MLM-90C-0412 | 1/4 BSPTM x 6L M 90° |
| BTM-MLM-90C-0414 | 1/4 BSPTM x 8L M 90° |
| BTM-MLM-90C-0416 | 1/4 BSPTM x 10L M 90° |
| BTM-MLM-90C-0418 | 1/4 BSPTM x 12L M 90° |
| BTM-MLM-90C-0614 | 3/8 BSPTM x 8L M 90° |
| BTM-MLM-90C-0616 | 3/8 BSPTM x 10L M 90° |
| BTM-MLM-90C-0618 | 3/8 BSPTM x 12L M 90° |
| BTM-MLM-90C-0622 | 3/8 BSPTM x 15L M 90° |
| BTM-MLM-90C-0814 | 1/2 BSPTM x 8L M 90° |
| BTM-MLM-90C-0816 | 1/2 BSPTM x 10L M 90° |
| BTM-MLM-90C-0818 | 1/2 BSPTM x 12L M 90° |
| BTM-MLM-90C-0822 | 1/2 BSPTM x 15L M 90° |
| BTM-MLM-90C-0826 | 1/2 BSPTM x 18L M 90° |
| BTM-MLM-90C-1226 | 3/4 BSPTM x 18LM 90° |
| BTM-MLM-90C-1230 | 3/4 BSPTM x 22L M 90° |
| BTM-MLM-90C-1636 | 1 BSPTM x 28L M 90° |
| BTM-MLM-90C-2045 | 1-1/4 BSPTM x 35L M 90° |
| BTM-MLM-90C-2452 | 1-1/2 BSPTM x 42L M 90° |

Metric Heavy Male x Metric Heavy Female 90 Degree

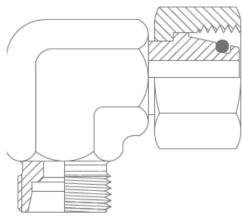

| | |
|------------------|-------------|
| MHM-MHF-90C-1414 | 6S M/F 90° |
| MHM-MHF-90C-1616 | 8S M/F 90° |
| MHM-MHF-90C-1818 | 10S M/F 90° |
| MHM-MHF-90C-2020 | 12S M/F 90° |
| MHM-MHF-90C-2222 | 14S M/F 90° |
| MHM-MHF-90C-2424 | 16S M/F 90° |
| MHM-MHF-90C-3030 | 20S M/F 90° |
| MHM-MHF-90C-3636 | 25S M/F 90° |
| MHM-MHF-90C-4242 | 30S M/F 90° |
| MHM-MHF-90C-5252 | 38S M/F 90° |

Metric Light Male x Metric Light Female Swivel 90 Degree

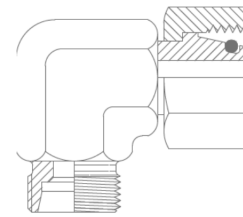

| | |
|------------------|-------------|
| MLM-MLF-90C-1212 | 6L M/F 90° |
| MLM-MLF-90C-1414 | 8L M/F 90° |
| MLM-MLF-90C-1616 | 10L M/F 90° |
| MLM-MLF-90C-1818 | 12L M/F 90° |
| MLM-MLF-90C-2222 | 15L M/F 90° |
| MLM-MLF-90C-2626 | 18L M/F 90° |
| MLM-MLF-90C-3030 | 22L M/F 90° |
| MLM-MLF-90C-3636 | 28L M/F 90° |
| MLM-MLF-90C-4545 | 35L M/F 90° |
| MLM-MLF-90C-5252 | 42L M/F 90° |

Metric Heavy Male x Metric Heavy Male 90 Degree

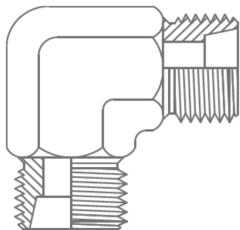

| | |
|------------------|-------------|
| MHM-MHM-90C-1414 | 6S M/M 90° |
| MHM-MHM-90C-1616 | 8S M/M 90° |
| MHM-MHM-90C-1818 | 10S M/M 90° |
| MHM-MHM-90C-2020 | 12S M/M 90° |
| MHM-MHM-90C-2222 | 14S M/M 90° |
| MHM-MHM-90C-2424 | 16S M/M 90° |
| MHM-MHM-90C-3030 | 20S M/M 90° |
| MHM-MHM-90C-3636 | 25S M/M 90° |
| MHM-MHM-90C-4242 | 30S M/M 90° |
| MHM-MHM-90C-5252 | 38S M/M 90° |

Metric Light Male x Metric Light Male 90 Degree

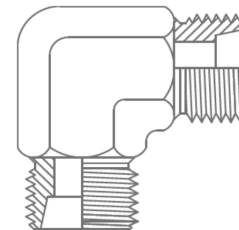

| | |
|------------------|-------------|
| MLM-MLM-90C-1212 | 6L M/M 90° |
| MLM-MLM-90C-1414 | 8L M/M 90° |
| MLM-MLM-90C-1616 | 10L M/M 90° |
| MLM-MLM-90C-1818 | 12L M/M 90° |
| MLM-MLM-90C-2222 | 15L M/M 90° |
| MLM-MLM-90C-2626 | 18L M/M 90° |
| MLM-MLM-90C-3030 | 22L M/M 90° |
| MLM-MLM-90C-3636 | 28L M/M 90° |
| MLM-MLM-90C-4545 | 35L M/M 90° |
| MLM-MLM-90C-5252 | 42L M/M 90° |

NPT Male x Metric Heavy Male 90 Degree

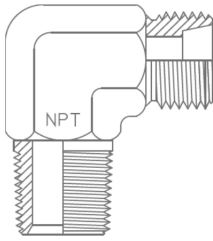

| | |
|------------------|------------------------|
| NTM-MHM-90C-0414 | 1/4 NPTM x 6S M 90° |
| NTM-MHM-90C-0416 | 1/4 NPTM x 8S M 90° |
| NTM-MHM-90C-0618 | 3/8 NPTM x 10S M 90° |
| NTM-MHM-90C-0620 | 3/8 NPTM x 12S M 90° |
| NTM-MHM-90C-0622 | 3/8 NPTM x 14S M 90° |
| NTM-MHM-90C-0624 | 3/8 NPTM x 16S M 90° |
| NTM-MHM-90C-0820 | 1/2 NPTM x 12S M 90° |
| NTM-MHM-90C-0822 | 1/2 NPTM x 14S M 90° |
| NTM-MHM-90C-0824 | 1/2 NPTM x 16S M 90° |
| NTM-MHM-90C-0830 | 1/2 NPTM x 20S M 90° |
| NTM-MHM-90C-1230 | 3/4 NPTM x 20S M 90° |
| NTM-MHM-90C-1236 | 3/4 NPTM x 25S M 90° |
| NTM-MHM-90C-1636 | 1 NPTM x 25S M 90° |
| NTM-MHM-90C-1642 | 1 NPTM x 30S M 90° |
| NTM-MHM-90C-2042 | 1-1/4 NPTM x 30S M 90° |
| NTM-MHM-90C-2452 | 1-1/2 NPTM x 38S M 90° |

NPT Male x Metric Light Male 90 Degree

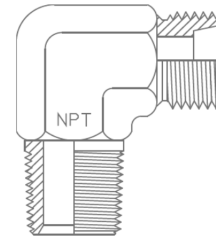

| | |
|------------------|------------------------|
| NTM-MLM-90C-0212 | 1/8 NPTM x 6L M 90° |
| NTM-MLM-90C-0214 | 1/8 NPTM x 8L M 90° |
| NTM-MLM-90C-0216 | 1/8 NPTM x 10L M 90° |
| NTM-MLM-90C-0412 | 1/4 NPTM x 6L M 90° |
| NTM-MLM-90C-0414 | 1/4 NPTM x 8L M 90° |
| NTM-MLM-90C-0416 | 1/4 NPTM x 10L M 90° |
| NTM-MLM-90C-0418 | 1/4 NPTM x 12L M 90° |
| NTM-MLM-90C-0614 | 3/8 NPTM x 8L M 90° |
| NTM-MLM-90C-0616 | 3/8 NPTM x 10L M 90° |
| NTM-MLM-90C-0618 | 3/8 NPTM x 12L M 90° |
| NTM-MLM-90C-0622 | 3/8 NPTM x 15L M 90° |
| NTM-MLM-90C-0814 | 1/2 NPTM x 8L M 90° |
| NTM-MLM-90C-0816 | 1/2 NPTM x 10L M 90° |
| NTM-MLM-90C-0818 | 1/2 NPTM x 12L M 90° |
| NTM-MLM-90C-0822 | 1/2 NPTM x 15L M 90° |
| NTM-MLM-90C-0826 | 1/2 NPTM x 18L M 90° |
| NTM-MLM-90C-1226 | 3/4 NPTM x 18L M 90° |
| NTM-MLM-90C-1230 | 3/4 NPTM x 22L M 90° |
| NTM-MLM-90C-1636 | 1 NPTM x 28L M 90° |
| NTM-MLM-90C-2045 | 1-1/4 NPTM x 35L M 90° |
| NTM-MLM-90C-2452 | 1-1/2 NPTM x 42L M 90° |

Tee

Metric Heavy Male / Metric Heavy Female Swivel Run Tee

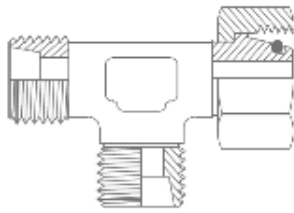

| | |
|--------------------|-------------|
| MHM-MHF-MHM-141414 | 6S Run Tee |
| MHM-MHF-MHM-161616 | 8S Run Tee |
| MHM-MHF-MHM-181818 | 10S Run Tee |
| MHM-MHF-MHM-202020 | 12S Run Tee |
| MHM-MHF-MHM-222222 | 14S Run Tee |
| MHM-MHF-MHM-242424 | 16S Run Tee |
| MHM-MHF-MHM-303030 | 20S Run Tee |
| MHM-MHF-MHM-363636 | 25S Run Tee |
| MHM-MHF-MHM-424242 | 30S Run Tee |
| MHM-MHF-MHM-525252 | 38S Run Tee |

Metric Light Male / Metric Light Female Swivel Run Tee

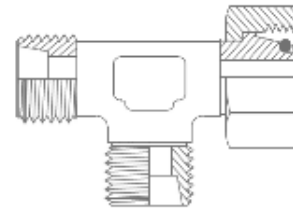

| | |
|--------------------|-------------|
| MLM-MLF-MLM-121212 | 6L Run Tee |
| MLM-MLF-MLM-141414 | 8L Run Tee |
| MLM-MLF-MLM-161616 | 10L Run Tee |
| MLM-MLF-MLM-181818 | 12L Run Tee |
| MLM-MLF-MLM-222222 | 15L Run Tee |
| MLM-MLF-MLM-262626 | 18L Run Tee |
| MLM-MLF-MLM-303030 | 22L Run Tee |
| MLM-MLF-MLM-363636 | 28L Run Tee |
| MLM-MLF-MLM-454545 | 35L Run Tee |
| MLM-MLF-MLM-525252 | 42L Run Tee |

Metric Heavy Male / Metric Heavy Female Swivel Branch Tee

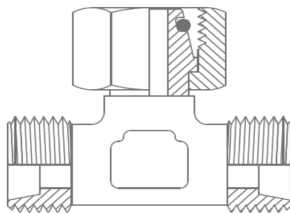

| | |
|--------------------|----------------|
| MHM-MHM-MHF-141414 | 6S Branch Tee |
| MHM-MHM-MHF-161616 | 8S Branch Tee |
| MHM-MHM-MHF-181818 | 10S Branch Tee |
| MHM-MHM-MHF-202020 | 12S Branch Tee |
| MHM-MHM-MHF-222222 | 14S Branch Tee |
| MHM-MHM-MHF-242424 | 16S Branch Tee |
| MHM-MHM-MHF-303030 | 20S Branch Tee |
| MHM-MHM-MHF-363636 | 25S Branch Tee |
| MHM-MHM-MHF-424242 | 30S Branch Tee |
| MHM-MHM-MHF-525252 | 38S Branch Tee |

Metric Light Male / Metric Light Female Swivel Branch Tee

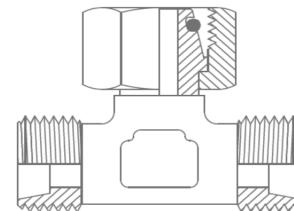

| | |
|--------------------|----------------|
| MLM-MLM-MLF-121212 | 6L Branch Tee |
| MLM-MLM-MLF-141414 | 8L Branch Tee |
| MLM-MLM-MLF-161616 | 10L Branch Tee |
| MLM-MLM-MLF-181818 | 12L Branch Tee |
| MLM-MLM-MLF-222222 | 15L Branch Tee |
| MLM-MLM-MLF-262626 | 18L Branch Tee |
| MLM-MLM-MLF-303030 | 22L Branch Tee |
| MLM-MLM-MLF-363636 | 28L Branch Tee |
| MLM-MLM-MLF-454545 | 35L Branch Tee |
| MLM-MLM-MLF-525252 | 42L Branch Tee |

Metric Heavy Male Tee

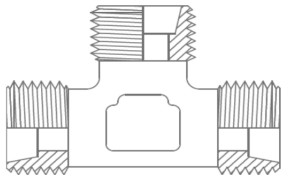

| | |
|--------------------|--------------|
| MHM-MHM-MHM-141414 | 6S Male Tee |
| MHM-MHM-MHM-161616 | 8S Male Tee |
| MHM-MHM-MHM-181818 | 10S Male Tee |
| MHM-MHM-MHM-202020 | 12S Male Tee |
| MHM-MHM-MHM-222222 | 14S Male Tee |
| MHM-MHM-MHM-242424 | 16S Male Tee |
| MHM-MHM-MHM-303030 | 20S Male Tee |
| MHM-MHM-MHM-363636 | 25S Male Tee |
| MHM-MHM-MHM-424242 | 30S Male Tee |
| MHM-MHM-MHM-525252 | 38S Male Tee |

Metric Light Male Tee

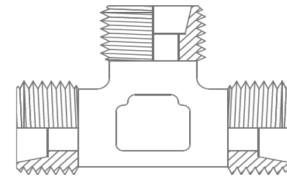

| | |
|--------------------|--------------|
| MLM-MLM-MLM-121212 | 6L Male Tee |
| MLM-MLM-MLM-141414 | 8L Male Tee |
| MLM-MLM-MLM-161616 | 10L Male Tee |
| MLM-MLM-MLM-181818 | 12L Male Tee |
| MLM-MLM-MLM-222222 | 15L Male Tee |
| MLM-MLM-MLM-262626 | 18L Male Tee |
| MLM-MLM-MLM-303030 | 22L Male Tee |
| MLM-MLM-MLM-363636 | 28L Male Tee |
| MLM-MLM-MLM-454545 | 35L Male Tee |
| MLM-MLM-MLM-525252 | 42L Male Tee |

Caps & Plugs

Metric Heavy Cap

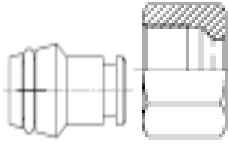

| | |
|--------|---------|
| MHF-14 | 6S Cap |
| MHF-16 | 8S Cap |
| MHF-18 | 10S Cap |
| MHF-20 | 12S Cap |
| MHF-22 | 14S Cap |
| MHF-24 | 16S Cap |
| MHF-30 | 20S Cap |
| MHF-36 | 25S Cap |
| MHF-42 | 30S Cap |
| MHF-52 | 38S Cap |

Metric Light Cap

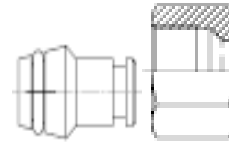

| | |
|--------|---------|
| MLF-12 | 6L Cap |
| MLF-14 | 8L Cap |
| MLF-16 | 10L Cap |
| MLF-18 | 12L Cap |
| MLF-22 | 15L Cap |
| MLF-26 | 18L Cap |
| MLF-30 | 22L Cap |
| MLF-36 | 28L Cap |
| MLF-45 | 35L Cap |
| MLF-52 | 42L Cap |

Metric Heavy Plug



| | |
|--------|-------------------|
| MHM-14 | 6S Threaded Plug |
| MHM-16 | 8S Threaded Plug |
| MHM-18 | 10S Threaded Plug |
| MHM-20 | 12S Threaded Plug |
| MHM-22 | 14S Threaded Plug |
| MHM-24 | 16S Threaded Plug |
| MHM-30 | 20S Threaded Plug |
| MHM-36 | 25S Threaded Plug |
| MHM-42 | 30S Threaded Plug |
| MHM-52 | 38S Threaded Plug |

Metric Light Plug



| | |
|--------|-------------------|
| MLM-12 | 6L Threaded Plug |
| MLM-14 | 8L Threaded Plug |
| MLM-16 | 10L Threaded Plug |
| MLM-18 | 12L Threaded Plug |
| MLM-22 | 15L Threaded Plug |
| MLM-26 | 18L Threaded Plug |
| MLM-30 | 22L Threaded Plug |
| MLM-36 | 28L Threaded Plug |
| MLM-45 | 35L Threaded Plug |
| MLM-52 | 42L Threaded Plug |

Associated Items

Metric Heavy Compression Nut



| | |
|--------|---------|
| MHN-14 | 6S Nut |
| MHN-16 | 8S Nut |
| MHN-18 | 10S Nut |
| MHN-20 | 12S Nut |
| MHN-22 | 14S Nut |
| MHN-24 | 16S Nut |
| MHN-30 | 20S Nut |
| MHN-36 | 25S Nut |
| MHN-42 | 30S Nut |
| MHN-52 | 38S Nut |

Metric Light Compression Nut



| | |
|---------|---------|
| MLLN-10 | 6LL Nut |
| MLN-12 | 6L Nut |
| MLN-14 | 8L Nut |
| MLN-16 | 10L Nut |
| MLN-18 | 12L Nut |
| MLN-22 | 15L Nut |
| MLN-26 | 18L Nut |
| MLN-30 | 22L Nut |
| MLN-36 | 28L Nut |
| MLN-45 | 35L Nut |
| MLN-52 | 42L Nut |

Metric Cutting Ring

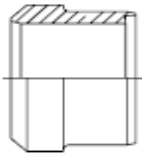

| | |
|-----------|----------------------------------|
| MCS-06LL | 6mm Cutting Sleeve (Extra Light) |
| MCS-06L/S | 6mm Cutting Sleeve |
| MCS-08L/S | 8mm Cutting Sleeve |
| MCS-10L/S | 10mm Cutting Sleeve |
| MCS-12L/S | 12mm Cutting Sleeve |
| MCS-14S | 14mm Cutting Sleeve |
| MCS-15L | 15mm Cutting Sleeve |
| MCS-16S | 16mm Cutting Sleeve |
| MCS-18L | 18mm Cutting Sleeve |
| MCS-20S | 20mm Cutting Sleeve |
| MCS-22L | 22mm Cutting Sleeve |
| MCS-25S | 25mm Cutting Sleeve |
| MCS-28L | 28mm Cutting Sleeve |
| MCS-30S | 30mm Cutting Sleeve |
| MCS-35L | 35mm Cutting Sleeve |
| MCS-38S | 38mm Cutting Sleeve |
| MCS-42L | 42mm Cutting Sleeve |

The background features a technical drawing of two hose assemblies. Each assembly consists of a hose tail with a braided reinforcement section and a ferrule. The drawing uses solid lines for visible edges and dashed lines for hidden internal features, all rendered in a light green color against a dark green background. The text is centered over the drawing.

HOSETAILS & FERRULES

Low Pressure Hosetails Straight

BSPP Male to Low Pressure Hosetail

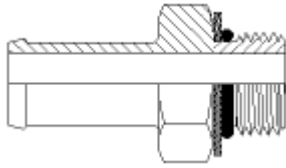

| | |
|--------------|--------------------------|
| LPT-BPM-1212 | 3/4 Tail x 3/4 BSPPM |
| LPT-BPM-1612 | 1 Tail x 3/4 BSPPM |
| LPT-BPM-1616 | 1 Tail x 3/4 BSPPM |
| LPT-BPM-2012 | 1-1/4 Tail x 3/4 BSPPM |
| LPT-BPM-2016 | 1-1/4 Tail x 1 BSPPM |
| LPT-BPM-2020 | 1-1/4 Tail x 1-1/4 BSPPM |
| LPT-BPM-2416 | 1-1/2 Tail x 1 BSPPM |
| LPT-BPM-2420 | 1-1/2 Tail x 1-1/4 BSPPM |
| LPT-BPM-2424 | 1-1/2 Tail x 1-1/2 BSPPM |

BSPP Female to Low Pressure Hosetail

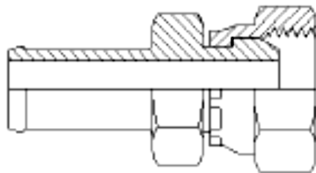

| | |
|--------------|---------------------------|
| LPT-BSF-1212 | 3/4 Tail x 3/4 BSPPFS |
| LPT-BSF-1616 | 1 Tail x 1 BSPPFS |
| LPT-BSF-2020 | 1-1/4 Tail x 1-1/4 BSPPFS |
| LPT-BSF-2424 | 1-1/2 Tail x 1-1/2 BSPPFS |

JIC Female to Low Pressure Hosetail

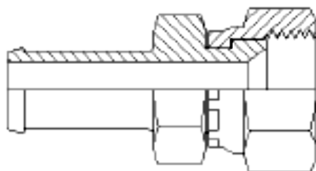

| | |
|--------------|--------------------------|
| LPT-JIF-1617 | 1 Tail x 1-1/16 JICFS |
| LPT-JIF-2026 | 1-1/4 Tail x 1-5/8 JICFS |

BSPT Male to Low Pressure Hosetail

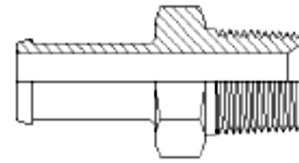

| | |
|--------------|--------------------------|
| LPT-BTM-0808 | 1/2 Tail x 1/2 BSPTM |
| LPT-BTM-1208 | 3/4 Tail x 1/2 BSPTM |
| LPT-BTM-1212 | 3/4 Tail x 3/4 BSPTM |
| LPT-BTM-1216 | 3/4 Tail x 1 BSPTM |
| LPT-BTM-1608 | 1 Tail x 1/2 BSPTM |
| LPT-BTM-1612 | 1 Tail x 3/4 BSPTM |
| LPT-BTM-1616 | 1 Tail x 1 BSPTM |
| LPT-BTM-1620 | 1 Tail x 1-1/4 BSPTM |
| LPT-BTM-1624 | 1 Tail x 1-1/4 BSPTM |
| LPT-BTM-2012 | 1-1/4 Tail x 3/4 BSPTM |
| LPT-BTM-2016 | 1-1/4 Tail x 1 BSPTM |
| LPT-BTM-2020 | 1-1/4 Tail x 1-1/4 BSPTM |
| LPT-BTM-2024 | 1-1/4 Tail x 1-1/2 BSPTM |
| LPT-BTM-2416 | 1-1/2 Tail x 1 BSPTM |
| LPT-BTM-2420 | 1-1/2 Tail x 1-1/4 BSPTM |
| LPT-BTM-2424 | 1-1/2 Tail x 1-1/2 BSPTM |
| LPT-BTM-2432 | 1-1/2 Tail x 2 BSPTM |
| LPT-BTM-3224 | 2 Tail x 1-1/2 BSPTM |
| LPT-BTM-3232 | 2 Tail x 2 BSPTM |

UNO Male to Low Pressure Hosetail

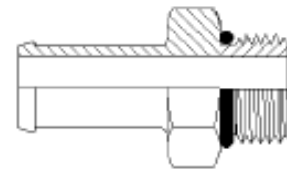

| | |
|--------------|--------------------------|
| LPT-UNM-1217 | 3/4 Tail x 1-1/16 UNOM |
| LPT-UNM-1617 | 1 Tail x 1-1/16 UNOM |
| LPT-UNM-1621 | 1 Tail x 1-5/16 UNOM |
| LPT-UNM-2017 | 1-1/4 Tail x 1-1/16 UNOM |
| LPT-UNM-2021 | 1-1/4 Tail x 1-5/16 UNOM |
| LPT-UNM-2026 | 1-1/4 Tail x 1-5/8 UNOM |
| LPT-UNM-2417 | 1-1/2 Tail x 1-1/16 UNOM |
| LPT-UNM-2421 | 1-1/2 Tail x 1-5/16 UNOM |
| LPT-UNM-2426 | 1-1/2 Tail x 1-5/16 UNOM |
| LPT-UNM-2430 | 1-1/2 Tail x 1-7/8 UNOM |

90 Degree

BSPP Male to Low Pressure Hosetail 90 Degree

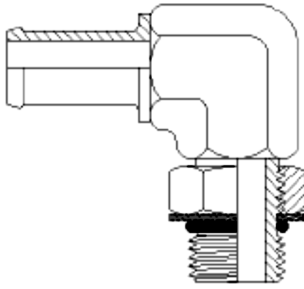

| | |
|------------------|------------------------------|
| LPT-BPM-90C-1212 | 3/4 Tail x 3/4 BSPPM 90° |
| LPT-BPM-90C-1608 | 1 Tail x 1/2 BSPPM 90° |
| LPT-BPM-90C-1612 | 1 Tail x 3/4 BSPPM 90° |
| LPT-BPM-90C-1616 | 1 Tail x 1 BSPPM 90° |
| LPT-BPM-90C-1620 | 1 Tail x 1-1/4 BSPPM 90° |
| LPT-BPM-90C-2012 | 1-1/4 Tail x 3/4 BSPPM 90° |
| LPT-BPM-90C-2016 | 1-1/4 Tail x 1 BSPPM 90° |
| LPT-BPM-90C-2020 | 1-1/4 Tail x 1-1/4 BSPPM 90° |
| LPT-BPM-90C-2024 | 1-1/4 Tail x 1-1/2 BSPPM 90° |
| LPT-BPM-90C-2416 | 1-1/2 Tail x 1 BSPPM 90° |
| LPT-BPM-90C-2420 | 1-1/2 Tail x 1-1/4 BSPPM 90° |
| LPT-BPM-90C-2424 | 1-1/2 Tail x 1-1/2 BSPPM 90° |

BSPT Male to Low Pressure Hosetail 90 Degree

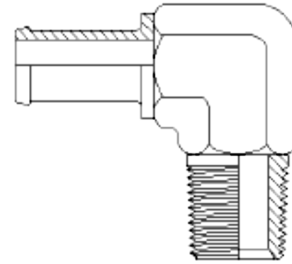

| | |
|------------------|------------------------------|
| LPT-BTM-90C-0808 | 1/2 Tail x 1/2 BSPTM 90° |
| LPT-BTM-90C-1208 | 3/4 Tail x 1/2 BSPTM 90° |
| LPT-BTM-90C-1212 | 3/4 Tail x 3/4 BSPTM 90° |
| LPT-BTM-90C-1216 | 3/4 Tail x 1 BSPTM 90° |
| LPT-BTM-90C-1220 | 3/4 Tail x 1-1/4 BSPTM 90° |
| LPT-BTM-90C-1608 | 1 Tail x 1/2 BSPTM 90° |
| LPT-BTM-90C-1612 | 1 Tail x 3/4 BSPTM 90° |
| LPT-BTM-90C-1616 | 1 Tail x 1 BSPTM 90° |
| LPT-BTM-90C-1620 | 1 Tail x 1-1/4 BSPTM 90° |
| LPT-BTM-90C-2012 | 1-1/4 Tail x 3/4 BSPTM 90° |
| LPT-BTM-90C-2016 | 1-1/4 Tail x 1 BSPTM 90° |
| LPT-BTM-90C-2020 | 1-1/4 Tail x 1-1/4 BSPTM 90° |
| LPT-BTM-90C-2024 | 1-1/4 Tail x 1-1/2 BSPTM 90° |
| LPT-BTM-90C-2416 | 1-1/2 Tail x 1 BSPTM 90° |
| LPT-BTM-90C-2420 | 1-1/2 Tail x 1-1/4 BSPTM 90° |
| LPT-BTM-90C-2424 | 1-1/2 Tail x 1-1/2 BSPTM 90° |
| LPT-BTM-90C-3220 | 2 Tail x 1-1/4 BSPTM 90° |
| LPT-BTM-90C-3224 | 2 Tail x 1-1/2 BSPTM 90° |
| LPT-BTM-90C-3232 | 2 Tail x 2 BSPTM 90° |

UNO Male to Low Pressure Hosetail 90 Degree

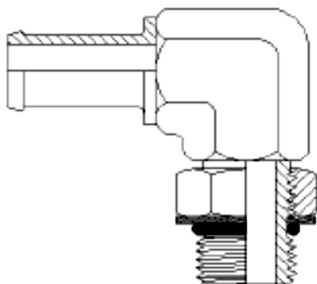

| | |
|------------------|------------------------------|
| LPT-UNM-90C-1212 | 3/4 Tail x 3/4 UNOM 90° |
| LPT-UNM-90C-1217 | 3/4 Tail x 1-1/16 UNOM 90° |
| LPT-UNM-90C-1617 | 1 Tail x 1-1/16 UNOM 90° |
| LPT-UNM-90C-1621 | 1 Tail x 1-5/16 UNOM 90° |
| LPT-UNM-90C-2017 | 1-1/4 Tail x 1-1/16 UNOM 90° |
| LPT-UNM-90C-2021 | 1-1/4 Tail x 1-5/16 UNOM 90° |
| LPT-UNM-90C-2026 | 1-1/4 Tail x 1-5/8 UNOM 90° |
| LPT-UNM-90C-2421 | 1-1/2 Tail x 1-5/16 UNOM 90° |
| LPT-UNM-90C-2426 | 1-1/2 Tail x 1-5/8 UNOM 90° |
| LPT-UNM-90C-2430 | 1-1/2 Tail x 1-7/8 UNOM 90° |

Push On Hosetails

BSPP Female to Push On Hosetail

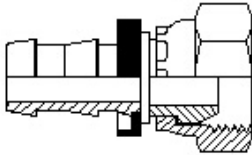

| | |
|-------------|--------------------------|
| PO-BSF-0402 | 1/8 Pushlock x 1/4 BSPFS |
| PO-BSF-0404 | 1/4 Pushlock x 1/4 BSPFS |
| PO-BSF-0406 | 1/4 Pushlock x 3/8 BSPFS |
| PO-BSF-0604 | 3/8 Pushlock x 1/4 BSPFS |
| PO-BSF-0606 | 3/8 Pushlock x 3/8 BSPFS |
| PO-BSF-0608 | 3/8 Pushlock x 1/2 BSPFS |
| PO-BSF-0806 | 1/2 Pushlock x 3/8 BSPFS |
| PO-BSF-0808 | 1/2 Pushlock x 1/2 BSPFS |
| PO-BSF-1008 | 5/8 Pushlock x 1/2 BSPFS |
| PO-BSF-1212 | 3/4 Pushlock x 3/4 BSPFS |
| PO-BSF-1616 | 1 Pushlock x 1 BSPFS |

JIC Male to Push On Hosetail

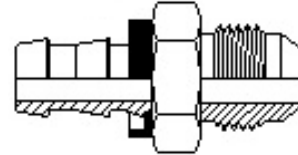

| | |
|-------------|----------------------------|
| PO-JIM-0407 | 1/4 Pushlock x 7/16 JICM |
| PO-JIM-0409 | 1/4 Pushlock x 9/16 JICM |
| PO-JIM-0609 | 3/8 Pushlock x 9/16 JICM |
| PO-JIM-0612 | 3/8 Pushlock x 3/4 JICM |
| PO-JIM-0812 | 1/2 Pushlock x 3/4 JICM |
| PO-JIM-0814 | 1/2 Pushlock x 7/8 JICM |
| PO-JIM-0817 | 1/2 Pushlock x 1-1/16 JICM |
| PO-JIM-1014 | 5/8 Pushlock x 7/8 JICM |
| PO-JIM-1017 | 5/8 Pushlock x 1-1/16 JICM |
| PO-JIM-1214 | 3/4 Pushlock x 7/8 JICM |
| PO-JIM-1217 | 3/4 Pushlock x 1-1/16 JICM |

BSPT Male to Push On Hosetail

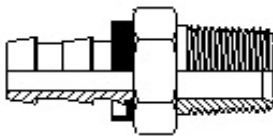

| | |
|-------------|--------------------------|
| PO-BTM-0404 | 1/4 Pushlock x 1/4 BSPTM |
| PO-BTM-0604 | 3/8 Pushlock x 1/4 BSPTM |
| PO-BTM-0606 | 3/8 Pushlock x 3/8 BSPTM |
| PO-BTM-0806 | 1/2 Pushlock x 3/8 BSPTM |
| PO-BTM-0808 | 1/2 Pushlock x 1/2 BSPTM |
| PO-BTM-1212 | 3/4 Pushlock x 3/4 BSPTM |

BSPP Female 90° to Push On Hosetail

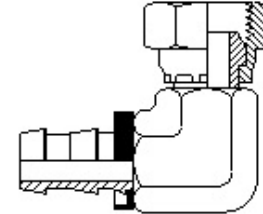

| | |
|-----------------|------------------------------|
| PO-BSF-90C-0404 | 1/4 Pushlock x 1/4 BSPFS 90° |
| PO-BSF-90C-0606 | 3/8 Pushlock x 3/8 BSPFS 90° |
| PO-BSF-90C-0808 | 1/2 Pushlock x 1/2 BSPFS 90° |
| PO-BSF-90C-1212 | 3/4 Pushlock x 3/4 BSPFS 90° |

JIC Female to Push On Hosetail

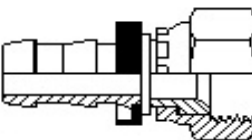

| | |
|-------------|-----------------------------|
| PO-JIF-0407 | 1/4 Pushlock x 7/16 JICFS |
| PO-JIF-0408 | 1/4 Pushlock x 1/2 JICFS |
| PO-JIF-0409 | 1/4 Pushlock x 9/16 JICFS |
| PO-JIF-0609 | 3/8 Pushlock x 9/16 JICFS |
| PO-JIF-0612 | 3/8 Pushlock x 3/4 JICFS |
| PO-JIF-0812 | 1/2 Pushlock x 3/4 JICFS |
| PO-JIF-0814 | 1/2 Pushlock x 7/8 JICFS |
| PO-JIF-1014 | 5/8 Pushlock x 7/8 JICFS |
| PO-JIF-1217 | 3/4 Pushlock x 1-1/16 JICFS |
| PO-JIF-1621 | 1 Pushlock x 1-5/16 JICFS |

JIC Female 90° to Push On Hosetail

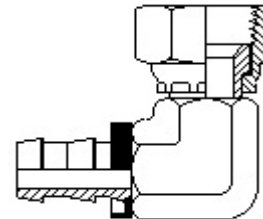

| | |
|-----------------|---------------------------------|
| PO-JIF-90C-0407 | 1/4 Pushlock x 7/16 JICFS 90° |
| PO-JIF-90C-0409 | 1/4 Pushlock x 9/16 JICFS 90° |
| PO-JIF-90C-0609 | 3/8 Pushlock x 9/16 JICFS 90° |
| PO-JIF-90C-0612 | 3/8 Pushlock x 3/4 JICFS 90° |
| PO-JIF-90C-0812 | 1/2 Pushlock x 3/4 JICFS 90° |
| PO-JIF-90C-0814 | 1/2 Pushlock x 7/8 JICFS 90° |
| PO-JIF-90C-1014 | 5/8 Pushlock x 7/8 JICFS 90° |
| PO-JIF-90C-1217 | 3/4 Pushlock x 1-1/16 JICFS 90° |

Re-Usable Hosetails

Ferrule - 1 wire

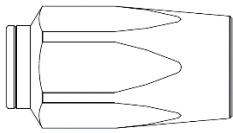

| | |
|---------|------------------------------|
| SNR1-04 | Re-Usable 1 Wire Ferrule 1/4 |
| SNR1-06 | Re-Usable 1 Wire Ferrule 3/8 |
| SNR1-08 | Re-Usable 1 Wire Ferrule 1/2 |
| SNR1-12 | Re-Usable 1 Wire Ferrule 3/4 |
| SNR1-16 | Re-Usable 1 Wire Ferrule 1 |

Ferrule - 2 wire

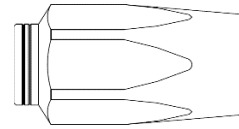

| | |
|---------|------------------------------|
| SNR2-04 | Re-Usable 2 Wire Ferrule 1/4 |
| SNR2-06 | Re-Usable 2 Wire Ferrule 3/8 |
| SNR2-08 | Re-Usable 2 Wire Ferrule 1/2 |
| SNR2-12 | Re-Usable 2 Wire Ferrule 3/4 |
| SNR2-16 | Re-Usable 2 Wire Ferrule 1 |

BSPT Male to R1/R2 Hose

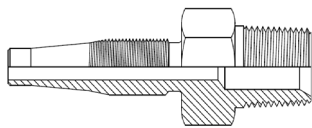

| | |
|------------|--------------------------------|
| R-BTM-0402 | 1/4 Re-Usable Tail x 1/8 BSPTM |
| R-BTM-0404 | 1/4 Re-Usable Tail x 1/4 BSPTM |
| R-BTM-0406 | 1/4 Re-Usable Tail x 3/8 BSPTM |
| R-BTM-0604 | 3/8 Re-Usable Tail x 1/4 BSPTM |
| R-BTM-0606 | 3/8 Re-Usable Tail x 3/8 BSPTM |
| R-BTM-0608 | 3/8 Re-Usable Tail x 1/2 BSPTM |
| R-BTM-0806 | 1/2 Re-Usable Tail x 3/8 BSPTM |
| R-BTM-0808 | 1/2 Re-Usable Tail x 1/2 BSPTM |
| R-BTM-1212 | 3/4 Re-Usable Tail x 3/4 BSPTM |
| R-BTM-1616 | 1 Re-Usable Tail x 1 BSPTM |

BSPF Female Swivel to R1/R2 Hose

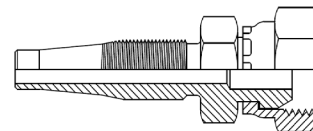

| | |
|------------|--------------------------------|
| R-BSF-0402 | 1/4 Re-Usable Tail x 1/8 BSPFS |
| R-BSF-0404 | 1/4 Re-Usable Tail x 1/4 BSPFS |
| R-BSF-0406 | 1/4 Re-Usable Tail x 3/8 BSPFS |
| R-BSF-0604 | 3/8 Re-Usable Tail x 1/4 BSPFS |
| R-BSF-0606 | 3/8 Re-Usable Tail x 3/8 BSPFS |
| R-BSF-0608 | 3/8 Re-Usable Tail x 1/2 BSPFS |
| R-BSF-0806 | 1/2 Re-Usable Tail x 3/8 BSPFS |
| R-BSF-0808 | 1/2 Re-Usable Tail x 1/2 BSPFS |
| R-BSF-1212 | 3/4 Re-Usable Tail x 3/4 BSPFS |
| R-BSF-1616 | 1 Re-Usable Tail x 1 BSPFS |

JIC Female Swivel to R1/R2 Hose

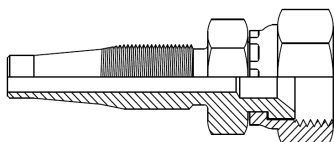

| | |
|------------|-----------------------------------|
| R-JIF-0407 | 1/4 Re-Usable Tail x 7/16 JICFS |
| R-JIF-0409 | 1/4 Re-Usable Tail x 9/16 JICFS |
| R-JIF-0609 | 3/8 Re-Usable Tail x 9/16 JICFS |
| R-JIF-0612 | 3/8 Re-Usable Tail x 3/4 JICFS |
| R-JIF-0614 | 3/8 Re-Usable Tail x 7/8 JICFS |
| R-JIF-0812 | 1/2 Re-Usable Tail x 3/4 JICFS |
| R-JIF-0814 | 1/2 Re-Usable Tail x 7/8 JICFS |
| R-JIF-1217 | 3/4 Re-Usable Tail x 1-1/16 JICFS |
| R-JIF-1221 | 3/4 Re-Usable Tail x 1-5/16 JICFS |
| R-JIF-1621 | 1 Re-Usable Tail x 1-5/16 JICFS |

JIC Male to R1/R2 Hose

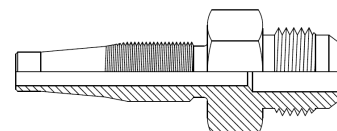

| | |
|------------|----------------------------------|
| R-JIM-0407 | 1/4 Re-Usable Tail x 7/16 JICM |
| R-JIM-0408 | 1/4 Re-Usable Tail x 1/2 JICM |
| R-JIM-0409 | 1/4 Re-Usable Tail x 9/16 JICM |
| R-JIM-0609 | 3/8 Re-Usable Tail x 9/16 JICM |
| R-JIM-0612 | 3/8 Re-Usable Tail x 3/4 JICM |
| R-JIM-0812 | 1/2 Re-Usable Tail x 3/4 JICM |
| R-JIM-0814 | 1/2 Re-Usable Tail x 7/8 JICM |
| R-JIM-1217 | 3/4 Re-Usable Tail x 1-1/16 JICM |
| R-JIM-1621 | 1 Re-Usable Tail x 1-5/16 JICM |

ORFS Female Swivel to R1/R2 Hose

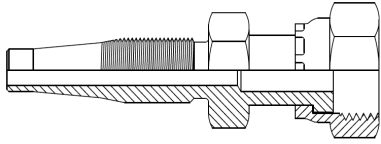

| | |
|------------|----------------------------------|
| R-ORF-0409 | 1/4 Re-Usable Tail x 9/16 ORFSF |
| R-ORF-0611 | 3/8 Re-Usable Tail x 11/16 ORFSF |
| R-ORF-0813 | 1/2 Re-Usable Tail x 13/16 ORFSF |

45 Degree

BSPF Female Swivel 45° Swept to R1/R2 Hose

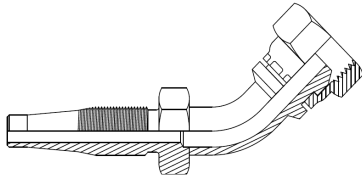

| | |
|----------------|------------------------------------|
| R-BSF-45S-0404 | 1/4 Re-Usable Tail x 1/4 BSPPF 45° |
| R-BSF-45S-0606 | 3/8 Re-Usable Tail x 3/8 BSPPF 45° |
| R-BSF-45S-0808 | 1/2 Re-Usable Tail x 1/2 BSPPF 45° |
| R-BSF-45S-1212 | 3/4 Re-Usable Tail x 3/4 BSPPF 45° |
| R-BSF-45S-1616 | 1 Re-Usable Tail x 1 BSPPF 45° |

JIC Female Swivel 45° Swept to R1/R2 Hose

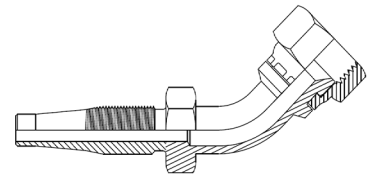

| | |
|----------------|---------------------------------------|
| R-JIF-45S-0407 | 1/4 Re-Usable Tail x 7/16 JICFS 45° |
| R-JIF-45S-0409 | 1/4 Re-Usable Tail x 9/16 JICFS 45° |
| R-JIF-45S-0609 | 3/8 Re-Usable Tail x 9/16 JICFS 45° |
| R-JIF-45S-0612 | 3/8 Re-Usable Tail x 3/4 JICFS 45° |
| R-JIF-45S-0812 | 1/2 Re-Usable Tail x 3/4 JICFS 45° |
| R-JIF-45S-0814 | 1/2 Re-Usable Tail x 7/8 JICFS 45° |
| R-JIF-45S-1217 | 3/4 Re-Usable Tail x 1-1/16 JICFS 45° |
| R-JIF-45S-1621 | 1 Re-Usable Tail x 1-5/16 JICFS 45° |

90 Degree Compact

BSPF Female Swivel 90 Compact to R1/R2 Hose

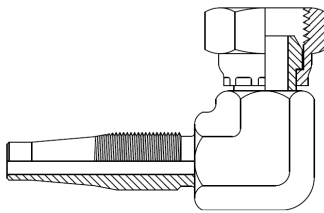

| | |
|----------------|------------------------------------|
| R-BSF-90C-0404 | 1/4 Re-Usable Tail x 1/4 BSPFS 90° |
| R-BSF-90C-0606 | 3/8 Re-Usable Tail x 3/8 BSPFS 90° |
| R-BSF-90C-0608 | 3/8 Re-Usable Tail x 1/2 BSPFS 90° |
| R-BSF-90C-0808 | 1/2 Re-Usable Tail x 1/2 BSPFS 90° |
| R-BSF-90C-1212 | 3/4 Re-Usable Tail x 3/4 BSPFS 90° |
| R-BSF-90C-1616 | 1 Re-Usable Tail x 1 BSPFS 90° |

JIC Female Swivel 90 Degree Compact to R1/R2 Hose

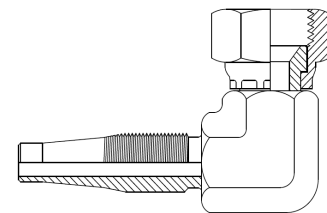

| | |
|----------------|---------------------------------------|
| R-JIF-90C-0407 | 1/4 Re-Usable Tail x 7/16 JICFS 90° |
| R-JIF-90C-0409 | 1/4 Re-Usable Tail x 9/16 JICFS 90° |
| R-JIF-90C-0609 | 3/8 Re-Usable Tail x 9/16 JICFS 90° |
| R-JIF-90C-0612 | 3/8 Re-Usable Tail x 3/4 JICFS 90° |
| R-JIF-90C-0812 | 1/2 Re-Usable Tail x 3/4 JICFS 90° |
| R-JIF-90C-0814 | 1/2 Re-Usable Tail x 7/8 JICFS 90° |
| R-JIF-90C-1217 | 3/4 Re-Usable Tail x 1-1/16 JICFS 90° |

90 Degree Swept

BSPF Female Swivel 90 Swept to R1/R2 Hose

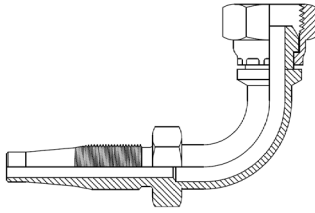

| | |
|----------------|------------------------------------|
| R-BSF-90S-0404 | 1/4 Re-Usable Tail x 1/4 BSPFS 90° |
| R-BSF-90S-0606 | 3/8 Re-Usable Tail x 3/8 BSPFS 90° |
| R-BSF-90S-0608 | 3/8 Re-Usable Tail x 1/2 BSPFS 90° |
| R-BSF-90S-0808 | 1/2 Re-Usable Tail x 1/2 BSPFS 90° |
| R-BSF-90S-1212 | 3/4 Re-Usable Tail x 3/4 BSPFS 90° |
| R-BSF-90S-1616 | 1 Re-Usable Tail x 1 BSPFS 90° |

ORFS Female Swivel 90 Swept to R1/R2 Hose

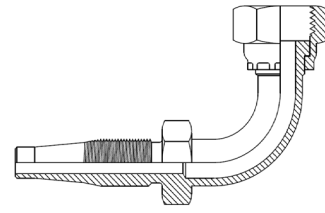

| | |
|----------------|--------------------------------------|
| R-ORF-90S-0409 | 1/4 Re-Usable Tail x 9/16 ORFSF 90° |
| R-ORF-90S-0611 | 3/8 Re-Usable Tail x 11/16 ORFSF 90° |
| R-ORF-90S-0813 | 1/2 Re-Usable Tail x 13/16 ORFSF 90° |

JIC Female Swivel 90 Swept to R1/R2 Hose

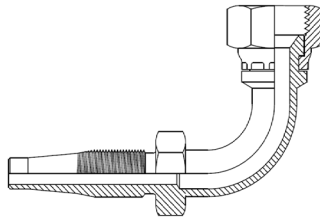

| | |
|-----------------|---|
| R-JIF-90S-0407 | 1/4 Re-Usable Tail x 7/16 JICFS 90° |
| R-JIF-90S-0408 | 1/4 Re-Usable Tail x 1/2 JICFS 90° |
| R-JIF-90S-0409 | 1/4 Re-Usable Tail x 9/16 JICFS 90° |
| R-JIF-90S-0409E | 1/4 Re-Usable Tail x 9/16 JICFS 90° Long Drop |
| R-JIF-90S-0609 | 3/8 Re-Usable Tail x 9/16 JICFS 90° |
| R-JIF-90S-0609E | 3/8 Re-Usable Tail x 9/16 JICFS 90° Long Drop |
| R-JIF-90S-0612 | 3/8 Re-Usable Tail x 3/4 JICFS 90° |
| R-JIF-90S-0612E | 3/8 Re-Usable Tail x 3/4 JICFS 90° Long Drop |
| R-JIF-90S-0812 | 1/2 Re-Usable Tail x 3/4 JICFS 90° |
| R-JIF-90S-0814 | 1/2 Re-Usable Tail x 7/8 JICFS 90° |
| R-JIF-90S-1217 | 3/4 Re-Usable Tail x 1-1/16 JICFS 90° |
| R-JIF-90S-1221 | 3/4 Re-Usable Tail x 1-5/16 JICFS 90° |
| R-JIF-90S-1621 | 1 Re-Usable Tail x 1-5/16 JICFS 90° |

R5 Re-Usable Hosetails

BSPF Female Swivel to R5 Hose

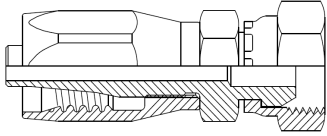

| | |
|-------------|--------------------------------|
| R5-BSF-0404 | -4 Re-Usable Tail x 1/4 BSPFS |
| R5-BSF-0606 | -6 Re-Usable Tail x 3/8 BSPFS |
| R5-BSF-0808 | -8 Re-Usable Tail x 1/2 BSPFS |
| R5-BSF-1212 | -12 Re-Usable Tail x 3/4 BSPFS |
| R5-BSF-1616 | -16 Re-Usable Tail x 1 BSPFS |

SAE Female Swivel (45 Degree Cone) to R5 Hose

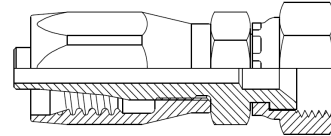

| | |
|-------------|--|
| R5-SAF-0610 | -6 Re-Usable Tail x 5/8 SAE Female |
| R5-SAF-1217 | -12 Re-Usable Tail x 1-1/16 SAE Female |

JIC Female Swivel to R5 Hose

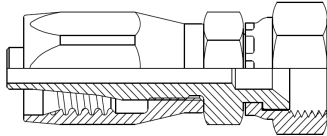

| | |
|-------------|-----------------------------------|
| R5-JIF-0407 | -4 Re-Usable Tail x 7/16 JICFS |
| R5-JIF-0508 | -5 Re-Usable Tail x 1/2 JICFS |
| R5-JIF-0609 | -6 Re-Usable Tail x 9/16 JICFS |
| R5-JIF-0812 | -8 Re-Usable Tail x 3/4 JICFS |
| R5-JIF-1012 | -10 Re-Usable Tail x 3/4 JICFS |
| R5-JIF-1014 | -10 Re-Usable Tail x 7/8 JICFS |
| R5-JIF-1214 | -12 Re-Usable Tail x 7/8 JICFS |
| R5-JIF-1217 | -12 Re-Usable Tail x 1-1/16 JICFS |
| R5-JIF-1621 | -16 Re-Usable Tail x 1-5/16 JICFS |

JIC Female Swivel 45° Swept to R5 Hose

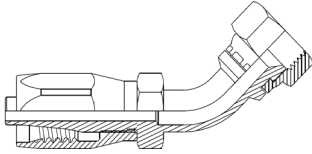

| | |
|-----------------|---------------------------------------|
| R5-JIF-45S-0407 | -4 Re-Usable Tail x 7/16 JICFS 45° |
| R5-JIF-45S-0609 | -6 Re-Usable Tail x 9/16 JICFS 45° |
| R5-JIF-45S-0812 | -8 Re-Usable Tail x 3/4 JICFS 45° |
| R5-JIF-45S-1014 | -10 Re-Usable Tail x 7/8 JICFS 45° |
| R5-JIF-45S-1217 | -12 Re-Usable Tail x 1-1/16 JICFS 45° |
| R5-JIF-45S-1621 | -16 Re-Usable Tail x 1-5/16 JICFS 45° |

JIC Female Swivel 90 Swept to R5 Hose

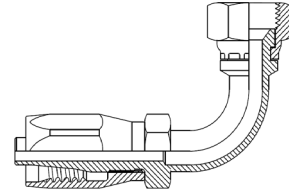

| | |
|-----------------|---------------------------------------|
| R5-JIF-90S-0407 | -4 Re-Usable Tail x 7/16 JICFS 90° |
| R5-JIF-90S-0609 | -6 Re-Usable Tail x 9/16 JICFS 90° |
| R5-JIF-90S-0812 | -8 Re-Usable Tail x 3/4 JICFS 90° |
| R5-JIF-90S-1012 | -10 Re-Usable Tail x 3/4 JICFS 90° |
| R5-JIF-90S-1014 | -10 Re-Usable Tail x 7/8 JICFS 90° |
| R5-JIF-90S-1217 | -12 Re-Usable Tail x 1-1/16 JICFS 90° |
| R5-JIF-90S-1621 | -16 Re-Usable Tail x 1-5/16 JICFS 90° |

SAE Female Swivel (45 Degree Cone) to R5 Hose

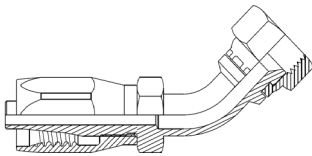

| | |
|-----------------|--|
| R5-SAF-45S-0610 | -6 Re-Usable Tail x 5/8 SAE Female 45° |
|-----------------|--|

SAE Female Swivel (45 Degree Cone) to R5 Hose

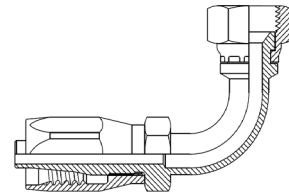

| | |
|-----------------|--|
| R5-SAF-90S-0610 | -6 Re-Usable Tail x 5/8 SAE Female 90° |
|-----------------|--|



One Piece Hosetails Straight R1/R2 Hose

BSPF Female Swivel to R1/R2 Hose

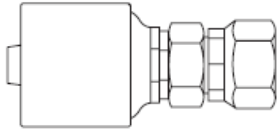

| | |
|--------------|--------------------------|
| STO-BSF-0402 | 1/4 Tail x 1/8 BSPFS |
| STO-BSF-0404 | 1/4 Tail x 1/4 BSPFS |
| STO-BSF-0406 | 1/4 Tail x 3/8 BSPFS |
| STO-BSF-0506 | 5/16 Tail x 3/8 BSPFS |
| STO-BSF-0606 | 3/8 Tail x 3/8 BSPFS |
| STO-BSF-0608 | 3/8 Tail x 1/2 BSPFS |
| STO-BSF-0806 | 1/2 Tail x 3/8 BSPFS |
| STO-BSF-0808 | 1/2 Tail x 1/2 BSPFS |
| STO-BSF-0810 | 1/2 Tail x 5/8 BSPFS |
| STO-BSF-0812 | 1/2 Tail x 3/4 BSPFS |
| STO-BSF-1010 | 5/8 Tail x 5/8 BSPFS |
| STO-BSF-1012 | 5/8 Tail x 3/4 BSPFS |
| STO-BSF-1212 | 3/4 Tail x 3/4 BSPFS |
| STO-BSF-1216 | 3/4 Tail x 1 BSPFS |
| STO-BSF-1616 | 1 Tail x 1 BSPFS |
| STO-BSF-2020 | 1-1/4 Tail x 1-1/4 BSPFS |

JIC Female Swivel to R1/R2 Hose

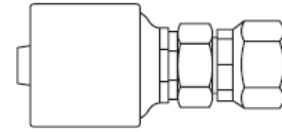

| | |
|--------------|--------------------------|
| STO-JIF-0407 | 1/4 Tail x 7/16 JICFS |
| STO-JIF-0408 | 1/4 Tail x 1/2 JICFS |
| STO-JIF-0409 | 1/4 Tail x 9/16 JICFS |
| STO-JIF-0508 | 5/16 Tail x 1/2 JICFS |
| STO-JIF-0509 | 5/16 Tail x 9/16 JICFS |
| STO-JIF-0607 | 3/8 Tail x 7/16 JICFS |
| STO-JIF-0608 | 3/8 Tail x 1/2 JICFS |
| STO-JIF-0609 | 3/8 Tail x 9/16 JICFS |
| STO-JIF-0612 | 3/8 Tail x 3/4 JICFS |
| STO-JIF-0614 | 3/8 Tail x 7/8 JICFS |
| STO-JIF-0617 | 3/8 Tail x 1-1/16 JICFS |
| STO-JIF-0809 | 1/2 Tail x 9/16 JICFS |
| STO-JIF-0812 | 1/2 Tail x 3/4 JICFS |
| STO-JIF-0814 | 1/2 Tail x 7/8 JICFS |
| STO-JIF-0817 | 1/2 Tail x 1-1/16 JICFS |
| STO-JIF-1012 | 5/8 Tail x 3/4 JICFS |
| STO-JIF-1014 | 5/8 Tail x 7/8 JICFS |
| STO-JIF-1017 | 5/8 Tail x 1-1/16 JICFS |
| STO-JIF-1214 | 3/4 Tail x 7/8 JICFS |
| STO-JIF-1217 | 3/4 Tail x 1-1/16 JICFS |
| STO-JIF-1219 | 3/4 Tail x 1-3/16 JICFS |
| STO-JIF-1221 | 3/4 Tail x 1-5/16 JICFS |
| STO-JIF-1617 | 1 Tail x 1-1/16 JICFS |
| STO-JIF-1619 | 1 Tail x 1-3/16 JICFS |
| STO-JIF-1621 | 1 Tail x 1-5/16 JICFS |
| STO-JIF-1626 | 1 Tail x 1-5/8 JICFS |
| STO-JIF-2026 | 1-1/4 Tail x 1-5/8 JICFS |

BSPT Male to R1/R2 Hose

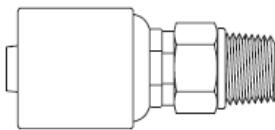

| | |
|--------------|----------------------|
| STO-BTM-0402 | 1/4 Tail x 1/8 BSPTM |
| STO-BTM-0404 | 1/4 Tail x 1/4 BSPTM |
| STO-BTM-0406 | 1/4 Tail x 3/8 BSPTM |
| STO-BTM-0606 | 3/8 Tail x 3/8 BSPTM |
| STO-BTM-0608 | 3/8 Tail x 1/2 BSPTM |
| STO-BTM-0806 | 1/2 Tail x 3/8 BSPTM |
| STO-BTM-0808 | 1/2 Tail x 1/2 BSPTM |
| STO-BTM-1010 | 5/8 Tail x 5/8 BSPTM |
| STO-BTM-1212 | 3/4 Tail x 3/4 BSPTM |
| STO-BTM-1616 | 1 Tail x 1 BSPTM |

JIC Male to R1/R2 Hose

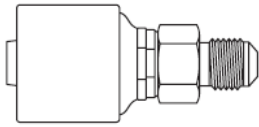

| | |
|--------------|-------------------------|
| STO-JIM-0407 | 1/4 Tail x 7/16 JICM |
| STO-JIM-0408 | 1/4 Tail x 1/2 JICM |
| STO-JIM-0409 | 1/4 Tail x 9/16 JICM |
| STO-JIM-0412 | 1/4 Tail x 3/4 JICM |
| STO-JIM-0509 | 5/16 Tail x 9/16 JICM |
| STO-JIM-0609 | 3/8 Tail x 9/16 JICM |
| STO-JIM-0612 | 3/8 Tail x 3/4 JICM |
| STO-JIM-0614 | 3/8 Tail x 7/8 JICM |
| STO-JIM-0812 | 1/2 Tail x 3/4 JICM |
| STO-JIM-0814 | 1/2 Tail x 7/8 JICM |
| STO-JIM-0817 | 1/2 Tail x 1-1/16 JICM |
| STO-JIM-1014 | 5/8 Tail x 7/8 JICM |
| STO-JIM-1017 | 5/8 Tail x 1-1/16 JICM |
| STO-JIM-1217 | 3/4 Tail x 1-1/16 JICM |
| STO-JIM-1219 | 3/4 Tail x 1-3/16 JICM |
| STO-JIM-1221 | 3/4 Tail x 1-5/16 JICM |
| STO-JIM-1621 | 1 Tail x 1-5/16 JICM |
| STO-JIM-1626 | 1 Tail x 1-5/8 JICM |
| STO-JIM-2026 | 1-1/4 Tail x 1-5/8 JICM |

Metric Heavy Female Swivel to R1/R2 Hose

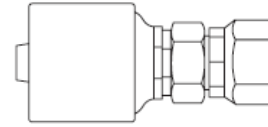

| | |
|--------------|-------------------------------|
| STO-MHF-0414 | 1/4 Tail x M14 Heavy Female |
| STO-MHF-0416 | 1/4 Tail x M16 Heavy Female |
| STO-MHF-0418 | 1/4 Tail x M18 Heavy Female |
| STO-MHF-0420 | 1/4 Tail x M20 Heavy Female |
| STO-MHF-0520 | 5/16 Tail x M20 Heavy Female |
| STO-MHF-0618 | 3/8 Tail x M18 Heavy Female |
| STO-MHF-0620 | 3/8 Tail x M20 Heavy Female |
| STO-MHF-0622 | 3/8 Tail x M22 Heavy Female |
| STO-MHF-0820 | 1/2 Tail x M20 Heavy Female |
| STO-MHF-0822 | 1/2 Tail x M22 Heavy Female |
| STO-MHF-0824 | 1/2 Tail x M24 Heavy Female |
| STO-MHF-0830 | 1/2 Tail x M30 Heavy Female |
| STO-MHF-1024 | 5/8 Tail x M24 Heavy Female |
| STO-MHF-1030 | 5/8 Tail x M30 Heavy Female |
| STO-MHF-1230 | 3/4 Tail x M30 Heavy Female |
| STO-MHF-1236 | 3/4 Tail x M36 Heavy Female |
| STO-MHF-1636 | 1 Tail x M36 Heavy Female |
| STO-MHF-1642 | 1 Tail x M42 Heavy Female |
| STO-MHF-2052 | 1-1/4 Tail x M52 Heavy Female |

Metric Heavy Male to R1/R2 Hose

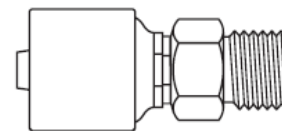

| | |
|--------------|---------------------------|
| STO-MHM-0416 | 1/4 Tail x M16 Heavy Male |
| STO-MHM-0418 | 1/4 Tail x M18 Heavy Male |
| STO-MHM-0618 | 3/8 Tail x M18 Heavy Male |
| STO-MHM-0620 | 3/8 Tail x M20 Heavy Male |
| STO-MHM-0622 | 3/8 Tail x M22 Heavy Male |
| STO-MHM-0820 | 1/2 Tail x M20 Heavy Male |
| STO-MHM-0824 | 1/2 Tail x M24 Heavy Male |
| STO-MHM-1030 | 5/8 Tail x M30 Heavy Male |
| STO-MHM-1230 | 3/4 Tail x M30 Heavy Male |
| STO-MHM-1236 | 3/4 Tail x M36 Heavy Male |
| STO-MHM-1636 | 1 Tail x M36 Heavy Male |
| STO-MHM-1642 | 1 Tail x M42 Heavy Male |

Metric Light Female Swivel to R1/R2 Hose

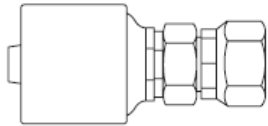

| | |
|--------------|------------------------------|
| STO-MLF-0412 | 1/4 Tail x M12 Light Female |
| STO-MLF-0414 | 1/4 Tail x M14 Light Female |
| STO-MLF-0416 | 1/4 Tail x M16 Light Female |
| STO-MLF-0418 | 1/4 Tail x M18 Light Female |
| STO-MLF-0516 | 5/16 Tail x M16 Light Female |
| STO-MLF-0518 | 5/16 Tail x M18 Light Female |
| STO-MLF-0616 | 3/8 Tail x M16 Light Female |
| STO-MLF-0618 | 3/8 Tail x M18 Light Female |
| STO-MLF-0622 | 3/8 Tail x M22 Light Female |
| STO-MLF-0818 | 1/2 Tail x M18 Light Female |
| STO-MLF-0822 | 1/2 Tail x M22 Light Female |
| STO-MLF-0826 | 1/2 Tail x M26 Light Female |
| STO-MLF-1026 | 5/8 Tail x M26 Light Female |
| STO-MLF-1226 | 3/4 Tail x M26 Light Female |
| STO-MLF-1230 | 3/4 Tail x M30 Light Female |
| STO-MLF-1636 | 1 Tail x M36 Light Female |

ORFS Female Swivel to R1/R2 Hose

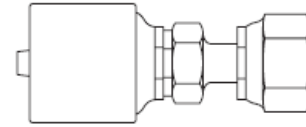

| | |
|--------------|----------------------------------|
| STO-ORF-0409 | 1/4 Tail x 9/16 ORFS Female |
| STO-ORF-0411 | 1/4 Tail x 11/16 ORFS Female |
| STO-ORF-0413 | 1/4 Tail x 13/16 ORFS Female |
| STO-ORF-0609 | 3/8 Tail x 11/16 ORFS Female |
| STO-ORF-0611 | 3/8 Tail x 11/16 ORFS Female |
| STO-ORF-0613 | 3/8 Tail x 13/16 ORFS Female |
| STO-ORF-0811 | 1/2 Tail x 11/16 ORFS Female |
| STO-ORF-0813 | 1/2 Tail x 13/16 ORFS Female |
| STO-ORF-0816 | 1/2 Tail x 1 ORFS Female |
| STO-ORF-0819 | 1/2 Tail x 1-3/16 ORFS Female |
| STO-ORF-1016 | 5/8 Tail x 1 ORFS Female |
| STO-ORF-1019 | 5/8 Tail x 1-3/16 ORFS Female |
| STO-ORF-1216 | 3/4 Tail x 1 ORFS Female |
| STO-ORF-1219 | 3/4 Tail x 1-3/16 ORFS Female |
| STO-ORF-1223 | 3/4 Tail x 1-7/16 ORFS Female |
| STO-ORF-1623 | 1 Tail x 1-7/16 ORFS Female |
| STO-ORF-2027 | 1-1/4 Tail x 1-11/16 ORFS Female |

Metric Light Male to R1/R2 Hose

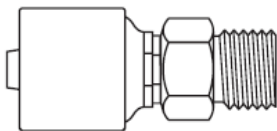

| | |
|--------------|------------------------------|
| STO-MLM-0412 | 1/4 Tail x M12 Light Female |
| STO-MLM-0414 | 1/4 Tail x M14 Light Female |
| STO-MLM-0416 | 1/4 Tail x M16 Light Female |
| STO-MLM-0418 | 1/4 Tail x M18 Light Female |
| STO-MLM-0518 | 5/16 Tail x M18 Light Female |
| STO-MLM-0616 | 3/8 Tail x M16 Light Female |
| STO-MLM-0618 | 3/8 Tail x M18 Light Female |
| STO-MLM-0622 | 3/8 Tail x M22 Light Female |
| STO-MLM-0818 | 1/2 Tail x M18 Light Female |
| STO-MLM-0822 | 1/2 Tail x M22 Light Female |
| STO-MLM-0826 | 1/2 Tail x M26 Light Female |
| STO-MLM-1026 | 5/8 Tail x M26 Light Female |
| STO-MLM-1030 | 5/8 Tail x M30 Light Female |
| STO-MLM-1226 | 3/4 Tail x M26 Light Female |
| STO-MLM-1230 | 3/4 Tail x M30 Light Female |
| STO-MLM-1636 | 1 Tail x M36 Light Female |

ORFS Female Swivel to R1/R2 Hose

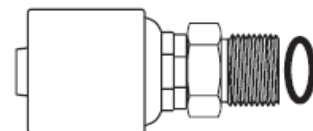

| | |
|--------------|--------------------------------|
| STO-ORM-0409 | 1/4 Tail x 9/16 ORFS Male |
| STO-ORM-0411 | 1/4 Tail x 11/16 ORFS Male |
| STO-ORM-0611 | 3/8 Tail x 11/16 ORFS Male |
| STO-ORM-0613 | 3/8 Tail x 13/16 ORFS Male |
| STO-ORM-0813 | 1/2 Tail x 13/16 ORFS Male |
| STO-ORM-0816 | 1/2 Tail x 1 ORFS Male |
| STO-ORM-0819 | 1/2 Tail x 1-3/16 ORFS Male |
| STO-ORM-1016 | 5/8 Tail x 1 ORFS Male |
| STO-ORM-1019 | 5/8 Tail x 1-3/16 ORFS Male |
| STO-ORM-1219 | 3/4 Tail x 1-3/16 ORFS Male |
| STO-ORM-1223 | 3/4 Tail x 1-7/16 ORFS Male |
| STO-ORM-1623 | 1 Tail x 1-7/16 ORFS Male |
| STO-ORM-2027 | 1-1/4 Tail x 1-11/16 ORFS Male |

UNO Male Live Swivel to R1/R2 Hose

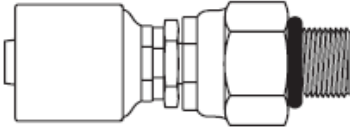

| | |
|--------------|-------------------------------------|
| STO-USM-0812 | 1/2 Tail x 3/4 UNO Live Swivel Male |
|--------------|-------------------------------------|



45 Degree Swept R1/R2 Hose

BSPF Female Swivel 45 Swept to R1/R2 Hose

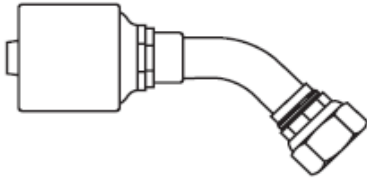

| | |
|------------------|------------------------------|
| STO-BSF-45S-0404 | 1/4 Tail x 1/4 BSPFS 45° |
| STO-BSF-45S-0406 | 1/4 Tail x 3/8 BSPFS 45° |
| STO-BSF-45S-0606 | 3/8 Tail x 3/8 BSPFS 45° |
| STO-BSF-45S-0608 | 3/8 Tail x 1/2 BSPFS 45° |
| STO-BSF-45S-0808 | 1/2 Tail x 1/2 BSPFS 45° |
| STO-BSF-45S-0810 | 1/2 Tail x 5/8 BSPFS 45° |
| STO-BSF-45S-1010 | 5/8 Tail x 5/8 BSPFS 45° |
| STO-BSF-45S-1012 | 5/8 Tail x 3/4 BSPFS 45° |
| STO-BSF-45S-1212 | 3/4 Tail x 3/4 BSPFS 45° |
| STO-BSF-45S-1616 | 1 Tail x 1 BSPFS 45° |
| STO-BSF-45S-2020 | 1-1/4 Tail x 1-1/4 BSPFS 45° |

Metric Heavy Female Swivel 45 Swept to R1/R2 Hose

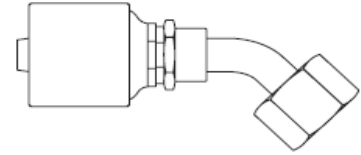

| | |
|------------------|--------------------------|
| STO-MHF-45S-0416 | 1/4 Tail x M16 Heavy 45° |
| STO-MHF-45S-0418 | 1/4 Tail x M18 Heavy 45° |
| STO-MHF-45S-0420 | 1/4 Tail x M20 Heavy 45° |
| STO-MHF-45S-0618 | 3/8 Tail x M18 Heavy 45° |
| STO-MHF-45S-0620 | 3/8 Tail x M20 Heavy 45° |
| STO-MHF-45S-0622 | 3/8 Tail x M22 Heavy 45° |
| STO-MHF-45S-0822 | 1/2 Tail x M22 Heavy 45° |
| STO-MHF-45S-0824 | 1/2 Tail x M24 Heavy 45° |
| STO-MHF-45S-1030 | 5/8 Tail x M30 Heavy 45° |
| STO-MHF-45S-1236 | 3/4 Tail x M36 Heavy 45° |
| STO-MHF-45S-1642 | 1 Tail x M42 Heavy 45° |

JIC Female Swivel 45 Degree Swept to R1/R2 Hose

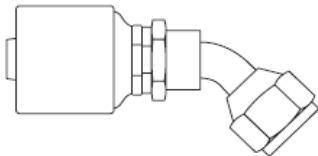

| | |
|------------------|------------------------------|
| STO-JIF-45S-0407 | 1/4 Tail x 7/16 JICFS 45° |
| STO-JIF-45S-0408 | 1/4 Tail x 1/2 JICFS 45° |
| STO-JIF-45S-0409 | 1/4 Tail x 9/16 JICFS 45° |
| STO-JIF-45S-0609 | 3/8 Tail x 9/16 JICFS 45° |
| STO-JIF-45S-0612 | 3/8 Tail x 3/4 JICFS 45° |
| STO-JIF-45S-0812 | 1/2 Tail x 3/4 JICFS 45° |
| STO-JIF-45S-0814 | 1/2 Tail x 7/8 JICFS 45° |
| STO-JIF-45S-1014 | 5/8 Tail x 7/8 JICFS 45° |
| STO-JIF-45S-1017 | 5/8 Tail x 1-1/16 JICFS 45° |
| STO-JIF-45S-1214 | 3/4 Tail x 7/8 JICFS 45° |
| STO-JIF-45S-1217 | 3/4 Tail x 1-1/16 JICFS 45° |
| STO-JIF-45S-1621 | 1 Tail x 1-5/16 JICFS 45° |
| STO-JIF-45S-2026 | 1-1/4 Tail x 1-5/8 JICFS 45° |

Metric Heavy Female Swivel 45 Swept to R1/R2 Hose

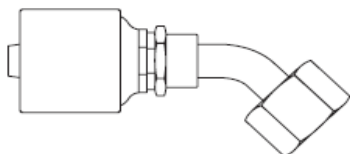

ORFS Female Swivel 45 Degree Swept to R1/R2 Hose

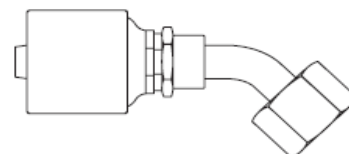

| | |
|------------------|----------------------------|
| STO-MLF-45S-0412 | 1/4 Tail x M12 Light 45° |
| STO-MLF-45S-0414 | 1/4 Tail x M14 Light 45° |
| STO-MLF-45S-0416 | 1/4 Tail x M16 Light 45° |
| STO-MLF-45S-0418 | 1/4 Tail x M18 Light 45° |
| STO-MLF-45S-0516 | 5/16 Tail x M16 Light 45° |
| STO-MLF-45S-0616 | 3/8 Tail x M16 Light 45° |
| STO-MLF-45S-0618 | 3/8 Tail x M18 Light 45° |
| STO-MLF-45S-0622 | 3/8 Tail x M22 Light 45° |
| STO-MLF-45S-0818 | 1/2 Tail x M18 Light 45° |
| STO-MLF-45S-0822 | 1/2 Tail x M22 Light 45° |
| STO-MLF-45S-0826 | 1/2 Tail x M26 Light 45° |
| STO-MLF-45S-1026 | 5/8 Tail x M26 Light 45° |
| STO-MLF-45S-1230 | 3/4 Tail x M30 Light 45° |
| STO-MLF-45S-1636 | 1 Tail x M36 Light 45° |
| STO-MLF-45S-2045 | 1-1/4 Tail x M45 Light 45° |

| | |
|------------------|-------------------------------|
| STO-ORF-45S-0409 | 1/4 Tail x 9/16 ORFS 45° |
| STO-ORF-45S-0411 | 1/4 Tail x 11/16 ORFS 45° |
| STO-ORF-45S-0611 | 3/8 Tail x 11/16 ORFS 45° |
| STO-ORF-45S-0613 | 3/8 Tail x 13/16 ORFS 45° |
| STO-ORF-45S-0811 | 1/2 Tail x 11/16 ORFS 45° |
| STO-ORF-45S-0813 | 1/2 Tail x 13/16 ORFS 45° |
| STO-ORF-45S-0816 | 1/2 Tail x 1 ORFS 45° |
| STO-ORF-45S-0819 | 1/2 Tail x 1-3/16 ORFS 45° |
| STO-ORF-45S-1016 | 5/8 Tail x 1 ORFS 45° |
| STO-ORF-45S-1019 | 5/8 Tail x 1-3/16 ORFS 45° |
| STO-ORF-45S-1216 | 3/4 Tail x 1 ORFS 45° |
| STO-ORF-45S-1219 | 3/4 Tail x 1-3/16 ORFS 45° |
| STO-ORF-45S-1223 | 3/4 Tail x 1-7/16 ORFS 45° |
| STO-ORF-45S-1623 | 1 Tail x 1-7/16 ORFS 45° |
| STO-ORF-45S-2027 | 1-1/4 Tail x 1-11/16 ORFS 45° |



90 Degree Compact R1/R2 Hose

BSPF Female Swivel 90 Degree Compact to R1/R2 Hose

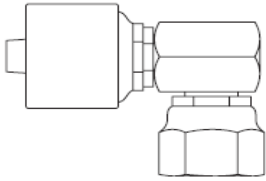

| | |
|------------------|-----------------------------------|
| STO-BSF-90C-0404 | 1/4 Tail x 1/4 BSPPFS 90° Compact |
| STO-BSF-90C-0606 | 3/8 Tail x 3/8 BSPPFS 90° Compact |
| STO-BSF-90C-0608 | 3/8 Tail x 1/2 BSPPFS 90° Compact |
| STO-BSF-90C-0808 | 1/2 Tail x 1/2 BSPPFS 90° Compact |
| STO-BSF-90C-1010 | 5/8 Tail x 5/8 BSPPFS 90° Compact |
| STO-BSF-90C-1212 | 3/4 Tail x 3/4 BSPPFS 90° Compact |
| STO-BSF-90C-1616 | 1 Tail x 1 BSPPFS 90° Compact |

UNO Male Live Swivel 90 Degree Compact to R1/R2 Hose

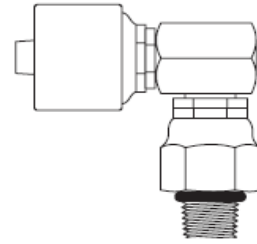

| | |
|------------------|---|
| STO-USM-90C-0812 | 1/2 Tail x 3/4 UNO Male Live Swivel 90° Compact |
| STO-USM-90C-0814 | 1/2 Tail x 7/8 UNO Male Live Swivel 90° Compact |

90 Degree Swept R1/R2 Hose

BSPF Female Swivel 90 Swept to R1/R2 Hose

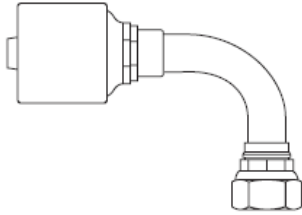

| | |
|------------------|-------------------------------|
| STO-BSF-90S-0404 | 1/4 Tail x 1/4 BSPPFS 90° |
| STO-BSF-90S-0406 | 1/4 Tail x 3/8 BSPPFS 90° |
| STO-BSF-90S-0606 | 3/8 Tail x 3/8 BSPPFS 90° |
| STO-BSF-90S-0608 | 3/8 Tail x 1/2 BSPPFS 90° |
| STO-BSF-90S-0808 | 1/2 Tail x 1/2 BSPPFS 90° |
| STO-BSF-90S-0810 | 1/2 Tail x 5/8 BSPPFS 90° |
| STO-BSF-90S-1010 | 5/8 Tail x 5/8 BSPPFS 90° |
| STO-BSF-90S-1012 | 5/8 Tail x 3/4 BSPPFS 90° |
| STO-BSF-90S-1212 | 3/4 Tail x 3/4 BSPPFS 90° |
| STO-BSF-90S-1216 | 3/4 Tail x 1 BSPPFS 90° |
| STO-BSF-90S-1616 | 1 Tail x 1 BSPPFS 90° |
| STO-BSF-90S-2020 | 1-1/4 Tail x 1-1/4 BSPPFS 90° |

JIC Female Swivel 90 Swept to R1/R2 Hose

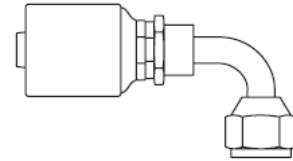

| | |
|-------------------|------------------------------------|
| STO-JIF-90S-0407 | 1/4 Tail x 7/16 JICFS 90° |
| STO-JIF-90S-0407M | 1/4 Tail x 7/16 JICFS 90° Medium |
| STO-JIF-90S-0407L | 1/4 Tail x 7/16 JICFS 90° Long |
| STO-JIF-90S-0408 | 1/4 Tail x 1/2 JICFS 90° |
| STO-JIF-90S-0408M | 1/4 Tail x 1/2 JICFS 90° Medium |
| STO-JIF-90S-0409 | 1/4 Tail x 9/16 JICFS 90° |
| STO-JIF-90S-0409M | 1/4 Tail x 9/16 JICFS 90° Medium |
| STO-JIF-90S-0409L | 1/4 Tail x 9/16 JICFS 90° Long |
| STO-JIF-90S-0609 | 3/8 Tail x 9/16 JICFS 90° |
| STO-JIF-90S-0609M | 3/8 Tail x 9/16 JICFS 90° Medium |
| STO-JIF-90S-0609L | 3/8 Tail x 9/16 JICFS 90° Long |
| STO-JIF-90S-0612 | 3/8 Tail x 3/4 JICFS 90° |
| STO-JIF-90S-0612M | 3/8 Tail x 3/4 JICFS 90° Medium |
| STO-JIF-90S-0612L | 3/8 Tail x 3/4 JICFS 90° Long |
| STO-JIF-90S-0614 | 3/8 Tail x 7/8 JICFS 90° |
| STO-JIF-90S-0812 | 1/2 Tail x 3/4 JICFS 90° |
| STO-JIF-90S-0812M | 1/2 Tail x 3/4 JICFS 90° Medium |
| STO-JIF-90S-0812L | 1/2 Tail x 3/4 JICFS 90° Long |
| STO-JIF-90S-0814 | 1/2 Tail x 7/8 JICFS 90° |
| STO-JIF-90S-0814M | 1/2 Tail x 7/8 JICFS 90° Medium |
| STO-JIF-90S-0814L | 1/2 Tail x 7/8 JICFS 90° Long |
| STO-JIF-90S-0817 | 1/2 Tail x 1-1/16 JICFS 90° |
| STO-JIF-90S-1014 | 5/8 Tail x 7/8 JICFS 90° |
| STO-JIF-90S-1014M | 5/8 Tail x 7/8 JICFS 90° Medium |
| STO-JIF-90S-1014L | 5/8 Tail x 7/8 JICFS 90° Long |
| STO-JIF-90S-1017 | 5/8 Tail x 1-1/16 JICFS 90° |
| STO-JIF-90S-1214 | 3/4 Tail x 7/8 JICFS 90° |
| STO-JIF-90S-1217 | 3/4 Tail x 1-1/16 JICFS 90° |
| STO-JIF-90S-1217M | 3/4 Tail x 1-1/16 JICFS 90° Medium |
| STO-JIF-90S-1217L | 3/4 Tail x 1-1/16 JICFS 90° Long |
| STO-JIF-90S-1219 | 3/4 Tail x 1-3/16 JICFS 90° |
| STO-JIF-90S-1221 | 3/4 Tail x 1-5/16 JICFS 90° |
| STO-JIF-90S-1617 | 1 Tail x 1-1/16 JICFS 90° |
| STO-JIF-90S-1621 | 1 Tail x 1-5/16 JICFS 90° |
| STO-JIF-90S-1621M | 1 Tail x 1-5/16 JICFS 90° Medium |
| STO-JIF-90S-1621L | 1 Tail x 1-5/16 JICFS 90° Long |



Metric Heavy Female Swivel 90 Swept to R1/R2 Hose

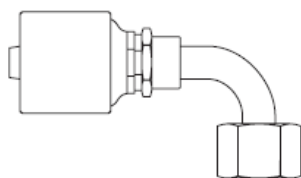

| | |
|------------------|---------------------------|
| STO-MHF-90S-0414 | 1/4 Tail x M14 Heavy 90° |
| STO-MHF-90S-0416 | 1/4 Tail x M16 Heavy 90° |
| STO-MHF-90S-0418 | 1/4 Tail x M18 Heavy 90° |
| STO-MHF-90S-0520 | 5/16 Tail x M20 Heavy 90° |
| STO-MHF-90S-0618 | 3/8 Tail x M18 Heavy 90° |
| STO-MHF-90S-0620 | 3/8 Tail x M20 Heavy 90° |
| STO-MHF-90S-0622 | 3/8 Tail x M22 Heavy 90° |
| STO-MHF-90S-0822 | 1/2 Tail x M22 Heavy 90° |
| STO-MHF-90S-0824 | 1/2 Tail x M24 Heavy 90° |
| STO-MHF-90S-1030 | 5/8 Tail x M30 Heavy 90° |
| STO-MHF-90S-1230 | 3/4 Tail x M30 Heavy 90° |
| STO-MHF-90S-1236 | 3/4 Tail x M36 Heavy 90° |
| STO-MHF-90S-1636 | 1 Tail x M36 Heavy 90° |
| STO-MHF-90S-1642 | 1 Tail x M42 Heavy 90° |

Metric Heavy Female Swivel 90 Swept to R1/R2 Hose

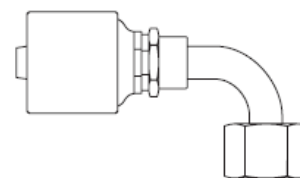

| | |
|------------------|---------------------------|
| STO-MLF-90S-0412 | 1/4 Tail x M12 Light 90° |
| STO-MLF-90S-0414 | 1/4 Tail x M14 Light 90° |
| STO-MLF-90S-0416 | 1/4 Tail x M16 Light 90° |
| STO-MLF-90S-0418 | 1/4 Tail x M18 Light 90° |
| STO-MLF-90S-0516 | 5/16 Tail x M16 Light 90° |
| STO-MLF-90S-0518 | 5/16 Tail x M18 Light 90° |
| STO-MLF-90S-0616 | 3/8 Tail x M16 Light 90° |
| STO-MLF-90S-0618 | 3/8 Tail x M18 Light 90° |
| STO-MLF-90S-0622 | 3/8 Tail x M22 Light 90° |
| STO-MLF-90S-0818 | 1/2 Tail x M18 Light 90° |
| STO-MLF-90S-0822 | 1/2 Tail x M22 Light 90° |
| STO-MLF-90S-0826 | 1/2 Tail x M26 Light 90° |
| STO-MLF-90S-1026 | 5/8 Tail x M26 Light 90° |
| STO-MLF-90S-1226 | 3/4 Tail x M26 Light 90° |
| STO-MLF-90S-1230 | 3/4 Tail x M30 Light 90° |
| STO-MLF-90S-1636 | 1 Tail x M36 Light 90° |

ORFS Female Swivel 90 Degree Swept to R1/R2 Hose

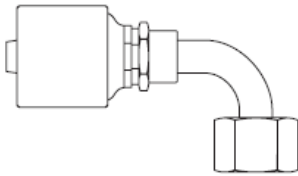

| | |
|-------------------|--------------------------------------|
| STO-ORF-90S-0409 | 1/4 Tail x 9/16 ORFS 90° |
| STO-ORF-90S-0409M | 1/4 Tail x 9/16 ORFS 90° Medium |
| STO-ORF-90S-0409L | 1/4 Tail x 9/16 ORFS 90° Long |
| STO-ORF-90S-0411 | 1/4 Tail x 11/16 ORFS 90° |
| STO-ORF-90S-0411M | 1/4 Tail x 11/16 ORFS 90° Medium |
| STO-ORF-90S-0411L | 1/4 Tail x 11/16 ORFS 90° Long |
| STO-ORF-90S-0413 | 1/4 Tail x 13/16 ORFS 90° |
| STO-ORF-90S-0413L | 1/4 Tail x 13/16 ORFS 90° Long |
| STO-ORF-90S-0611 | 3/8 Tail x 11/16 ORFS 90° |
| STO-ORF-90S-0611M | 3/8 Tail x 11/16 ORFS 90° Medium |
| STO-ORF-90S-0611L | 3/8 Tail x 11/16 ORFS 90° Long |
| STO-ORF-90S-0613 | 3/8 Tail x 13/16 ORFS 90° |
| STO-ORF-90S-0613M | 3/8 Tail x 13/16 ORFS 90° Medium |
| STO-ORF-90S-0613L | 3/8 Tail x 13/16 ORFS 90° Long |
| STO-ORF-90S-0811 | 1/2 Tail x 11/16 ORFS 90° |
| STO-ORF-90S-0813 | 1/2 Tail x 13/16 ORFS 90° |
| STO-ORF-90S-0813M | 1/2 Tail x 13/16 ORFS 90° Medium |
| STO-ORF-90S-0813L | 1/2 Tail x 13/16 ORFS 90° Long |
| STO-ORF-90S-0816 | 1/2 Tail x 1 ORFS 90° |
| STO-ORF-90S-0816M | 1/2 Tail x 1 ORFS 90° Medium |
| STO-ORF-90S-0816L | 1/2 Tail x 1 ORFS 90° Long |
| STO-ORF-90S-0819 | 1/2 Tail x 1-3/16 ORFS 90° |
| STO-ORF-90S-1016 | 5/8 Tail x 1 ORFS 90° |
| STO-ORF-90S-1016M | 5/8 Tail x 1 ORFS 90° Medium |
| STO-ORF-90S-1016L | 5/8 Tail x 1 ORFS 90° Long |
| STO-ORF-90S-1019 | 5/8 Tail x 1-3/16 ORFS 90° |
| STO-ORF-90S-1216 | 3/4 Tail x 1 ORFS 90° |
| STO-ORF-90S-1219 | 3/4 Tail x 1-3/16 ORFS 90° |
| STO-ORF-90S-1219M | 3/4 Tail x 1-3/16 ORFS 90° Medium |
| STO-ORF-90S-1219L | 3/4 Tail x 1-3/16 ORFS 90° Long |
| STO-ORF-90S-1223 | 3/4 Tail x 1-7/16 ORFS 90° |
| STO-ORF-90S-1623 | 1 Tail x 1-7/16 ORFS 90° |
| STO-ORF-90S-1623M | 1 Tail x 1-7/16 ORFS 90° Medium |
| STO-ORF-90S-1623L | 1 Tail x 1-7/16 ORFS 90° Long |
| STO-ORF-90S-2027 | 1-1/4 Tail x 1-11/16 ORFS 90° |
| STO-ORF-90S-2027M | 1-1/4 Tail x 1-11/16 ORFS 90° Medium |



Straight Multi Spiral Hose

BSPM Male to Multi Spiral Hose (-8 to -20 Two Piece)

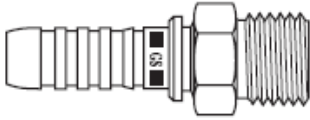

| | |
|--------------|--------------------------------------|
| STM-BPM-0808 | 1/2 Tail x 1/2 BSPPM Multispiral |
| STM-BPM-1212 | 3/4 Tail x 3/4 BSPPM Multispiral |
| STM-BPM-1216 | 3/4 Tail x 1 BSPPM Multispiral |
| STM-BPM-1616 | 1 Tail x 1 BSPPM Multispiral |
| STM-BPM-2020 | 1-1/4 Tail x 1-1/4 BSPPM Multispiral |

Caterpillar Flange to Multi Spiral Hose (-12 to -20 Two Piece)

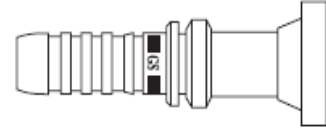

| | |
|--------------|---|
| STM-CAT-1212 | 3/4 Tail x 3/4 CAT Flange Multispiral |
| STM-CAT-1616 | 1 Tail x 1 CAT Flange Multispiral |
| STM-CAT-2020 | 1-1/4 Tail x 1-1/4 CAT Flange Multispiral |

BSPM Female Swivel to Multi Spiral Hose (-8 to -20 Two Piece)

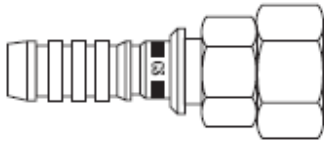

| | |
|--------------|--------------------------------------|
| STM-BSF-0606 | 3/8 Tail x 3/8 BSPFS Multispiral |
| STM-BSF-0608 | 3/8 Tail x 1/2 BSPFS Multispiral |
| STM-BSF-0808 | 1/2 Tail x 1/2 BSPFS Multispiral |
| STM-BSF-0812 | 1/2 Tail x 3/4 BSPFS Multispiral |
| STM-BSF-1010 | 5/8 Tail x 5/8 BSPFS Multispiral |
| STM-BSF-1012 | 5/8 Tail x 3/4 BSPFS Multispiral |
| STM-BSF-1212 | 3/4 Tail x 3/4 BSPFS Multispiral |
| STM-BSF-1216 | 3/4 Tail x 1 BSPFS Multispiral |
| STM-BSF-1616 | 1 Tail x 1 BSPFS Multispiral |
| STM-BSF-1620 | 1 Tail x 1-1/4 BSPFS Multispiral |
| STM-BSF-2020 | 1-1/4 Tail x 1-1/4 BSPFS Multispiral |

SAE Code 61 Flange to Multi Spiral Hose (-8 to -20 Two Piece)

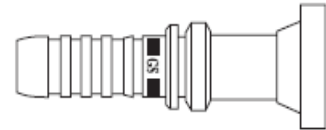

| | |
|--------------|---|
| STM-F61-0808 | 1/2 Tail x 1/2 C61 Flange Multispiral |
| STM-F61-0812 | 1/2 Tail x 3/4 C61 Flange Multispiral |
| STM-F61-0816 | 1/2 Tail x 1 C61 Flange Multispiral |
| STM-F61-1012 | 5/8 Tail x 3/4 C61 Flange Multispiral |
| STM-F61-1212 | 3/4 Tail x 3/4 C61 Flange Multispiral |
| STM-F61-1216 | 3/4 Tail x 1 C61 Flange Multispiral |
| STM-F61-1220 | 3/4 Tail x 1-1/4 C61 Flange Multispiral |
| STM-F61-1616 | 1 Tail x 1 C61 Flange Multispiral |
| STM-F61-1620 | 1 Tail x 1-1/4 C61 Flange Multispiral |
| STM-F61-1624 | 1 Tail x 1-1/2 C61 Flange Multispiral |
| STM-F61-2016 | 1-1/4 Tail x 1 C61 Flange Multispiral |
| STM-F61-2020 | 1-1/4 Tail x 1-1/4 C61 Flange Multispiral |
| STM-F61-2024 | 1-1/4 Tail x 1-1/2 C61 Flange Multispiral |
| STM-F61-2032 | 1-1/4 Tail x 2 C61 Flange Multispiral |

BSPM Female Swivel to Multi Spiral Hose (-24 to -32 One Piece)

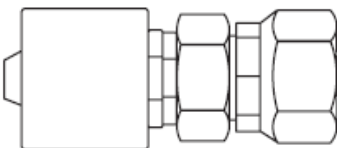

| | |
|---------------|--------------------------------------|
| STMO-BSF-2424 | 1-1/2 Tail x 1-1/2 BSPFS Multispiral |
| STMO-BSF-3232 | 2 Tail x 2 BSPFS Multispiral |

SAE Code 61 Flange to Multi Spiral Hose (-24 to -32 One Piece)

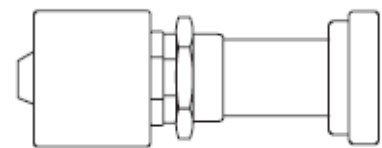

| | |
|---------------|---|
| STMO-F61-2424 | 1-1/2 Tail x 1-1/2 C61 Flange Multispiral |
| STMO-F61-2432 | 1-1/2 Tail x 2 C61 Flange Multispiral |
| STMO-F61-3232 | 2 Tail x 2 C61 Flange Multispiral |

**SAE Code 62 Flange to Multi Spiral Hose
(-8 to -20 Two Piece)**

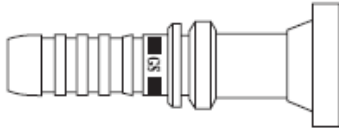

| | |
|--------------|---|
| STM-F62-0808 | 1/2 Tail x 1/2 C62 Flange Multispiral |
| STM-F62-0812 | 1/2 Tail x 3/4 C62 Flange Multispiral |
| STM-F62-1212 | 3/4 Tail x 3/4 C62 Flange Multispiral |
| STM-F62-1216 | 3/4 Tail x 1 C62 Flange Multispiral |
| STM-F62-1616 | 1 Tail x 1 C62 Flange Multispiral |
| STM-F62-1620 | 1 Tail x 1-1/4 C62 Flange Multispiral |
| STM-F62-2016 | 1-1/4 Tail x 1 C62 Flange Multispiral |
| STM-F62-2020 | 1-1/4 Tail x 1-1/4 C62 Flange Multispiral |
| STM-F62-2024 | 1-1/4 Tail x 1-1/2 C62 Flange Multispiral |

**JIC Female Swivel to Multi Spiral Hose
(-8 to -20 Two Piece)**

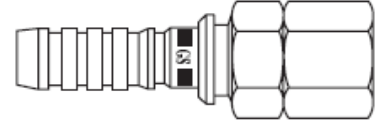

| | |
|--------------|---------------------------------------|
| STM-JIF-0609 | 3/8 Tail x 9/16 JICFS Multispiral |
| STM-JIF-0612 | 3/8 Tail x 3/4 JICFS Multispiral |
| STM-JIF-0812 | 1/2 Tail x 3/4 JICFS Multispiral |
| STM-JIF-0814 | 1/2 Tail x 7/8 JICFS Multispiral |
| STM-JIF-0817 | 1/2 Tail x 1-1/16 JICFS Multispiral |
| STM-JIF-1014 | 5/8 Tail x 7/8 JICFS Multispiral |
| STM-JIF-1017 | 5/8 Tail x 1-1/16 JICFS Multispiral |
| STM-JIF-1214 | 3/4 Tail x 7/8 JICFS Multispiral |
| STM-JIF-1217 | 3/4 Tail x 1-1/16 JICFS Multispiral |
| STM-JIF-1219 | 3/4 Tail x 1-3/16 JICFS Multispiral |
| STM-JIF-1221 | 3/4 Tail x 1-5/16 JICFS Multispiral |
| STM-JIF-1617 | 1 Tail x 1-1/16 JICFS Multispiral |
| STM-JIF-1621 | 1 Tail x 1-5/16 JICFS Multispiral |
| STM-JIF-1626 | 1 Tail x 1-5/8 JICFS Multispiral |
| STM-JIF-2021 | 1-1/4 Tail x 1-5/16 JICFS Multispiral |
| STM-JIF-2026 | 1-1/4 Tail x 1-5/8 JICFS Multispiral |
| STM-JIF-2030 | 1-1/4 Tail x 1-7/8 JICFS Multispiral |

**SAE Code 62 Flange to Multi Spiral Hose
(-24 to -32 One Piece)**

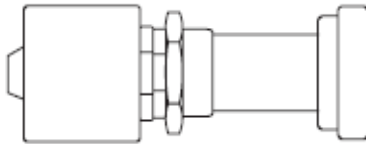

| | |
|---------------|---|
| STMO-F62-2420 | 1-1/2 Tail x 1-1/4 C62 Flange Multispiral |
| STMO-F62-2424 | 1-1/2 Tail x 1-1/2 C62 Flange Multispiral |
| STMO-F62-2432 | 1-1/2 Tail x 2 C62 Flange Multispiral |
| STMO-F62-3224 | 2 Tail x 1-1/2 C62 Flange Multispiral |
| STMO-F62-3232 | 2 Tail x 2 C62 Flange Multispiral |

**JIC Female Swivel to Multi Spiral Hose
(-24 to -32 One Piece)**

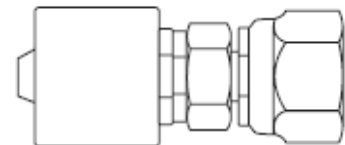

| | |
|---------------|--------------------------------------|
| STMO-JIF-2430 | 1-1/2 Tail x 1-7/8 JICFS Multispiral |
| STMO-JIF-3240 | 2 Tail x 2-1/2 JICFS Multispiral |



**JIC Male to Multi Spiral Hose
(-8 to -20 Two Piece)**

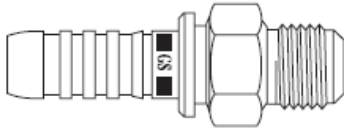

| | |
|--------------|-------------------------------------|
| STM-JIM-0812 | 1/2 Tail x 3/4 JICM Multispiral |
| STM-JIM-0814 | 1/2 Tail x 7/8 JICM Multispiral |
| STM-JIM-1014 | 5/8 Tail x 7/8 JICM Multispiral |
| STM-JIM-1017 | 5/8 Tail x 1-1/16 JICM Multispiral |
| STM-JIM-1217 | 3/4 Tail x 1-1/16 JICM Multispiral |
| STM-JIM-1219 | 3/4 Tail x 1-3/16 JICM Multispiral |
| STM-JIM-1221 | 3/4 Tail x 1-5/16 JICM Multispiral |
| STM-JIM-1621 | 1 Tail x 1-5/16 JICM Multispiral |
| STM-JIM-1626 | 1 Tail x 1-5/8 JICM Multispiral |
| STM-JIM-2026 | 1-1/4 Tail x 1-5/8 JICM Multispiral |

**JIC Male to Multi Spiral Hose
(-24 to -32 One Piece)**

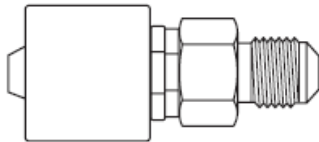

| | |
|---------------|-------------------------------------|
| STMO-JIM-2430 | 1-1/2 Tail x 1-7/8 JICM Multispiral |
| STMO-JIM-3240 | 2 Tail x 2-1/2 JICM Multispiral |

**Metric Heavy Female to Multi Spiral Hose
(-8 to -20 Two Piece)**

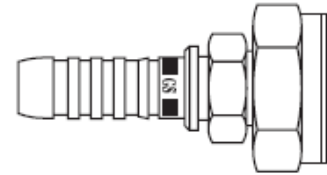

| | |
|--------------|---|
| STM-MHF-0824 | 1/2 Tail x M24 Heavy Female Multispiral |
| STM-MHF-1030 | 5/8 Tail x M30 Heavy Female Multispiral |
| STM-MHF-1230 | 3/4 Tail x M30 Heavy Female Multispiral |
| STM-MHF-1236 | 3/4 Tail x M36 Heavy Female Multispiral |
| STM-MHF-1636 | 1 Tail x M36 Heavy Female Multispiral |
| STM-MHF-1642 | 1 Tail x M42 Heavy Female Multispiral |
| STM-MHF-2052 | 1-1/4 Tail x M52 Heavy Female Multispiral |

**Metric Heavy Female to Multi Spiral Hose
(-24 One Piece)**

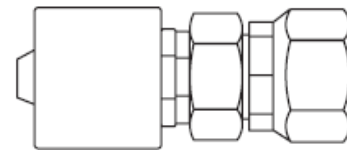

| | |
|---------------|---|
| STMO-MHF-2452 | 1-1/2 Tail x M52 Heavy Female Multispiral |
|---------------|---|

**Metric Light Female to Multi Spiral Hose
(-8 to -20 Two Piece)**



| | |
|--------------|---|
| STM-MLF-0822 | 1/2 Tail x M22 Light Female Multispiral |
| STM-MLF-1026 | 5/8 Tail x M26 Light Female Multispiral |
| STM-MLF-1230 | 3/4 Tail x M30 Light Female Multispiral |
| STM-MLF-1236 | 3/4 Tail x M36 Light Female Multispiral |
| STM-MLF-1636 | 1 Tail x M36 Light Female Multispiral |
| STM-MLF-2045 | 1-1/4 Tail x M45 Light Female Multispiral |

**ORFS Female Swivel to Multi Spiral Hose
(-8 to -20 Two Piece)**

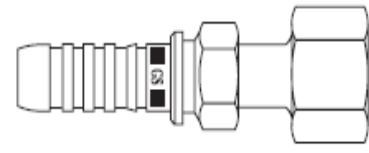

| | |
|--------------|---------------------------------------|
| STM-ORF-0813 | 1/2 Tail x 13/16 ORFS Multispiral |
| STM-ORF-0816 | 1/2 Tail x 1 ORFS Multispiral |
| STM-ORF-1016 | 1 Tail x 1 ORFS Multispiral |
| STM-ORF-1019 | 1 Tail x 1-3/16 ORFS Multispiral |
| STM-ORF-1216 | 3/4 Tail x 1 ORFS Multispiral |
| STM-ORF-1219 | 3/4 Tail x 1-3/16 ORFS Multispiral |
| STM-ORF-1223 | 3/4 Tail x 1-7/16 ORFS Multispiral |
| STM-ORF-1619 | 1 Tail x 1-3/16 ORFS Multispiral |
| STM-ORF-1623 | 1 Tail x 1-7/16 ORFS Multispiral |
| STM-ORF-1627 | 1 Tail x 1-11/16 ORFS Multispiral |
| STM-ORF-2027 | 1-1/4 Tail x 1-11/16 ORFS Multispiral |
| STM-ORF-2032 | 1-1/4 Tail x 2 ORFS Multispiral |

**NPT Male to Multi Spiral Hose
(-12 to -20 Two Piece)**

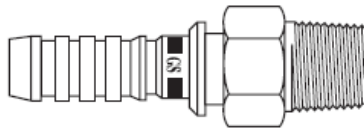

| | |
|--------------|-------------------------------------|
| STM-NTM-0808 | 1/2 Tail x 1/2 NPTM Multispiral |
| STM-NTM-1212 | 3/4 Tail x 3/4 NPTM Multispiral |
| STM-NTM-1616 | 1 Tail x 1 NPTM Multispiral |
| STM-NTM-2020 | 1-1/4 Tail x 1-1/4 NPTM Multispiral |

**ORFS Female Swivel to Multi Spiral Hose
(-24 One Piece)**

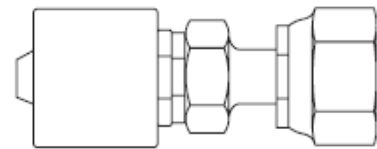

| | |
|---------------|---------------------------------|
| STMO-ORF-2432 | 1-1/2 Tail x 2 ORFS Multispiral |
|---------------|---------------------------------|

**NPT Male to Multi Spiral Hose
(-24 to -32 One Piece)**

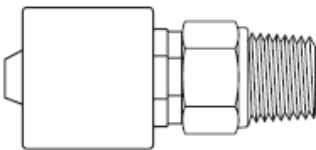

| | |
|---------------|-------------------------------------|
| STMO-NTM-2424 | 1-1/2 Tail x 1-1/2 NPTM Multispiral |
| STMO-NTM-3232 | 2 Tail x 2 NPTM Multispiral |



45 Degree Swept Multi Spiral Hose

BSPF Female Swivel 45 Swept to Multi Spiral Hose (-8 to -20 Two Piece)

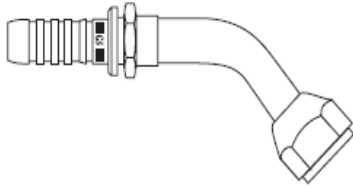

| | |
|------------------|------------------------------|
| STM-BSF-45S-0808 | 1/2 Tail x 1/2 BSPFS 45° |
| STM-BSF-45S-1010 | 5/8 Tail x 5/8 BSPFS 45° |
| STM-BSF-45S-1212 | 3/4 Tail x 3/4 BSPFS 45° |
| STM-BSF-45S-1616 | 1 Tail x 1 BSPFS 45° |
| STM-BSF-45S-2020 | 1-1/4 Tail x 1-1/4 BSPFS 45° |

BSPF Female Swivel 45 Swept to Multi Spiral Hose (-24 to -32 One Piece)

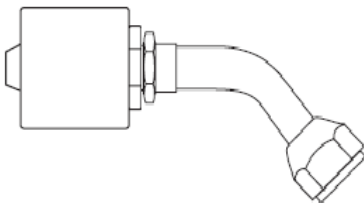

| | |
|-------------------|------------------------------|
| STMO-BSF-45S-2424 | 1-1/2 Tail x 1-1/2 BSPFS 45° |
| STMO-BSF-45S-3232 | 2 Tail x 2 BSPFS 45° |

SAE Code 61 Flange 45 Degree Swept to Multi Spiral Hose (-8 to -20 Two Piece)

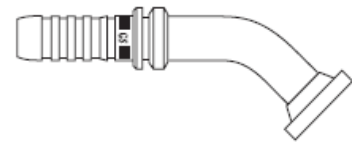

| | |
|------------------|-----------------------------------|
| STM-F61-45S-0808 | 1/2 Tail x 1/2 C61 Flange 45° |
| STM-F61-45S-0812 | 1/2 Tail x 3/4 C61 Flange 45° |
| STM-F61-45S-1012 | 5/8 Tail x 3/4 C61 Flange 45° |
| STM-F61-45S-1212 | 3/4 Tail x 3/4 C61 Flange 45° |
| STM-F61-45S-1216 | 3/4 Tail x 1 C61 Flange 45° |
| STM-F61-45S-1616 | 1 Tail x 1 C61 Flange 45° |
| STM-F61-45S-1620 | 1 Tail x 1-1/4 C61 Flange 45° |
| STM-F61-45S-2016 | 1-1/4 Tail x 1 C61 Flange 45° |
| STM-F61-45S-2020 | 1-1/4 Tail x 1-1/4 C61 Flange 45° |
| STM-F61-45S-2024 | 1-1/4 Tail x 1-1/2 C61 Flange 45° |

SAE Code 61 Flange 45 Degree Swept to Multi Spiral Hose (-24 to -32 One Piece)

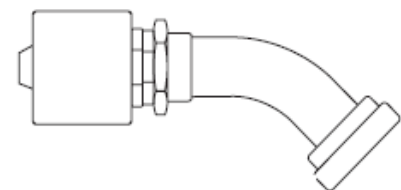

| | |
|-------------------|-----------------------------------|
| STMO-F61-45S-2424 | 1-1/2 Tail x 1-1/2 C61 Flange 45° |
| STMO-F61-45S-2432 | 1-1/2 Tail x 2 C61 Flange 45° |
| STMO-F61-45S-3232 | 2 Tail x 2 C61 Flange 45° |

SAE Code 62 Flange 45 Degree Swept to Multi Spiral Hose (-8 to -20 Two Piece)

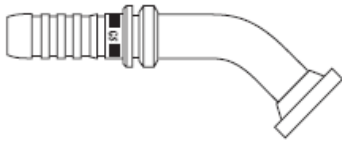

| | |
|------------------|-----------------------------------|
| STM-F62-45S-0808 | 1/2 Tail x 1/2 C62 Flange 45° |
| STM-F62-45S-0812 | 1/2 Tail x 3/4 C62 Flange 45° |
| STM-F62-45S-1012 | 5/8 Tail x 3/4 C62 Flange 45° |
| STM-F62-45S-1212 | 3/4 Tail x 3/4 C62 Flange 45° |
| STM-F62-45S-1216 | 3/4 Tail x 1 C62 Flange 45° |
| STM-F62-45S-1612 | 1 Tail x 3/4 C62 Flange 45° |
| STM-F62-45S-1616 | 1 Tail x 1 C62 Flange 45° |
| STM-F62-45S-1620 | 1 Tail x 1-1/4 C62 Flange 45° |
| STM-F62-45S-2016 | 1-1/4 Tail x 1 C62 Flange 45° |
| STM-F62-45S-2020 | 1-1/4 Tail x 1-1/4 C62 Flange 45° |
| STM-F62-45S-2024 | 1-1/4 Tail x 1-1/2 C62 Flange 45° |

JIC Female Swivel 45 Degree Swept to Multi Spiral Hose (-8 to -20 Two Piece)

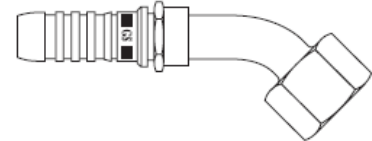

| | |
|------------------|------------------------------|
| STM-JIF-45S-0812 | 1/2 Tail x 3/4 JICFS 45° |
| STM-JIF-45S-0814 | 1/2 Tail x 7/8 JICFS 45° |
| STM-JIF-45S-1014 | 5/8 Tail x 7/8 JICFS 45° |
| STM-JIF-45S-1017 | 5/8 Tail x 1-1/16 JICFS 45° |
| STM-JIF-45S-1217 | 3/4 Tail x 1-1/16 JICFS 45° |
| STM-JIF-45S-1221 | 3/4 Tail x 1-5/16 JICFS 45° |
| STM-JIF-45S-1621 | 1 Tail x 1-5/16 JICFS 45° |
| STM-JIF-45S-1626 | 1 Tail x 1-5/8 JICFS 45° |
| STM-JIF-45S-2026 | 1-1/4 Tail x 1-5/8 JICFS 45° |

SAE Code 62 Flange 45 Degree Swept to Multi Spiral Hose (-24 to -32 One Piece)

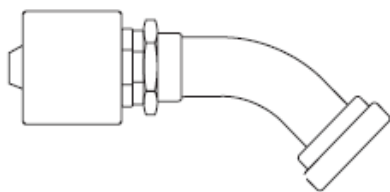

| | |
|-------------------|-----------------------------------|
| STMO-F62-45S-2424 | 1-1/2 Tail x 1-1/2 C62 Flange 45° |
| STMO-F62-45S-2432 | 1-1/2 Tail x 2 C62 Flange 45° |
| STMO-F62-45S-3232 | 2 Tail x 2 C62 Flange 45° |

JIC Female Swivel 45 Degree Swept to Multi Spiral Hose (-24 One Piece)

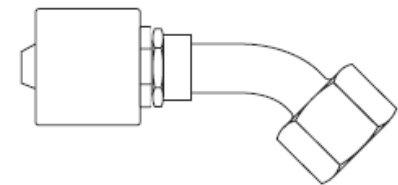

| | |
|-------------------|------------------------------|
| STMO-JIF-45S-2430 | 1-1/2 Tail x 1-7/8 JICFS 45° |
|-------------------|------------------------------|

Metric Heavy Female 45 Degree Swept to Multi Spiral Hose (-8 to -20 Two Piece)

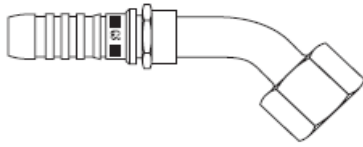

| | |
|------------------|-----------------------------------|
| STM-MHF-45S-0824 | 1/2 Tail x M24 Heavy Female 45° |
| STM-MHF-45S-1030 | 5/8 Tail x M30 Heavy Female 45° |
| STM-MHF-45S-1230 | 3/4 Tail x M30 Heavy Female 45° |
| STM-MHF-45S-1236 | 3/4 Tail x M36 Heavy Female 45° |
| STM-MHF-45S-1636 | 1 Tail x M36 Heavy Female 45° |
| STM-MHF-45S-1642 | 1 Tail x M42 Heavy Female 45° |
| STM-MHF-45S-2052 | 1-1/4 Tail x M52 Heavy Female 45° |

ORFS Female Swivel 45 Degree Swept to Multi Spiral Hose (-8 to -20 Two Piece)

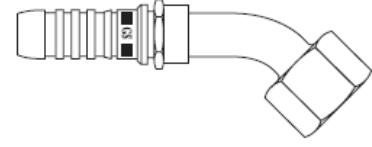

| | |
|------------------|-------------------------------|
| STM-ORF-45S-0813 | 1/2 Tail x 13/16 ORFS 45° |
| STM-ORF-45S-0816 | 1/2 Tail x 1 ORFS 45° |
| STM-ORF-45S-1016 | 5/8 Tail x 1 ORFS 45° |
| STM-ORF-45S-1219 | 3/4 Tail x 1-3/16 ORFS 45° |
| STM-ORF-45S-1223 | 3/4 Tail x 1-7/16 ORFS 45° |
| STM-ORF-45S-1623 | 1 Tail x 1-7/16 ORFS 45° |
| STM-ORF-45S-1627 | 1 Tail x 1-11/16 ORFS 45° |
| STM-ORF-45S-2027 | 1-1/4 Tail x 1-11/16 ORFS 45° |

Metric Heavy Female 45 Degree Swept to Multi Spiral Hose (-24 One Piece)

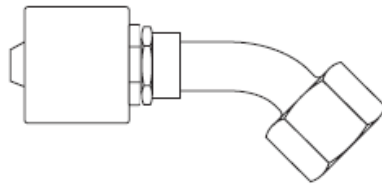

| | |
|-------------------|-----------------------------------|
| STMO-MHF-45S-2452 | 1-1/2 Tail x M52 Heavy Female 45° |
|-------------------|-----------------------------------|

ORFS Female Swivel 45 Degree Swept to Multi Spiral Hose (-24 One Piece)

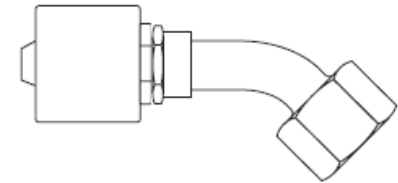

| | |
|-------------------|---------------------------|
| STMO-ORF-45S-2432 | 1-1/2" Tail x 2" ORFS 45° |
|-------------------|---------------------------|



90 Degree Swept Multi Spiral Hose

BSPF Female Swivel 90 Swept to Multi Spiral Hose (-8 to -20 Two Piece)

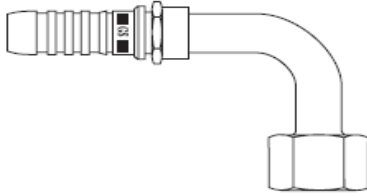

| | |
|------------------|------------------------------|
| STM-BSF-90S-0808 | 1/2 Tail x 1/2 BSPFS 90° |
| STM-BSF-90S-1212 | 3/4 Tail x 3/4 BSPFS 90° |
| STM-BSF-90S-1616 | 1 Tail x 1 BSPFS 90° |
| STM-BSF-90S-2020 | 1-1/4 Tail x 1-1/4 BSPFS 90° |

BSPF Female Swivel 90 Swept to Multi Spiral Hose (-24 to -32 One Piece)

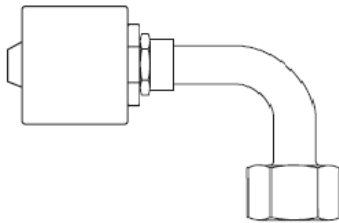

| | |
|-------------------|------------------------------|
| STMO-BSF-90S-2424 | 1-1/2 Tail x 1-1/2 BSPFS 90° |
| STMO-BSF-90S-3232 | 2 Tail x 2 BSPFS 90° |

Caterpillar Flange 90 Degree Swept to Multi Spiral Hose (-8 to -20 Two Piece)

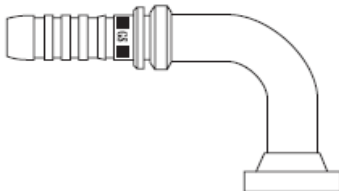

| | |
|------------------|-----------------------------------|
| STM-CAT-90S-1212 | 3/4 Tail x 3/4 CAT Flange 90° |
| STM-CAT-90S-1216 | 3/4 Tail x 1 CAT Flange 90° |
| STM-CAT-90S-1616 | 1 Tail x 1 CAT Flange 90° |
| STM-CAT-90S-1620 | 1 Tail x 1-1/4 CAT Flange 90° |
| STM-CAT-90S-2020 | 1-1/4 Tail x 1-1/4 CAT Flange 90° |
| STM-CAT-90S-2024 | 1-1/4 Tail x 1-1/2 CAT Flange 90° |

SAE Code 61 Flange 90 Degree Swept to Multi Spiral Hose (-8 to -20 Two Piece)

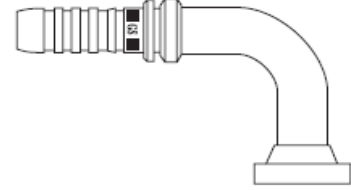

| | |
|------------------|-----------------------------------|
| STM-F61-90S-0808 | 1/2 Tail x 1/2 C61 Flange 90° |
| STM-F61-90S-0812 | 1/2 Tail x 3/4 C61 Flange 90° |
| STM-F61-90S-1212 | 3/4 Tail x 3/4 C61 Flange 90° |
| STM-F61-90S-1216 | 3/4 Tail x 1 C61 Flange 90° |
| STM-F61-90S-1220 | 3/4 Tail x 1-1/4 C61 Flange 90° |
| STM-F61-90S-1616 | 1 Tail x 1 C61 Flange 90° |
| STM-F61-90S-1620 | 1 Tail x 1-1/4 C61 Flange 90° |
| STM-F61-90S-1624 | 1 Tail x 1-1/2 C61 Flange 90° |
| STM-F61-90S-2020 | 1-1/4 Tail x 1-1/4 C61 Flange 90° |
| STM-F61-90S-2024 | 1-1/4 Tail x 1-1/2 C61 Flange 90° |

SAE Code 61 Flange 90 Degree Swept to Multi Spiral Hose (-24 to -32 One Piece)

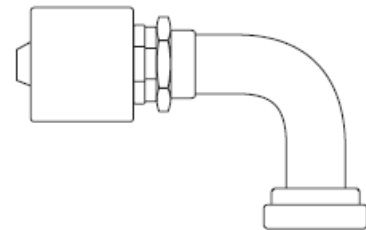

| | |
|-------------------|-----------------------------------|
| STMO-F61-90S-2424 | 1-1/2 Tail x 1-1/2 C61 Flange 90° |
| STMO-F61-90S-3232 | 2 Tail x 2 C61 Flange 90° |

SAE Code 62 Flange 90 Degree Swept to Multi Spiral Hose (-8 to -20 Two Piece)

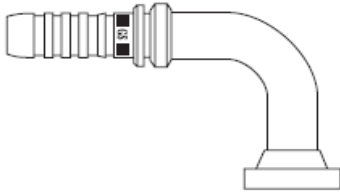

| | |
|------------------|-----------------------------------|
| STM-F62-90S-1212 | 3/4 Tail x 3/4 C62 Flange 90° |
| STM-F62-90S-1216 | 3/4 Tail x 1 C62 Flange 90° |
| STM-F62-90S-1612 | 1 Tail x 3/4 C62 Flange 90° |
| STM-F62-90S-1616 | 1 Tail x 1 C62 Flange 90° |
| STM-F62-90S-1620 | 1 Tail x 1-1/4 C62 Flange 90° |
| STM-F62-90S-1624 | 1 Tail x 1-1/2 C62 Flange 90° |
| STM-F62-90S-2016 | 1-1/4 Tail x 1 C62 Flange 90° |
| STM-F62-90S-2020 | 1-1/4 Tail x 1-1/4 C62 Flange 90° |
| STM-F62-90S-2024 | 1-1/4 Tail x 1-1/2 C62 Flange 90° |

JIC Female Swivel 90 Degree Swept to Multi Spiral Hose (-8 to -20 Two Piece)

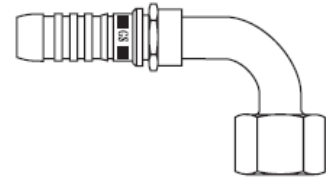

| | |
|------------------|------------------------------|
| STM-JIF-90S-0812 | 1/2 Tail x 3/4 JICFS 90° |
| STM-JIF-90S-0814 | 1/2 Tail x 7/8 JICFS 90° |
| STM-JIF-90S-0817 | 1/2 Tail x 1-1/16 JICFS 90° |
| STM-JIF-90S-1014 | 5/8 Tail x 7/8 JICFS 90° |
| STM-JIF-90S-1017 | 5/8 Tail x 1-1/16 JICFS 90° |
| STM-JIF-90S-1217 | 3/4 Tail x 1-1/16 JICFS 90° |
| STM-JIF-90S-1221 | 3/4 Tail x 1-5/16 JICFS 90° |
| STM-JIF-90S-1621 | 1 Tail x 1-5/16 JICFS 90° |
| STM-JIF-90S-1626 | 1 Tail x 1-5/8 JICFS 90° |
| STM-JIF-90S-2026 | 1-1/4 Tail x 1-5/8 JICFS 90° |

SAE Code 62 Flange 90 Degree Swept to Multi Spiral Hose (-24 to -32 One Piece)

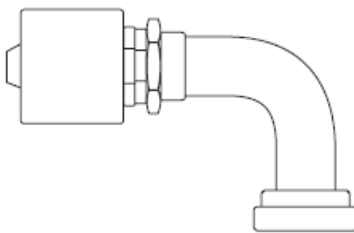

| | |
|-------------------|-----------------------------------|
| STMO-F62-90S-2424 | 1-1/2 Tail x 1-1/2 C62 Flange 90° |
| STMO-F62-90S-2432 | 1-1/2 Tail x 2 C62 Flange 90° |
| STMO-F62-90S-3232 | 2 Tail x 2 C62 Flange 90° |

JIC Female Swivel 90 Degree Swept to Multi Spiral Hose (-24 One Piece)

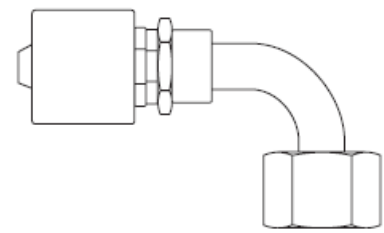

| | |
|-------------------|------------------------------|
| STMO-JIF-90S-2430 | 1-1/2 Tail x 1-7/8 JICFS 90° |
|-------------------|------------------------------|



Metric Heavy Female 90 Degree Swept to Multi Spiral Hose (-8 to -20 Two Piece)

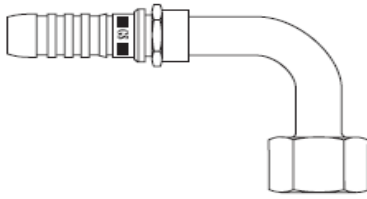

| | |
|------------------|-----------------------------------|
| STM-MHF-90S-0824 | 1/2 Tail x M24 Heavy Female 90° |
| STM-MHF-90S-1030 | 5/8 Tail x M30 Heavy Female 90° |
| STM-MHF-90S-1230 | 3/4 Tail x M30 Heavy Female 90° |
| STM-MHF-90S-1236 | 3/4 Tail x M36 Heavy Female 90° |
| STM-MHF-90S-1636 | 1 Tail x M36 Heavy Female 90° |
| STM-MHF-90S-1642 | 1 Tail x M42 Heavy Female 90° |
| STM-MHF-90S-2052 | 1-1/4 Tail x M52 Heavy Female 90° |

Metric Light Female 90 Degree Swept to Multi Spiral Hose (-8 to -16 Two Piece)

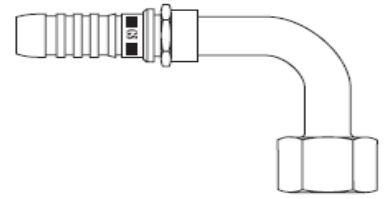

| | |
|------------------|---------------------------------|
| STM-MLF-90S-0822 | 1/2 Tail x M22 Light Female 90° |
| STM-MLF-90S-1026 | 5/8 Tail x M26 Light Female 90° |
| STM-MLF-90S-1230 | 3/4 Tail x M30 Light Female 90° |
| STM-MLF-90S-1636 | 1 Tail x M36 Light Female 90° |

Metric Heavy Female 90 Degree Swept to Multi Spiral Hose (-24 One Piece)

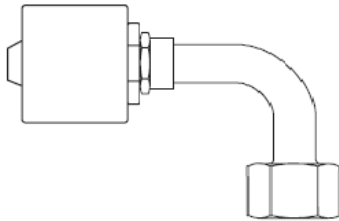

| | |
|-------------------|-----------------------------------|
| STMO-MHF-90S-2452 | 1-1/2 Tail x M52 Heavy Female 90° |
|-------------------|-----------------------------------|

ORFS Female Swivel 90 Degree Swept to Multi Spiral Hose (-8 to -16 Two Piece)

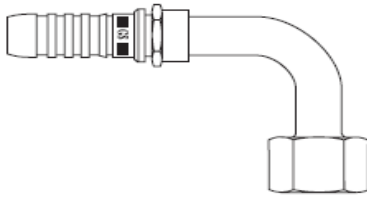

| | |
|------------------|-------------------------------|
| STM-ORF-90S-0813 | 1/2 Tail x 13/16 ORFS 90° |
| STM-ORF-90S-0816 | 1/2 Tail x 1 ORFS 90° |
| STM-ORF-90S-1016 | 5/8 Tail x 1 ORFS 90° |
| STM-ORF-90S-1019 | 5/8 Tail x 1-3/16 ORFS 90° |
| STM-ORF-90S-1216 | 3/4 Tail x 1 ORFS 90° |
| STM-ORF-90S-1219 | 3/4 Tail x 1-3/16 ORFS 90° |
| STM-ORF-90S-1223 | 3/4 Tail x 1-7/16 ORFS 90° |
| STM-ORF-90S-1623 | 1 Tail x 1-7/16 ORFS 90° |
| STM-ORF-90S-1627 | 1 Tail x 1-11/16 ORFS 90° |
| STM-ORF-90S-2027 | 1-1/4 Tail x 1-11/16 ORFS 90° |

ORFS Female Swivel 90 Degree Swept to Multi Spiral Hose (-24 One Piece)

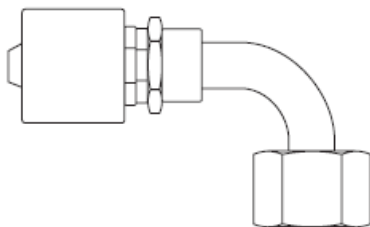

| | |
|-------------------|-------------------------|
| STMO-ORF-90S-2432 | 1-1/2 Tail x 2 ORFS 90° |
|-------------------|-------------------------|

Ferrules

Ferrule for SAE 100R1AT / EN853 Hose

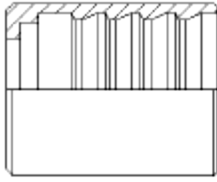

| | |
|---------|-------------------------------|
| SN01-04 | 1/4 Swage Ferrule - R1T Hose |
| SN01-05 | 5/16 Swage Ferrule - R1T Hose |
| SN01-06 | 3/8 Swage Ferrule - R1T Hose |
| SN01-08 | 1/2 Swage Ferrule - R1T Hose |
| SN01-10 | 5/8 Swage Ferrule - R1T Hose |
| SN01-12 | 3/4 Swage Ferrule - R1T Hose |
| SN01-16 | 1 Swage Ferrule - R1T Hose |
| SN01-20 | 1-1/4 Swage Ferrule -R1T Hose |
| SN01-24 | 1-1/2 Swage Ferrule -R1T Hose |
| SN01-32 | 2 Swage Ferrule - R1T Hose |

Ferrule for SAE R1AT & R2AT / EN853 Hose Dual Purpose

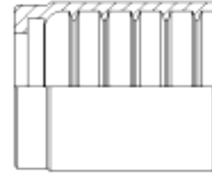

| | |
|------------|------------------------------------|
| SN02-04(N) | 1/4 Swage Ferrule - Dual Purpose |
| SN02-05(N) | 5/16 Swage Ferrule - Dual Purpose |
| SN02-06(N) | 3/8 Swage Ferrule - Dual Purpose |
| SN02-08(N) | 1/2 Swage Ferrule - Dual Purpose |
| SN02-10(N) | 5/8 Swage Ferrule - Dual Purpose |
| SN02-12(N) | 3/4 Swage Ferrule - Dual Purpose |
| SN02-16(N) | 1 Swage Ferrule - Dual Purpose |
| SN02-20(N) | 1-1/4 Swage ferrule - Dual Purpose |
| SN02-24(N) | 1-1/2 Swage Ferrule - Dual Purpose |
| SN02-32(N) | 2 Swage Ferrule - Dual Purpose |

Ferrule for SAE 100R14 Teflon Hose



| | |
|-------|---------------------|
| ST-03 | 3/16 Teflon Ferrule |
| ST-04 | 1/4 Teflon Ferrule |
| ST-05 | 5/16 Teflon Ferrule |
| ST-06 | 3/8 Teflon Ferrule |
| ST-08 | 1/2 Teflon Ferrule |
| ST-10 | 5/8 Teflon Ferrule |
| ST-12 | 3/4 Teflon Ferrule |
| ST-16 | 1 Teflon Ferrule |

Ferrule for SAE 100R7 Hose

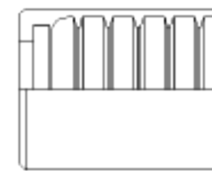

| | |
|---------|------------------------------|
| SN07-02 | 1/8 Swage Ferrule - R7 Hose |
| SN07-03 | 3/16 Swage Ferrule - R7 Hose |
| SN07-04 | 1/4 Swage Ferrule - R7 Hose |
| SN07-05 | 5/16 Swage Ferrule - R7 hose |
| SN07-06 | 3/8 Swage Ferrule - R7 Hose |
| SN07-08 | 1/2 Swage Ferrule - R7 Hose |
| SN07-10 | 5/8 Swage Ferrule - R7 Hose |
| SN07-12 | 3/4 Swage Ferrule - R7 Hose |
| SN07-16 | 1 Swage Ferrule - R7 Hose |

Ferrule for EFG4K & EFG6K Multi Spiral Hose

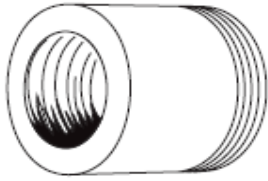

| | |
|---------|--------------------------------------|
| SNMS-06 | 3/8 Swage Ferrule – EFG*K Gates Hose |
| SNMS-08 | 1/2 Swage Ferrule – EFG*K Gates Hose |
| SNMS-10 | 5/8 Swage Ferrule – EFG*K Gates Hose |
| SNMS-12 | 3/4 Swage Ferrule – EFG*K Gates Hose |
| SNMS-16 | 1 Swage Ferrule – EFG*K Gates Hose |

Ferrule for EFG4K -20 Multi Spiral Hose

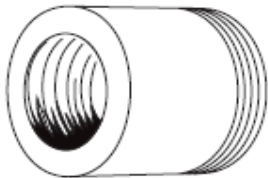

| | |
|---------|--|
| SN4K-20 | 1-1/4 Swage Ferrule – EFG4K Gates Hose |
|---------|--|

Ferrule for EFG6K -20 Multi Spiral Hose

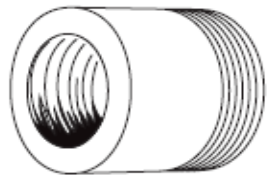

| | |
|---------|--|
| SN6K-20 | 1-1/4 Swage Ferrule – EFG6K Gates Hose |
|---------|--|

Two Piece Hosetails

BSP Banjo to R1/R2 Hose

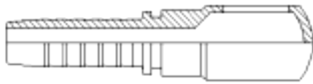

| | |
|--------------|--------------------------|
| STB-BBJ-0404 | 1/4 Tail x 1/4 BSP Banjo |
| STB-BBJ-0604 | 3/8 Tail x 1/4 BSP Banjo |
| STB-BBJ-0606 | 3/8 Tail x 3/8 BSP Banjo |
| STB-BBJ-0806 | 1/2 Tail x 3/8 BSP Banjo |
| STB-BBJ-0808 | 1/2 Tail x 1/2 BSP Banjo |
| STB-BBJ-1010 | 5/8 Tail x 5/8 BSP Banjo |
| STB-BBJ-1212 | 3/4 Tail x 3/4 BSP Banjo |
| STB-BBJ-1616 | 1 Tail x 1 BSP Banjo |

BSP Inverted Cone (JIS) Female to R1/R2 Hose

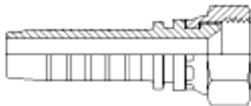

| | |
|--------------|-----------------------------------|
| STB-BJF-0404 | 1/4 Tail x 1/4 BSPSF-Inverted |
| STB-BJF-0406 | 1/4 Tail x 3/8 BSPFS-Inverted |
| STB-BJF-0606 | 3/8 Tail x 3/8 BSPFS-Inverted |
| STB-BJF-0608 | 3/8 Tail x 1/2 BSPFS-Inverted |
| STB-BJF-0808 | 1/2 Tail x 1/2 BSPFS-Inverted |
| STB-BJF-1212 | 3/4 Tail x 3/4 BSPFS-Inverted |
| STB-BJF-1616 | 1 Tail x 1 BSPFS-Inverted |
| STB-BJF-2020 | 1-1/4 Tail x 1-1/4 BSPFS-Inverted |
| STB-BJF-2424 | 1-1/2 Tail x 1-1/2 BSPFS-Inverted |

BSPP Male to R1/R2 Hose

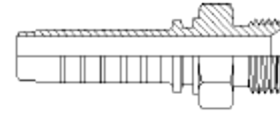

| | |
|--------------|--------------------------|
| STB-BPM-0404 | 1/4 Tail x 1/4 BSPPM |
| STB-BPM-0406 | 1/4 Tail x 3/8 BSPPM |
| STB-BPM-0506 | 5/16 Tail x 3/8 BSPPM |
| STB-BPM-0604 | 3/8 Tail x 1/4 BSPPM |
| STB-BPM-0606 | 3/8 Tail x 3/8 BSPPM |
| STB-BPM-0608 | 3/8 Tail x 1/2 BSPPM |
| STB-BPM-0806 | 1/2 Tail x 3/8 BSPPM |
| STB-BPM-0808 | 1/2 Tail x 1/2 BSPPM |
| STB-BPM-1010 | 5/8 Tail x 5/8 BSPPM |
| STB-BPM-1012 | 5/8 Tail x 3/4 BSPPM |
| STB-BPM-1212 | 3/4 Tail x 3/4 BSPPM |
| STB-BPM-1216 | 3/4 Tail x 1 BSPPM |
| STB-BPM-1612 | 1 Tail x 3/4 BSPPM |
| STB-BPM-1616 | 1 Tail x 1 BSPPM |
| STB-BPM-2020 | 1-1/4 Tail x 1-1/4 BSPPM |

BSPP Female Swivel to R1/R2 Hose

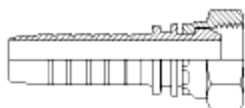

| | |
|--------------|--------------------------|
| STB-BSF-0302 | 3/16 Tail x 1/8 BSPFS |
| STB-BSF-0304 | 3/16 Tail x 1/4 BSPFS |
| STB-BSF-0402 | 1/4 Tail x 1/8 BSPFS |
| STB-BSF-0404 | 1/4 Tail x 1/4 BSPFS |
| STB-BSF-0406 | 1/4 Tail x 3/8 BSPFS |
| STB-BSF-0506 | 5/16 Tail x 3/8 BSPFS |
| STB-BSF-0604 | 3/8 Tail x 1/4 BSPFS |
| STB-BSF-0606 | 3/8 Tail x 3/8 BSPFS |
| STB-BSF-0608 | 3/8 Tail x 1/2 BSPFS |
| STB-BSF-0806 | 1/2 Tail x 3/8 BSPFS |
| STB-BSF-0808 | 1/2 Tail x 1/2 BSPFS |
| STB-BSF-0810 | 1/2 Tail x 5/8 BSPFS |
| STB-BSF-0812 | 1/2 Tail x 3/4 BSPFS |
| STB-BSF-1008 | 5/8 Tail x 1/2 BSPFS |
| STB-BSF-1010 | 5/8 Tail x 5/8 BSPFS |
| STB-BSF-1012 | 5/8 Tail x 3/4 BSPFS |
| STB-BSF-1212 | 3/4 Tail x 3/4 BSPFS |
| STB-BSF-1216 | 3/4 Tail x 1 BSPFS |
| STB-BSF-1616 | 1 Tail x 1 BSPFS |
| STB-BSF-1620 | 1 Tail x 1-1/4 BSPFS |
| STB-BSF-2020 | 1-1/4 Tail x 1-1/4 BSPFS |
| STB-BSF-2424 | 1-1/2 Tail x 1-1/2 BSPFS |
| STB-BSF-3232 | 2 Tail x 2 BSPFS |

BSPT Male to R1/R2 Hose

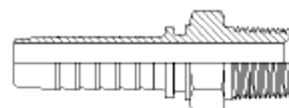

| | |
|--------------|--------------------------|
| STB-BTM-0402 | 1/4 Tail x 1/8 BSPTM |
| STB-BTM-0404 | 1/4 Tail x 1/4 BSPTM |
| STB-BTM-0406 | 1/4 Tail x 3/8 BSPTM |
| STB-BTM-0506 | 5/16 Tail x 3/8 BSPTM |
| STB-BTM-0604 | 3/8 Tail x 1/4 BSPTM |
| STB-BTM-0606 | 3/8 Tail x 3/8 BSPTM |
| STB-BTM-0608 | 3/8 Tail x 1/2 BSPTM |
| STB-BTM-0806 | 1/2 Tail x 3/8 BSPTM |
| STB-BTM-0808 | 1/2 Tail x 1/2 BSPTM |
| STB-BTM-0812 | 1/2 Tail x 3/4 BSPTM |
| STB-BTM-1008 | 5/8 Tail x 1/2 BSPTM |
| STB-BTM-1010 | 5/8 Tail x 5/8 BSPTM |
| STB-BTM-1012 | 5/8 Tail x 3/4 BSPTM |
| STB-BTM-1208 | 3/4 Tail x 1/2 BSPTM |
| STB-BTM-1212 | 3/4 Tail x 3/4 BSPTM |
| STB-BTM-1216 | 3/4 Tail x 1 BSPTM |
| STB-BTM-1612 | 1 Tail x 3/4 BSPTM |
| STB-BTM-1616 | 1 Tail x 1 BSPTM |
| STB-BTM-2020 | 1-1/4 Tail x 1-1/4 BSPTM |
| STB-BTM-2424 | 1-1/2 Tail x 1-1/2 BSPTM |
| STB-BTM-3232 | 2 Tail x 2 BSPTM |

SAE Code 61 Flange to R1/R2 Hose



| | |
|--------------|-----------------------------------|
| STB-F61-0808 | 1/2 Tail x 1/2 Code 61 Flange |
| STB-F61-0812 | 1/2 Tail x 3/4 Code 61 Flange |
| STB-F61-1012 | 5/8 Tail x 3/4 Code 61 Flange |
| STB-F61-1212 | 3/4 Tail x 3/4 Code 61 Flange |
| STB-F61-1216 | 3/4 Tail x 1 Code 61 Flange |
| STB-F61-1616 | 1 Tail x 1 Code 61 Flange |
| STB-F61-1620 | 1 Tail x 1-1/4 Code 61 Flange |
| STB-F61-2016 | 1-1/4 Tail x 1 Code 61 Flange |
| STB-F61-2020 | 1-1/4 Tail x 1-1/4 Code 61 Flange |
| STB-F61-2024 | 1-1/4 Tail x 1-1/2 Code 61 Flange |
| STB-F61-2424 | 1-1/2 Tail x 1-1/2 Code 61 Flange |
| STB-F61-2432 | 1-1/2 Tail x 2 Code 61 Flange |
| STB-F61-3232 | 2 Tail x 2 Code 61 Flange |

BSPT Male Live Swivel to R1/R2 Hose



| | |
|--------------|----------------------------------|
| STB-BSM-0404 | 1/4 Tail x 1/4 BSPTM Live Swivel |
| STB-BSM-0606 | 3/8 Tail x 3/8 BSPTM Live Swivel |
| STB-BSM-0808 | 1/2 Tail x 1/2 BSPTM Live Swivel |

JIC Female Swivel to R1/R2 Hose

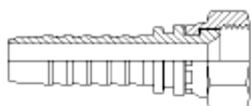

| | |
|--------------|--------------------------|
| STB-JIF-0307 | 3/16 Tail x 7/16 JICFS |
| STB-JIF-0407 | 1/4 Tail x 7/16 JICFS |
| STB-JIF-0408 | 1/4 Tail x 1/2 JICFS |
| STB-JIF-0409 | 1/4 Tail x 9/16 JICFS |
| STB-JIF-0412 | 1/4 Tail x 3/4 JICFS |
| STB-JIF-0509 | 5/16 Tail x 9/16 JICFS |
| STB-JIF-0608 | 3/8 Tail x 1/2 JICFS |
| STB-JIF-0609 | 3/8 Tail x 9/16 JICFS |
| STB-JIF-0612 | 3/8 Tail x 3/4 JICFS |
| STB-JIF-0614 | 3/8 Tail x 7/8 JICFS |
| STB-JIF-0809 | 1/2 Tail x 9/16 JICFS |
| STB-JIF-0812 | 1/2 Tail x 3/4 JICFS |
| STB-JIF-0814 | 1/2 Tail x 7/8 JICFS |
| STB-JIF-0817 | 1/2 Tail x 1-1/16 JICFS |
| STB-JIF-1014 | 5/8 Tail x 7/8 JICFS |
| STB-JIF-1017 | 5/8 Tail x 1-1/16 JICFS |
| STB-JIF-1214 | 3/4 Tail x 7/8 JICFS |
| STB-JIF-1217 | 3/4 Tail x 1-1/16 JICFS |
| STB-JIF-1219 | 3/4 Tail x 1-3/16 JICFS |
| STB-JIF-1221 | 3/4 Tail x 1-5/16 JICFS |
| STB-JIF-1617 | 1 Tail x 1-1/16 JICFS |
| STB-JIF-1619 | 1 Tail x 1-3/16 JICFS |
| STB-JIF-1621 | 1 Tail x 1-5/16 JICFS |
| STB-JIF-1626 | 1 Tail x 1-5/8 JICFS |
| STB-JIF-2026 | 1-1/4 Tail x 1-5/8 JICFS |
| STB-JIF-2430 | 1-1/2 Tail x 1-7/8 JICFS |
| STB-JIF-3240 | 2 Tail x 2-1/2 JICFS |

Metric Waterwash to R1/R2 Hose

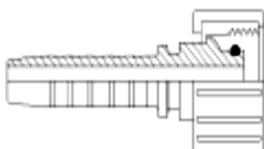

| | |
|--------------|--------------------------------|
| STB-KAR-0422 | 1/4 Tail x M22 Karcher Female |
| STB-KAR-0522 | 5/16 Tail x M22 Karcher Female |
| STB-KAR-0622 | 3/8 Tail x M22 Karcher Female |

JIC Male to R1/R2 Hose



| | |
|--------------|-------------------------|
| STB-JIM-0407 | 1/4 Tail x 7/16 JICM |
| STB-JIM-0408 | 1/4 Tail x 1/2 JICM |
| STB-JIM-0409 | 1/4 Tail x 9/16 JICM |
| STB-JIM-0509 | 5/16 Tail x 9/16 JICM |
| STB-JIM-0609 | 3/8 Tail x 9/16 JICM |
| STB-JIM-0612 | 3/8 Tail x 3/4 JICM |
| STB-JIM-0614 | 3/8 Tail x 7/8 JICM |
| STB-JIM-0812 | 1/2 Tail x 3/4 JICM |
| STB-JIM-0814 | 1/2 Tail x 7/8 JICM |
| STB-JIM-0817 | 1/2 Tail x 1-1/16 JICM |
| STB-JIM-1014 | 5/8 Tail x 7/8 JICM |
| STB-JIM-1017 | 5/8 Tail x 1-1/16 JICM |
| STB-JIM-1214 | 3/4 Tail x 7/8 JICM |
| STB-JIM-1217 | 3/4 Tail x 1-1/16 JICM |
| STB-JIM-1219 | 3/4 Tail x 1-3/16 JICM |
| STB-JIM-1221 | 3/4 Tail x 1-5/16 JICM |
| STB-JIM-1617 | 1 Tail x 1-1/16 JICM |
| STB-JIM-1621 | 1 Tail x 1-5/16 JICM |
| STB-JIM-1626 | 1 Tail x 1-5/8 JICM |
| STB-JIM-2026 | 1-1/4 Tail x 1-5/8 JICM |
| STB-JIM-2430 | 1-1/2 Tail x 1-7/8 JICM |

Metric Banjo to R1/R2 Hose

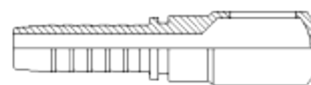

| | |
|--------------|------------------------|
| STB-MBJ-0410 | 1/4 Tail x 10mm Banjo |
| STB-MBJ-0412 | 1/4 Tail x 12mm Banjo |
| STB-MBJ-0414 | 1/4 Tail x 14mm Banjo |
| STB-MBJ-0416 | 1/4 Tail 16mm Banjo |
| STB-MBJ-0514 | 5/16 Tail x 14mm Banjo |
| STB-MBJ-0612 | 3/8 Tail x 12mm Banjo |
| STB-MBJ-0614 | 3/8 Tail x 14mm Banjo |
| STB-MBJ-0616 | 3/8 Tail x 16mm Banjo |
| STB-MBJ-0618 | 3/8 Tail x 18mm Banjo |
| STB-MBJ-0620 | 3/8 Tail x 20mm Banjo |
| STB-MBJ-0818 | 1/2 Tail x 18mm Banjo |
| STB-MBJ-0822 | 1/2 Tail x 22mm Banjo |
| STB-MBJ-1022 | 5/8 Tail x 22mm Banjo |
| STB-MBJ-1226 | 3/4 Tail x 26mm Banjo |
| STB-MBJ-1630 | 1 Tail x 30mm Banjo |

Metric Chinese (Female Flat Seat) to R1/R2 Hose



| | |
|--------------|-------------------------------|
| STB-MCF-0414 | 1/4 Tail x M14 Chinese Metric |
| STB-MCF-0416 | 1/4 Tail x M16 Chinese Metric |
| STB-MCF-0616 | 3/8 Tail x M16 Chinese Metric |
| STB-MCF-0618 | 3/8 Tail x M18 Chinese Metric |
| STB-MCF-0620 | 3/8 Tail x M20 Chinese Metric |
| STB-MCF-0822 | 1/2 Tail x M22 Chinese Metric |
| STB-MCF-0824 | 1/2 Tail x M24 Chinese Metric |
| STB-MCF-1027 | 5/8 Tail x M27 Chinese Metric |
| STB-MCF-1230 | 3/4 Tail x M30 Chinese Metric |
| STB-MCF-1236 | 3/4 Tail x M36 Chinese Metric |
| STB-MCF-1636 | 1 Tail x M36 Chinese Metric |

Metric Heavy Female to R1/R2 Hose



| | |
|--------------|-------------------------------|
| STB-MHF-0414 | 1/4 Tail x M14 Heavy Female |
| STB-MHF-0416 | 1/4 Tail x M16 Heavy Female |
| STB-MHF-0418 | 1/4 Tail x M18 Heavy Female |
| STB-MHF-0420 | 1/4 Tail x M20 Heavy Female |
| STB-MHF-0520 | 5/16 Tail x M20 Heavy Female |
| STB-MHF-0618 | 3/8 Tail x M18 Heavy Female |
| STB-MHF-0620 | 3/8 Tail x M20 Heavy Female |
| STB-MHF-0622 | 3/8 Tail x M22 Heavy Female |
| STB-MHF-0624 | 3/8 Tail x M24 Heavy Female |
| STB-MHF-0820 | 1/2 Tail x M20 Heavy Female |
| STB-MHF-0822 | 1/2 Tail x M22 Heavy Female |
| STB-MHF-0824 | 1/2 Tail x M24 Heavy Female |
| STB-MHF-1024 | 5/8 Tail x M24 Heavy Female |
| STB-MHF-1030 | 5/8 Tail x M30 Heavy Female |
| STB-MHF-1230 | 3/4 Tail x M30 Heavy Female |
| STB-MHF-1236 | 3/4 Tail x M36 Heavy Female |
| STB-MHF-1636 | 1 Tail x M36 Heavy Female |
| STB-MHF-1642 | 1 Tail x M42 Heavy Female |
| STB-MHF-2052 | 1-1/4 Tail x M52 Heavy Female |
| STB-MHF-2452 | 1-1/2 Tail x M52 Heavy Female |

Metric Heavy Male to R1/R2 Hose

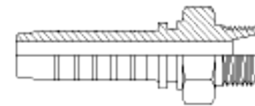

| | |
|--------------|-----------------------------|
| STB-MHM-0414 | 1/4 Tail x M14 Heavy Male |
| STB-MHM-0416 | 1/4 Tail x M16 Heavy Male |
| STB-MHM-0418 | 1/4 Tail x M18 Heavy Male |
| STB-MHM-0420 | 1/4 Tail x M20 Heavy Male |
| STB-MHM-0520 | 5/16 Tail x M20 Heavy Male |
| STB-MHM-0618 | 3/8 Tail x M18 Heavy Male |
| STB-MHM-0620 | 3/8 Tail x M20 Heavy Male |
| STB-MHM-0622 | 3/8 Tail x M22 Heavy Male |
| STB-MHM-0822 | 1/2 Tail x M22 Heavy Male |
| STB-MHM-0824 | 1/2 Tail x M24 Heavy Male |
| STB-MHM-1030 | 5/8 Tail x M30 Heavy Male |
| STB-MHM-1230 | 3/4 Tail x M30 Heavy Male |
| STB-MHM-1236 | 3/4 Tail x M36 Heavy Male |
| STB-MHM-1636 | 1 Tail x M36 Heavy Male |
| STB-MHM-1642 | 1 Tail x M42 Heavy Male |
| STB-MHM-2052 | 1-1/4 Tail x M52 Heavy Male |

Metric JIS Female (Komatsu) to R1/R2 Hose

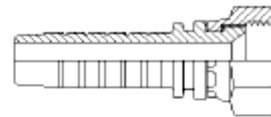

| | |
|--------------|---------------------------------|
| STB-MKF-0414 | 1/4 Tail x M14 Komatsu Female |
| STB-MKF-0418 | 1/4 Tail x M18 Komatsu Female |
| STB-MKF-0614 | 3/8 Tail x M14 Komatsu Female |
| STB-MKF-0616 | 3/8 Tail x M16 Komatsu Female |
| STB-MKF-0618 | 3/8 Tail x M18 Komatsu Female |
| STB-MKF-0818 | 1/2 Tail x M18 Komatsu Female |
| STB-MKF-0820 | 1/2 Tail x M20 Komatsu Female |
| STB-MKF-0822 | 1/2 Tail x M22 Komatsu Female |
| STB-MKF-0824 | 1/2 Tail x M24 Komatsu Female |
| STB-MKF-1024 | 5/8 Tail x M24 Komatsu Female |
| STB-MKF-1026 | 5/8 Tail x M26 Komatsu Female |
| STB-MKF-1224 | 3/4 Tail x M24 Komatsu Female |
| STB-MKF-1230 | 3/4 Tail x M30 Komatsu Female |
| STB-MKF-1233 | 3/4 Tail x M33 Komatsu Female |
| STB-MKF-1633 | 1 Tail x M33 Komatsu Female |
| STB-MKF-1636 | 1 Tail x M36 Komatsu Female |
| STB-MKF-2036 | 1-1/4 Tail x M36 Komatsu Female |
| STB-MKF-2042 | 1-1/4 Tail x M42 Komatsu Female |
| STB-MKF-2442 | 1-1/2 Tail x M42 Komatsu Female |

Metric JIS Male (Komatsu) to R1/R2 Hose

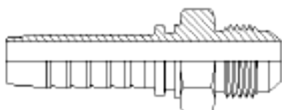

| | |
|--------------|-----------------------------|
| STB-MKM-0414 | 1/4 Tail x M14 Komatsu Male |
| STB-MKM-0616 | 3/8 Tail x M16 Komatsu Male |
| STB-MKM-0618 | 3/8 Tail x M18 Komatsu Male |
| STB-MKM-0822 | 1/2 Tail x M22 Komatsu Male |
| STB-MKM-0824 | 1/2 Tail x M24 Komatsu Male |
| STB-MKM-1230 | 3/4 Tail x M30 Komatsu Male |

Metric Light Female to R1/R2 Hose



| | |
|--------------|-------------------------------|
| STB-MLF-0412 | 1/4 Tail x M12 Light Female |
| STB-MLF-0414 | 1/4 Tail x M14 Light Female |
| STB-MLF-0416 | 1/4 Tail x M16 Light Female |
| STB-MLF-0418 | 1/4 Tail x M18 Light Female |
| STB-MLF-0516 | 5/16 Tail x M16 Light Female |
| STB-MLF-0616 | 3/8 Tail x M16 Light Female |
| STB-MLF-0618 | 3/8 Tail x M18 Light Female |
| STB-MLF-0622 | 3/8 Tail x M22 Light Female |
| STB-MLF-0818 | 1/2 Tail x M22 Light Female |
| STB-MLF-0822 | 1/2 Tail x M22 Light Female |
| STB-MLF-0826 | 1/2 Tail x M26 Light Female |
| STB-MLF-1026 | 5/8 Tail x M26 Light Female |
| STB-MLF-1030 | 5/8 Tail x M30 Light Female |
| STB-MLF-1226 | 3/4 Tail x M26 Light Female |
| STB-MLF-1230 | 3/4 Tail x M30 Light Female |
| STB-MLF-1636 | 1 Tail x M36 Light Female |
| STB-MLF-2045 | 1-1/4 Tail x M45 Light Female |
| STB-MLF-2452 | 1-1/2 Tail x M52 Light Female |

Metric Light Male to R1/R2 Hose

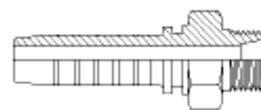

| | |
|--------------|-----------------------------|
| STB-MLM-0412 | 1/4 Tail x M12 Light Male |
| STB-MLM-0414 | 1/4 Tail x M14 Light Male |
| STB-MLM-0416 | 1/4 Tail x M16 Light Male |
| STB-MLM-0418 | 1/4 Tail x M18 Light Male |
| STB-MLM-0616 | 3/8 Tail x M16 Light Male |
| STB-MLM-0618 | 3/8 Tail x M18 Light Male |
| STB-MLM-0622 | 3/8 Tail x M22 Light Male |
| STB-MLM-0822 | 1/2 Tail x M22 Light Male |
| STB-MLM-0826 | 1/2 Tail x M26 Light Male |
| STB-MLM-1026 | 5/8 Tail x M26 Light Male |
| STB-MLM-1030 | 5/8 Tail x M30 Light Male |
| STB-MLM-1226 | 3/4 Tail x M26 Light Male |
| STB-MLM-1230 | 3/4 Tail x M30 Light male |
| STB-MLM-1236 | 3/4 Tail x M36 Light Male |
| STB-MLM-1636 | 1 Tail x M36 Light Male |
| STB-MLM-2045 | 1-1/4 Tail x M45 Light male |
| STB-MLM-2452 | 1-1/2 Tail x M52 Light male |

Metric Standpipe to R1/R2 Hose



| | |
|--------------|---------------------------|
| STB-MSP-0406 | 1/4 Tail x 6mm Standpipe |
| STB-MSP-0408 | 1/4 Tail x 8mm Standpipe |
| STB-MSP-0410 | 1/4 Tail x 10mm Standpipe |
| STB-MSP-0412 | 1/4 Tail x 12mm Standpipe |
| STB-MSP-0508 | 5/16 Tail x 8mm Standpipe |
| STB-MSP-0610 | 3/8 Tail x 10mm Standpipe |
| STB-MSP-0612 | 3/8 Tail x 12mm Standpipe |
| STB-MSP-0614 | 3/8 Tail x 14mm Standpipe |
| STB-MSP-0615 | 3/8 Tail x 15mm Standpipe |
| STB-MSP-0814 | 1/2 Tail x 14mm Standpipe |
| STB-MSP-0815 | 1/2 Tail x 15mm Standpipe |
| STB-MSP-0816 | 1/2 Tail x 16mm Standpipe |
| STB-MSP-0818 | 1/2 Tail x 18mm Standpipe |
| STB-MSP-0820 | 1/2 Tail x 20mm Standpipe |
| STB-MSP-0822 | 1/2 Tail x 22mm Standpipe |

Metric Multi Seal Female Swivel to R1/R2 Hose

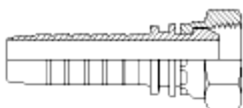

| | |
|--------------|-----------------------------------|
| STB-MMS-0414 | 1/4 Tail x 14mm Metric Multi Seal |
| STB-MMS-0416 | 1/4 Tail x 16mm Metric Multi Seal |
| STB-MMS-0616 | 3/8 Tail x 16mm Metric Multi Seal |
| STB-MMS-0618 | 3/8 Tail x 18mm Metric Multi Seal |
| STB-MMS-0822 | 1/2 Tail x 22mm Metric Multi Seal |
| STB-MMS-0826 | 1/2 Tail x 26mm Metric Multi Seal |
| STB-MMS-1026 | 5/8 Tail x 26mm Metric Multi Seal |

NPT Female Swivel to R1/R2 Hose



| | |
|--------------|---------------------------|
| STB-NSF-0404 | 1/4 Tail x 1/4 NPT Female |
| STB-NSF-0606 | 3/8 Tail x 3/8 NPT Female |

NPT Male to R1/R2 Hose



| | |
|--------------|-------------------------|
| STB-NTM-0402 | 1/4 Tail x 1/8 NPTM |
| STB-NTM-0404 | 1/4 Tail x 1/4 NPTM |
| STB-NTM-0406 | 1/4 Tail x 3/8 NPTM |
| STB-NTM-0604 | 3/8 Tail x 1/4 NPTM |
| STB-NTM-0606 | 3/8 Tail x 3/8 NPTM |
| STB-NTM-0608 | 3/8 Tail x 1/2 NPTM |
| STB-NTM-0806 | 1/2 Tail x 3/8 NPTM |
| STB-NTM-0808 | 1/2 Tail x 1/2 NPTM |
| STB-NTM-1008 | 5/8 Tail x 1/2 NPTM |
| STB-NTM-1012 | 5/8 Tail x 3/4 NPTM |
| STB-NTM-1212 | 3/4 Tail x 3/4 NPTM |
| STB-NTM-1216 | 3/4 Tail x 1 NPTM |
| STB-NTM-1612 | 1 Tail x 3/4 NPTM |
| STB-NTM-1616 | 1 Tail x 1 NPTM |
| STB-NTM-2016 | 1-1/4 Tail x 1 NPTM |
| STB-NTM-2020 | 1-1/4 Tail x 1-1/4 NPTM |
| STB-NTM-2424 | 1-1/2 Tail x 1-1/2 NPTM |
| STB-NTM-3232 | 2 Tail x 2 NPTM |

ORFS Female Swivel to R1/R2 Hose



| | |
|--------------|----------------------------------|
| STB-ORF-0409 | 1/4 Tail x 9/16 ORFS Female |
| STB-ORF-0411 | 1/4 Tail x 11/16 ORFS Female |
| STB-ORF-0609 | 3/8 Tail x 9/16 ORFS Female |
| STB-ORF-0611 | 3/8 Tail x 11/16 ORFS Female |
| STB-ORF-0613 | 3/8 Tail x 13/16 ORFS Female |
| STB-ORF-0811 | 1/2 Tail x 11/16 ORFS Female |
| STB-ORF-0813 | 1/2 Tail x 13/16 ORFS Female |
| STB-ORF-0816 | 1/2 Tail x 1 ORFS Female |
| STB-ORF-0819 | 1/2 Tail x 1-3/16 ORFS Female |
| STB-ORF-1016 | 5/8 Tail x 1 ORFS Female |
| STB-ORF-1019 | 5/8 Tail x 1-3/16 ORFS Female |
| STB-ORF-1216 | 3/4 Tail x 1 ORFS Female |
| STB-ORF-1219 | 3/4 Tail x 1-3/16 ORFS Female |
| STB-ORF-1223 | 3/4 Tail x 1-7/16 ORFS Female |
| STB-ORF-1623 | 1 Tail x 1-7/16 ORFS Female |
| STB-ORF-2027 | 1-1/4 Tail x 1-11/16 ORFS Female |
| STB-ORF-2432 | 1-1/2 Tail x 2 ORFS Female |

ORFS Male to R1/R2 Hose

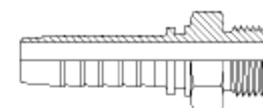

| | |
|--------------|-----------------------------|
| STB-ORM-0409 | 1/4 Tail x 9/16 ORFS Male |
| STB-ORM-0611 | 3/8 Tail x 11/16 ORFS Male |
| STB-ORM-0613 | 3/8 Tail x 13/16 ORFS Male |
| STB-ORM-0813 | 1/2 Tail x 13/16 ORFS Male |
| STB-ORM-1016 | 5/8 Tail x 1 ORFS Male |
| STB-ORM-1019 | 5/8 Tail x 1-3/16 ORFS Male |
| STB-ORM-1219 | 3/4 Tail x 1-3/16 ORFS Male |

SAE Female Swivel (45 Degree Cone) to R1/R2 Hose

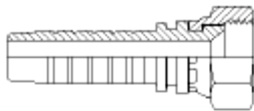

| | |
|--------------|------------------------------|
| STB-SAF-0407 | 1/4 Tail x 7/16 SAE Female |
| STB-SAF-0610 | 3/8 Tail x 5/8 SAE Female |
| STB-SAF-0812 | 1/2 Tail x 3/4 SAE Female |
| STB-SAF-1017 | 5/8 Tail x 1-1/16 SAE Female |
| STB-SAF-1217 | 3/4 Tail x 1-1/16 SAE Female |

Double Connector (Hose Joiner) to R1/R2 Hose

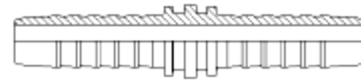

| | |
|--------------|------------------------|
| STB-STB-0303 | 3/16 Swage Tail Joiner |
| STB-STB-0404 | 1/4 Swage Tail Joiner |
| STB-STB-0505 | 5/16 Swage Tail Joiner |
| STB-STB-0606 | 3/8 Swage Tail Joiner |
| STB-STB-0808 | 1/2 Swage Tail Joiner |
| STB-STB-1010 | 5/8 Swage Tail Joiner |
| STB-STB-1212 | 3/4 Swage Tail Joiner |

SAE Male (45 Degree Cone) to R1/R2 Hose

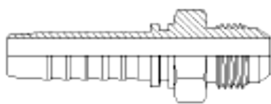

| | |
|--------------|----------------------------|
| STB-SAM-0407 | 1/4 Tail x 7/16 SAE Male |
| STB-SAM-0610 | 3/8 Tail x 5/8 SAE Male |
| STB-SAM-0812 | 1/2 Tail x 3/4 SAE Male |
| STB-SAM-1217 | 3/4 Tail x 1-1/16 SAE Male |

Weld On to R1/R2 Hose

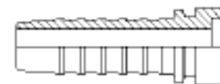

| | |
|--------------|--------------------------------|
| STB-TWF-0404 | 1/4 Tail x 1/4 OD Tubeweld |
| STB-TWF-0504 | 5/16 Tail x 1/4 OD Tubeweld |
| STB-TWF-0604 | 3/8 Tail x 1/4 OD Tubeweld |
| STB-TWF-0606 | 3/8 Tail x 3/8 OD Tubeweld |
| STB-TWF-0608 | 3/8 Tail x 1/2 OD Tubeweld |
| STB-TWF-0808 | 1/2 Tail x 1/2 OD Tubeweld |
| STB-TWF-0810 | 1/2 Tail x 5/8 OD Tubeweld |
| STB-TWF-1010 | 5/8 Tail x 5/8 OD Tubeweld |
| STB-TWF-1210 | 3/4 Tail x 5/8 OD Tubeweld |
| STB-TWF-1212 | 3/4 Tail x 3/4 OD Tubeweld |
| STB-TWF-1616 | 1 Tail x 1 OD Tubeweld |
| STB-TWF-2020 | 1-1/4 Tail x 1-1/4 OD Tubeweld |

WEO Male to R1/R2 Hose

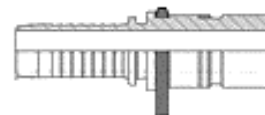

| | |
|--------------|----------------------------|
| STB-WEO-0404 | 1/4 Tail x 1/4 WEO Plug-In |
| STB-WEO-0406 | 1/4 Tail x 3/8 WEO Plug-In |
| STB-WEO-0606 | 3/8 Tail x 3/8 WEO Plug-In |
| STB-WEO-0608 | 3/8 Tail x 1/2 WEO Plug-In |
| STB-WEO-0808 | 1/2 Tail x 1/2 WEO Plug-In |
| STB-WEO-1212 | 3/4 Tail x 3/4 WEO Plug-In |
| STB-WEO-1616 | 1 Tail x 1 WEO Plug-In |

Two Piece Hosetail 45°

BSPF Female Swivel 45 Swept to R1/R2 Hose

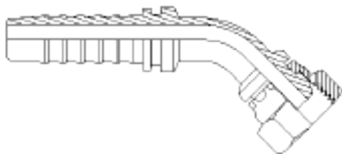

| | |
|------------------|------------------------------|
| STB-BSF-45S-0404 | 1/4 Tail x 1/4 BSPFS 45° |
| STB-BSF-45S-0406 | 1/4 Tail x 3/8 BSPFS 45° |
| STB-BSF-45S-0506 | 5/16 Tail x 3/8 BSPFS 45° |
| STB-BSF-45S-0606 | 3/8 Tail x 3/8 BSPFS 45° |
| STB-BSF-45S-0608 | 3/8 Tail x 1/2 BSPFS 45° |
| STB-BSF-45S-0808 | 1/2 Tail x 1/2 BSPFS 45° |
| STB-BSF-45S-1010 | 5/8 Tail x 5/8 BSPFS 45° |
| STB-BSF-45S-1212 | 3/4 Tail x 3/4 BSPFS 45° |
| STB-BSF-45S-1616 | 1 Tail x 1 BSPFS 45° |
| STB-BSF-45S-2020 | 1-1/4 Tail x 1-1/4 BSPFS 45° |
| STB-BSF-45S-2424 | 1-1/2 Tail x 1-1/2 BSPFS 45° |
| STB-BSF-45S-3232 | 2 Tail x 2 BSPFS 45° |

SAE Code 61 Flange 45 Degree Swept to R1/R2 Hose

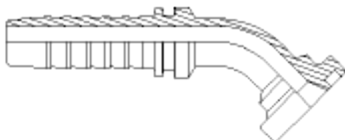

| | |
|------------------|---------------------------------------|
| STB-F61-45S-0808 | 1/2 Tail x 1/2 Code 61 Flange 45° |
| STB-F61-45S-0812 | 1/2 Tail x 3/4 Code 61 Flange 45° |
| STB-F61-45S-1010 | 5/8 Tail x 5/8 Code 61 Flange 45° |
| STB-F61-45S-1212 | 3/4 Tail x 3/4 Code 61 Flange 45° |
| STB-F61-45S-1216 | 3/4 Tail x 1 Code 61 Flange 45° |
| STB-F61-45S-1616 | 1 Tail x 1 Code 61 Flange 45° |
| STB-F61-45S-1620 | 1 Tail x 1-1/4 Code 61 Flange 45° |
| STB-F61-45S-2020 | 1-1/4 Tail x 1-1/4 Code 61 Flange 45° |
| STB-F61-45S-2024 | 1-1/4 Tail x 1-1/2 Code 61 Flange 45° |
| STB-F61-45S-2424 | 1-1/2 Tail x 1-1/2 Code 61 Flange 45° |
| STB-F61-45S-3232 | 2 Tail x 2 Code 61 Flange 45° |

JIC Female Swivel 45 Degree Swept to R1/R2 Hose

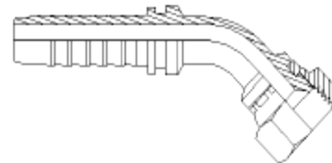

| | |
|------------------|------------------------------|
| STB-JIF-45S-0407 | 1/4 Tail x 7/16 JICFS 45° |
| STB-JIF-45S-0408 | 1/4 Tail x 1/2 JICFS 45° |
| STB-JIF-45S-0409 | 1/4 Tail x 9/16 JICFS 45° |
| STB-JIF-45S-0509 | 5/16 Tail x 9/16 JICFS 45° |
| STB-JIF-45S-0608 | 3/8 Tail x 1/2 JICFS 45° |
| STB-JIF-45S-0609 | 3/8 Tail x 9/16 JICFS 45° |
| STB-JIF-45S-0612 | 3/8 Tail x 3/4 JICFS 45° |
| STB-JIF-45S-0812 | 1/2 Tail x 3/4 JICFS 45° |
| STB-JIF-45S-0814 | 1/2 Tail x 7/8 JICFS 45° |
| STB-JIF-45S-0817 | 1/2 Tail x 1-1/16 JICFS 45° |
| STB-JIF-45S-1014 | 5/8 Tail x 7/8 JICFS 45° |
| STB-JIF-45S-1017 | 5/8 Tail x 1-1/16 JICFS 45° |
| STB-JIF-45S-1217 | 3/4 Tail x 1-1/16 JICFS 45° |
| STB-JIF-45S-1219 | 3/4 Tail x 1-3/16 JICFS 45° |
| STB-JIF-45S-1221 | 3/4 Tail x 1-5/16 JICFS 45° |
| STB-JIF-45S-1621 | 1 Tail x 1-5/16 JICFS 45° |
| STB-JIF-45S-2026 | 1-1/4 Tail x 1-5/8 JICFS 45° |
| STB-JIF-45S-2430 | 1-1/2 Tail x 1-7/8 JICFS 45° |
| STB-JIF-45S-3240 | 2 Tail X 2-1/2 JICFS 45° |

ORFS Female Swivel 45 Degree Swept to R1/R2 Hose

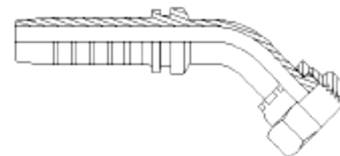

| | |
|------------------|-------------------------------|
| STB-ORF-45S-0409 | 1/4 Tail x 9/16 ORFS 45° |
| STB-ORF-45S-0411 | 1/4 Tail x 11/16 ORFS 45° |
| STB-ORF-45S-0611 | 3/8 Tail x 11/16 ORFS 45° |
| STB-ORF-45S-0613 | 3/8 Tail x 13/16 ORFS 45° |
| STB-ORF-45S-0813 | 1/2 Tail x 13/16 ORFS 45° |
| STB-ORF-45S-1016 | 5/8 Tail x 1ORFS 45° |
| STB-ORF-45S-1219 | 3/4 Tail x 1-3/16 ORFS 45° |
| STB-ORF-45S-1623 | 1 Tail x 1-7/16 ORFS 45° |
| STB-ORF-45S-2027 | 1-1/4 Tail x 1-11/16 ORFS 45° |

Metric Heavy Female 45 Degree Swept to R1/R2 Hose

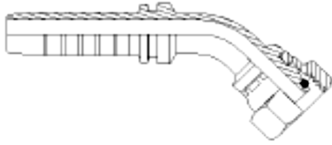

| | |
|------------------|----------------------------|
| STB-MHF-45S-0414 | 1/4 Tail x M14 Heavy 45° |
| STB-MHF-45S-0416 | 1/4 Tail x M16 Heavy 45° |
| STB-MHF-45S-0418 | 1/4 Tail x M18 Heavy 45° |
| STB-MHF-45S-0618 | 3/8 Tail x M18 Heavy 45° |
| STB-MHF-45S-0620 | 3/8 Tail x M20 Heavy 45° |
| STB-MHF-45S-0622 | 3/8 Tail x M22 Heavy 45° |
| STB-MHF-45S-0822 | 1/2 Tail x M22 Heavy 45° |
| STB-MHF-45S-0824 | 1/2 Tail x M24 Heavy 45° |
| STB-MHF-45S-1030 | 5/8 Tail x M30 Heavy 45° |
| STB-MHF-45S-1230 | 3/4 Tail x M30 Heavy 45° |
| STB-MHF-45S-1236 | 3/4 Tail x M36 Heavy 45° |
| STB-MHF-45S-1636 | 1 Tail x M36 Heavy 45° |
| STB-MHF-45S-1642 | 1 Tail x M42 Heavy 45° |
| STB-MHF-45S-2052 | 1-1/4 Tail x M52 Heavy 45° |

Metric Light Female 45 Degree Swept to R1/R2 Hose

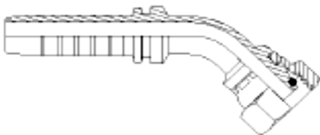

| | |
|------------------|----------------------------|
| STB-MLF-45S-0412 | 1/4 Tail x M12 Light 45° |
| STB-MLF-45S-0414 | 1/4 Tail x M14 Light 45° |
| STB-MLF-45S-0416 | 1/4 Tail x M16 Light 45° |
| STB-MLF-45S-0418 | 1/4 Tail x M18 Light 45° |
| STB-MLF-45S-0614 | 3/4 Tail x M14 Light 45° |
| STB-MLF-45S-0616 | 3/8 Tail x M16 Light 45° |
| STB-MLF-45S-0618 | 3/8 Tail x M18 Light 45° |
| STB-MLF-45S-0622 | 3/8 Tail x M22 Light 45° |
| STB-MLF-45S-0822 | 1/2 Tail x M22 Light 45° |
| STB-MLF-45S-0826 | 1/2 Tail x M26 Light 45° |
| STB-MLF-45S-1026 | 5/8 Tail x M26 Light 45° |
| STB-MLF-45S-1226 | 3/4 Tail x M26 Light 45° |
| STB-MLF-45S-1230 | 3/4 Tail x M30 Light 45° |
| STB-MLF-45S-1636 | 1 Tail x M36 Light 45° |
| STB-MLF-45S-2045 | 1-1/4 Tail x M45 Light 45° |

Two Piece Hosetail 90°

Compact

BSPF Female Swivel 90 Degree Compact to R1/R2 Hose

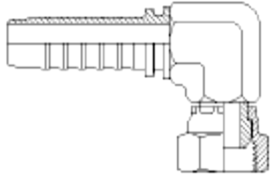

| | |
|------------------|-------------------------------|
| STB-BSF-90C-0404 | 1/4 Tail x 1/4 BSPFS 90° Comp |
| STB-BSF-90C-0406 | 1/4 Tail x 3/8 BSPFS 90° Comp |
| STB-BSF-90C-0606 | 3/8 Tail x 3/8 BSPFS 90° Comp |
| STB-BSF-90C-0608 | 3/8 Tail x 1/2 BSPFS 90° Comp |
| STB-BSF-90C-0808 | 1/2 Tail x 1/2 BSPFS 90° Comp |
| STB-BSF-90C-1010 | 5/8 Tail x 5/8 BSPFS 90° Comp |
| STB-BSF-90C-1212 | 3/4 Tail x 3/4 BSPFS 90° Comp |
| STB-BSF-90C-1616 | 1 Tail x 1 BSPFS 90° Comp |

UNO Male Live Swivel 90 Degree Compact to R1/R2 Hose

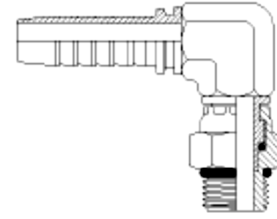

| | |
|------------------|--|
| STB-USM-90C-0812 | 1/2" Tail x 3/4" UNO 90° Comp Live Swivel |
| STB-USM-90C-0814 | 1/2" Tail x 7/8" UNO 90° Comp Live Swivel |

JIC Female Swivel 90 Degree Compact to R1/R2 Hose

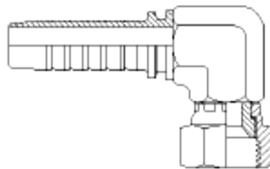

| | |
|------------------|----------------------------------|
| STB-JIF-90C-0407 | 1/4 Tail x 7/16 JICFS 90° Comp |
| STB-JIF-90C-0409 | 1/4 Tail x 9/16 JICFS 90° Comp |
| STB-JIF-90C-0609 | 3/8 Tail x 9/16 JICFS 90° Comp |
| STB-JIF-90C-0612 | 3/8 Tail x 3/4 JICFS 90° Comp |
| STB-JIF-90C-0812 | 1/2 Tail x 3/4 JICFS 90° Comp |
| STB-JIF-90C-0814 | 1/2 Tail x 7/8 JICFS 90° Comp |
| STB-JIF-90C-1217 | 3/4 Tail x 1-1/16 JICFS 90° Comp |
| STB-JIF-90C-1621 | 1 Tail x 1-5/16 JICFS 90° Comp |

Two Piece Hosetail 90°

BSP Inverted Cone (JIS) Female 90 Swept to R1/R2 Hose

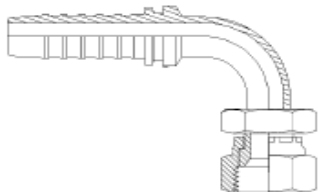

| | |
|------------------|-------------------------------|
| STB-BJF-90S-0404 | 1/4 Tail x 1/4 BSPFS-Inv. 90° |
| STB-BJF-90S-0406 | 1/4 Tail x 3/8 BSPFS-Inv. 90° |
| STB-BJF-90S-0606 | 3/8 Tail x 3/8 BSPFS-Inv. 90° |
| STB-BJF-90S-0808 | 1/2 Tail x 1/2 BSPFS-Inv. 90° |
| STB-BJF-90S-1212 | 3/4 Tail x 3/4 BSPFS-Inv. 90° |
| STB-BJF-90S-1616 | 1 Tail x 1 BSPFS-Inv. 90° |

SAE Code 61 Flange 90 Degree Swept to R1/R2

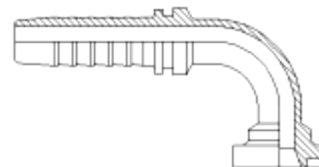

| | |
|------------------|------------------------------------|
| STB-F61-90S-0808 | 1/2 Tail x 1/2 Code 61 Fl. 90° |
| STB-F61-90S-0812 | 1/2 Tail x 3/4 Code 61 Fl. 90° |
| STB-F61-90S-1010 | 5/8 Tail x 5/8 Code 61 Fl. 90° |
| STB-F61-90S-1212 | 3/4 Tail x 3/4 Code 61 Fl. 90° |
| STB-F61-90S-1216 | 3/4 Tail x 1 Code 61 Fl. 90° |
| STB-F61-90S-1616 | 1 Tail x 1 Code 61 Fl. 90° |
| STB-F61-90S-1620 | 1 Tail x 1-1/4 Code 61 Fl. 90° |
| STB-F61-90S-2020 | 1-1/4 Tail x 1-1/4 Code 61 Fl. 90° |
| STB-F61-90S-2024 | 1-1/4 Tail x 1-1/2 Code 61 Fl. 90° |
| STB-F61-90S-2424 | 1-1/2 Tail x 1-1/2 Code 61 Fl. 90° |
| STB-F61-90S-2424 | 1-1/2 Tail x 2 Code 61 Fl. 90° |
| STB-F61-90S-3232 | 2 Tail x 2 Code 61 Fl. 90° |

BSP Female Swivel 90 Swept to R1/R2 Hose

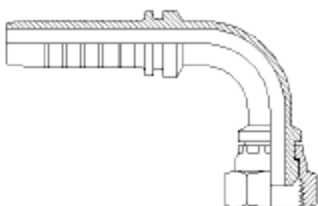

| | |
|------------------|------------------------------|
| STB-BSF-90S-0402 | 1/4 Tail x 1/8 BSPFS 90° |
| STB-BSF-90S-0404 | 1/4 Tail x 1/4 BSPFS 90° |
| STB-BSF-90S-0406 | 1/4 Tail x 3/8 BSPFS 90° |
| STB-BSF-90S-0604 | 3/8 Tail x 1/4 BSPFS 90° |
| STB-BSF-90S-0606 | 3/8 Tail x 3/8 BSPFS 90° |
| STB-BSF-90S-0608 | 3/8 Tail x 1/2 BSPFS 90° |
| STB-BSF-90S-0808 | 1/2 Tail x 1/2 BSPFS 90° |
| STB-BSF-90S-0810 | 1/2 Tail x 5/8 BSPFS 90° |
| STB-BSF-90S-0812 | 1/2 Tail x 3/4 BSPFS 90° |
| STB-BSF-90S-1010 | 5/8 Tail x 5/8 BSPFS 90° |
| STB-BSF-90S-1212 | 3/4 Tail x 3/4 BSPFS 90° |
| STB-BSF-90S-1216 | 3/4 Tail x 1 BSPFS 90° |
| STB-BSF-90S-1616 | 1 Tail x 1 BSPFS 90° |
| STB-BSF-90S-2020 | 1-1/4 Tail x 1-1/4 BSPFS 90° |
| STB-BSF-90S-2424 | 1-1/2 Tail x 1-1/2 BSPFS 90° |
| STB-BSF-90S-3232 | 2 Tail x 2 BSPFS 90° |

JIC Female Swivel 90 Degree Swept to R1/R2 Hose

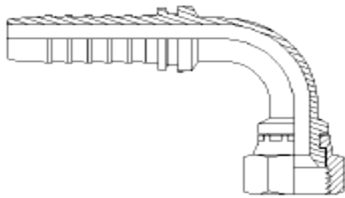

| | |
|------------------|------------------------------|
| STB-JIF-90S-0407 | 1/4 Tail x 7/16 JICFS 90° |
| STB-JIF-90S-0408 | 1/4 Tail x 1/2 JICFS 90° |
| STB-JIF-90S-0409 | 1/4 Tail x 9/16 JICFS 90° |
| STB-JIF-90S-0412 | 1/4 Tail x 3/4 JICFS 90° |
| STB-JIF-90S-0509 | 5/16 Tail x 9/16 JICFS 90° |
| STB-JIF-90S-0609 | 3/8 Tail x 9/16 JICFS 90° |
| STB-JIF-90S-0612 | 3/8 Tail x 3/4 JICFS 90° |
| STB-JIF-90S-0614 | 3/8 Tail x 7/8 JICFS 90° |
| STB-JIF-90S-0812 | 1/2 Tail x 3/4 JICFS 90° |
| STB-JIF-90S-0814 | 1/2 Tail x 7/8 JICFS 90° |
| STB-JIF-90S-0817 | 1/2 Tail x 1-1/16 JICFS 90° |
| STB-JIF-90S-1014 | 5/8 Tail x 7/8 JICFS 90° |
| STB-JIF-90S-1017 | 5/8 Tail x 1-1/16 JICFS 90° |
| STB-JIF-90S-1217 | 3/4 Tail x 1-1/16 JICFS 90° |
| STB-JIF-90S-1219 | 3/4 Tail x 1-3/16 JICFS 90° |
| STB-JIF-90S-1221 | 3/4 Tail x 1-5/16 JICFS 90° |
| STB-JIF-90S-1617 | 1 Tail x 1-1/16 JICFS 90° |
| STB-JIF-90S-1621 | 1 Tail x 1-5/16 JICFS 90° |
| STB-JIF-90S-1626 | 1 Tail x 1-5/8 JICFS 90° |
| STB-JIF-90S-2026 | 1-1/4 Tail x 1-5/8 JICFS 90° |
| STB-JIF-90S-2430 | 1-1/2 Tail x 1-7/8 JICFS 90° |
| STB-JIF-90S-3240 | 2 Tail x 2-1/2 JICFS 90° |

Metric Heavy Female 90 Degree Swept to R1/R2 Hose

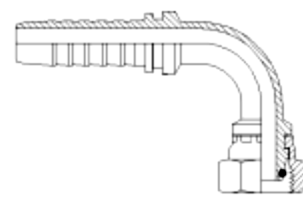

| | |
|------------------|----------------------------|
| STB-MHF-90S-0414 | 1/4 Tail x M14 Heavy 90° |
| STB-MHF-90S-0416 | 1/4 Tail x M16 Heavy 90° |
| STB-MHF-90S-0418 | 1/4 Tail x M18 Heavy 90° |
| STB-MHF-90S-0420 | 1/4 Tail x M20 Heavy 90° |
| STB-MHF-90S-0520 | 5/16 Tail x M20 Heavy 90° |
| STB-MHF-90S-0618 | 3/8 Tail x M18 Heavy 90° |
| STB-MHF-90S-0620 | 3/8 Tail x M20 Heavy 90° |
| STB-MHF-90S-0622 | 3/8 Tail x M22 Heavy 90° |
| STB-MHF-90S-0624 | 3/8 Tail x M24 Heavy 90° |
| STB-MHF-90S-0822 | 1/2 Tail x M22 Heavy 90° |
| STB-MHF-90S-0824 | 1/2 Tail x M24 Heavy 90° |
| STB-MHF-90S-1030 | 5/8 Tail x M30 Heavy 90° |
| STB-MHF-90S-1230 | 3/4 Tail x M30 Heavy 90° |
| STB-MHF-90S-1236 | 3/4 Tail x M36 Heavy 90° |
| STB-MHF-90S-1636 | 1 Tail x M36 Heavy 90° |
| STB-MHF-90S-1642 | 1 Tail x M42 Heavy 90° |
| STB-MHF-90S-2052 | 1-1/4 Tail x M52 Heavy 90° |

Metric Chinese Flat Face Female 90 Degree Swept to R1/R2 Hose

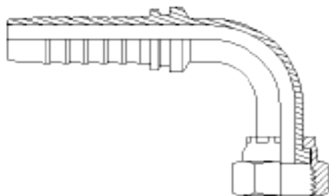

| | |
|------------------|-----------------------------------|
| STB-MCF-90S-0414 | 1/4 Tail x M14 Chinese Metric 90° |
| STB-MCF-90S-0616 | 3/8 Tail x M16 Chinese Metric 90° |
| STB-MCF-90S-0618 | 3/8 Tail x M18 Chinese Metric 90° |
| STB-MCF-90S-0822 | 1/2 Tail x M22 Chinese Metric 90° |
| STB-MCF-90S-0824 | 1/2 Tail x M24 Chinese Metric 90° |
| STB-MCF-90S-1027 | 5/8 Tail x M27 Chinese Metric 90° |
| STB-MCF-90S-1236 | 3/4 Tail x M36 Chinese Metric 90° |

Metric JIS Female (Komatsu) 90 Degree Swept to R1/R2 Hose

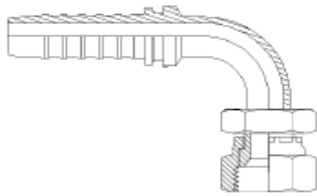

| | |
|------------------|----------------------------|
| STB-MKF-90S-0414 | 1/4 Tail x M14 Komatsu 90° |
| STB-MKF-90S-0616 | 3/8 Tail x M16 Komatsu 90° |
| STB-MKF-90S-0618 | 3/8 Tail x M18 Komatsu 90° |
| STB-MKF-90S-0620 | 3/8 Tail x M18 Komatsu 90° |
| STB-MKF-90S-0820 | 1/2 Tail x M20 Komatsu 90° |
| STB-MKF-90S-0822 | 1/2 Tail x M22 Komatsu 90° |

Metric Light Female 90 Degree Swept to R1/R2 Hose

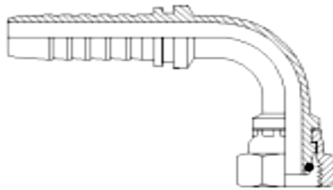

| | |
|------------------|----------------------------|
| STB-MLF-90S-0412 | 1/4 Tail x M12 Light 90° |
| STB-MLF-90S-0414 | 1/4 Tail x M14 Light 90° |
| STB-MLF-90S-0416 | 1/4 Tail x M16 Light 90° |
| STB-MLF-90S-0418 | 1/4 Tail x M18 Light 90° |
| STB-MLF-90S-0616 | 3/8 Tail x M16 Light 90° |
| STB-MLF-90S-0618 | 3/8 Tail x M18 Light 90° |
| STB-MLF-90S-0622 | 3/8 Tail x M22 Light 90° |
| STB-MLF-90S-0822 | 1/2 Tail x M22 Light 90° |
| STB-MLF-90S-0826 | 1/2 Tail - M26 Light 90° |
| STB-MLF-90S-1026 | 5/8 Tail x M26 Light 90° |
| STB-MLF-90S-1030 | 5/8 Tail x M30 Light 90° |
| STB-MLF-90S-1226 | 3/4 Tail x M26 Light 90° |
| STB-MLF-90S-1230 | 3/4 Tail x M30 Light 90° |
| STB-MLF-90S-1636 | 1 Tail x M36 Light 90° |
| STB-MLF-90S-2045 | 1-1/4 Tail x M45 Light 90° |
| STB-MLF-90S-2452 | 1-1/2 Tail x M52 Light 90° |

Metric Multi Seal Female Swivel 90 Degree Swept to R1/R2 Hose

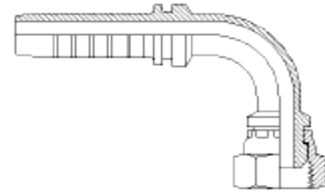

| | |
|------------------|---------------------------------------|
| STB-MMS-90S-0412 | 1/4 Tail x 12mm Metric Multi Seal 90° |
| STB-MMS-90S-0414 | 1/4 Tail x 14mm Metric Multi Seal 90° |
| STB-MMS-90S-0616 | 3/8 Tail x 16mm Metric Multi Seal 90° |
| STB-MMS-90S-0618 | 3/8 Tail x 18mm Metric Multi Seal 90° |

ORFS Female Swivel 90 Degree Swept to R1/R2 Hose

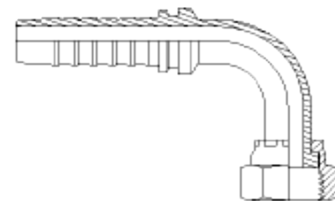

| | |
|------------------|-------------------------------|
| STB-ORF-90S-0409 | 1/4 Tail x 9/16 ORFS 90° |
| STB-ORF-90S-0411 | 1/4 Tail x 11/16 ORFS 90° |
| STB-ORF-90S-0413 | 1/4 Tail x 13/16 ORFS 90° |
| STB-ORF-90S-0609 | 3/8 Tail x 9/16 ORFS 90° |
| STB-ORF-90S-0611 | 3/8 Tail x 11/16 ORFS 90° |
| STB-ORF-90S-0613 | 3/8 Tail x 13/16 ORFS 90° |
| STB-ORF-90S-0813 | 1/2 Tail x 13/16 ORFS 90° |
| STB-ORF-90S-0816 | 1/2 Tail x 1 ORFS 90° |
| STB-ORF-90S-1016 | 5/8 Tail x 1 ORFS 90° |
| STB-ORF-90S-1019 | 5/8 Tail x 1-3/16 ORFS 90° |
| STB-ORF-90S-1216 | 3/4 Tail x 1 ORFS 90° |
| STB-ORF-90S-1219 | 3/4 Tail x 1-3/16 ORFS 90° |
| STB-ORF-90S-1223 | 3/4 Tail x 1-7/16 ORFS 90° |
| STB-ORF-90S-1623 | 1 Tail x 1-7/16 ORFS 90° |
| STB-ORF-90S-2027 | 1-1/4 Tail x 1-11/16 ORFS 90° |
| STB-ORF-90S-2432 | 1-1/2 Tail x 2 ORFS 90° |

SAE 45 Degree Female Swivel 90 Degree Swept to R1/R2 Hose

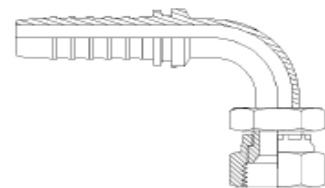

| | |
|------------------|----------------------------------|
| STB-SAF-90S-0610 | 3/8 Tail x 5/8 SAE Female 90° |
| STB-SAF-90S-1217 | 3/4 Tail x 1-1/16 SAE Female 90° |



ASSOCIATED ITEMS

Associated Items

Banjo Bolt BSPP

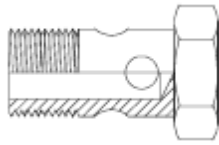

| | |
|--------|--------------------|
| BBB-02 | 1/8 BSP Banjo Bolt |
| BBB-04 | 1/4 BSP Banjo Bolt |
| BBB-06 | 3/8 BSP Banjo Bolt |
| BBB-08 | 1/2 BSP Banjo Bolt |
| BBB-12 | 3/4 BSP Banjo Bolt |
| BBB-16 | 1 BSP Banjo Bolt |

Metric Banjo Bolt

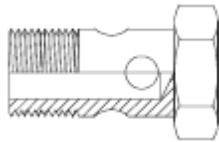

| | |
|--------|-----------------|
| MBB-10 | 10mm Banjo Bolt |
| MBB-12 | 12mm Banjo Bolt |
| MBB-14 | 14mm Banjo Bolt |
| MBB-16 | 16mm Banjo Bolt |
| MBB-18 | 18mm Banjo Bolt |
| MBB-22 | 22mm Banjo Bolt |
| MBB-26 | 26mm Banjo Bolt |

Hydraulic Oil



| | |
|---------|-------------------------------|
| HO46-20 | HYDRAULIC OIL ISO 46 20 LITRE |
| HO68-20 | HYDRAULIC OIL ISO 68 20 LITRE |

Locknuts

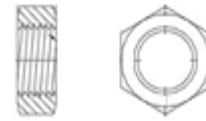

BSP

| | |
|--------|--------------------|
| BLN-04 | 1/4 BSP Lock Nut |
| BLN-06 | 3/8 BSP Lock Nut |
| BLN-08 | 1/2 BSP Lock Nut |
| BLN-12 | 3/4 BSP Lock Nut |
| BLN-16 | 1 BSP Lock Nut |
| BLN-20 | 1-1/4 BSP Lock Nut |
| BLN-24 | 1-1/2 BSP Lock Nut |

JIC

| | |
|--------|---------------------|
| JLN-07 | 7/16 JIC Lock Nut |
| JLN-08 | 1/2 JIC Lock Nut |
| JLN-09 | 9/16 JIC Lock Nut |
| JLN-12 | 3/4 JIC Lock Nut |
| JLN-14 | 7/8 JIC Lock Nut |
| JLN-17 | 1-1/16 JIC Lock Nut |
| JLN-21 | 1-5/16 JIC Lock Nut |
| JLN-26 | 1-5/8 JIC Lock Nut |
| JLN-30 | 1-7/8 JIC Lock Nut |
| JLN-40 | 2-1/2 JIC Lock Nut |

ORFS

| | |
|--------|-----------------------|
| OLN-09 | 9/16 ORFS Lock Nut |
| OLN-11 | 11/16 ORFS Lock Nut |
| OLN-13 | 13/16 ORFS Lock Nut |
| OLN-16 | 1 ORFS Lock Nut |
| OLN-19 | 1-3/16 ORFS Lock Nut |
| OLN-23 | 1-7/16 ORFS Lock Nut |
| OLN-27 | 1-11/16 ORFS Lock Nut |
| OLN-32 | 2 ORFS Lock Nut |

JIC Tube Nut



| | |
|--------|---------------------|
| JTN-07 | 7/16 JIC Tube Nut |
| JTN-08 | 1/2 JIC Tube Nut |
| JTN-09 | 9/16 JIC Tube Nut |
| JTN-12 | 3/4 JIC Tube Nut |
| JTN-14 | 7/8 JIC Tube Nut |
| JTN-17 | 1-1/16 JIC Tube Nut |
| JTN-21 | 1-5/16 JIC Tube Nut |
| JTN-26 | 1-5/8 JIC Tube Nut |
| JTN-30 | 1-7/8 JIC Tube Nut |

ORFS Tube Nut

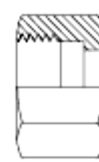

| | |
|--------|-----------------------|
| OTN-09 | 9/16 ORFS Tube Nut |
| OTN-11 | 11/16 ORFS Tube Nut |
| OTN-13 | 13/16 ORFS Tube Nut |
| OTN-16 | 1 ORFS Tube Nut |
| OTN-19 | 1-3/16 ORFS Tube Nut |
| OTN-23 | 1-7/16 ORFS Tube Nut |
| OTN-27 | 1-11/16 ORFS Tube nut |
| OTN-32 | 2 ORFS Tube nut |

JIC Tube Sleeve

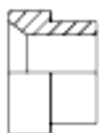

| | |
|--------|------------------------|
| JTS-07 | 7/16 JIC Tube Sleeve |
| JTS-08 | 1/2 JIC Tube Sleeve |
| JTS-09 | 9/16 JIC Tube Sleeve |
| JTS-12 | 3/4 JIC Tube Sleeve |
| JTS-14 | 7/8 JIC Tube Sleeve |
| JTS-17 | 1-1/16 JIC Tube Sleeve |
| JTS-21 | 1-5/16 JIC Tube Sleeve |
| JTS-26 | 1-5/8 JIC Tube Sleeve |
| JTS-30 | 1-7/8 JIC Tube Sleeve |

T-Bolt Super Clamps

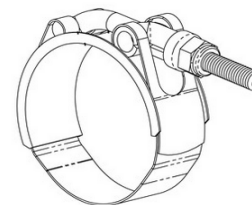

| | |
|-----------|----------------------|
| SC-2325 | CLAMP BAND 23-25MM |
| SC-2527 | CLAMP BAND 25-27MM |
| SC-2931 | CLAMP BAND 29-31MM |
| SC-3033 | CLAMP BAND 30-33MM |
| SC-3134 | CLAMP BAND 31-34MM |
| SC-3437 | CLAMP BAND 34-37MM |
| SC-3639 | CLAMP BAND 36-39MM |
| SC-3740 | CLAMP BAND 37-40MM |
| SC-4043 | CLAMP BAND 40-43MM |
| SC-4447 | CLAMP BAND 44-47MM |
| SC-4751 | CLAMP BAND 47-51MM |
| SC-5255 | CLAMP BAND 52-55MM |
| SC-6063 | CLAMP BAND 60-63MM |
| SC-6368 | CLAMP BAND 63-68MM |
| SC-6873 | CLAMP BAND 68-73MM |
| SC-7379 | CLAMP BAND 73-79MM |
| SC-7783 | CLAMP BAND 77-83MM |
| SC-8591 | CLAMP BAND 85-91MM |
| SC-112121 | CLAMP BAND 112-121MM |
| SC-162174 | CLAMP BAND 162-174MM |
| SC-175187 | CLAMP BAND 175-187MM |

Flange Block

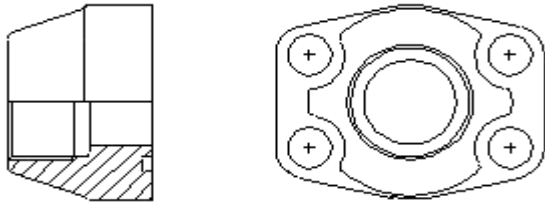

Code 61

| | |
|-----------|------------------------------|
| FB-F61-12 | Flange Block C61 3/4" BSPF |
| FB-F61-16 | Flange Block C61 1" BSPF |
| FB-F61-20 | Flange Block C61 1-1/4" BSPF |
| FB-F61-24 | Flange Block C61 1-1/2" BSPF |
| FB-F61-32 | Flange Block C61 2" BSPF |

Code 62

| | |
|-----------|------------------------------|
| FB-F62-12 | Flange Block C62 3/4" BSPF |
| FB-F62-16 | Flange Block C62 1" BSPF |
| FB-F62-20 | Flange Block C62 1-1/4" BSPF |
| FB-F62-24 | Flange Block C62 1-1/2" BSPF |
| FB-F62-32 | Flange Block C62 2" BSPF |

Flange Blanking Plate

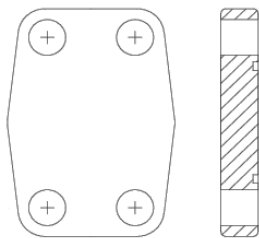

Code 61

| | |
|--------------|-----------------------------|
| F61-PLATE-12 | 3/4" Code 61 Flange Plate |
| F61-PLATE-16 | 1" Code 61 Flange Plate |
| F61-PLATE-20 | 1-1/4" Code 61 Flange Plate |
| F61-PLATE-24 | 1-1/2" Code 61 Flange Plate |
| F61-PLATE-32 | 2" Code 61 Flange Plate |

Code 62

| | |
|--------------|-----------------------------|
| F62-PLATE-12 | 3/4" Code 62 Flange Plate |
| F62-PLATE-16 | 1" Code 62 Flange Plate |
| F62-PLATE-20 | 1-1/4" Code 62 Flange Plate |
| F62-PLATE-24 | 1-1/2" Code 62 Flange Plate |
| F62-PLATE-32 | 2" Code 62 Flange Plate |

Code 61 Split Flange Clamp

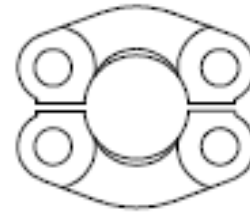

| | |
|------------|-----------------------------|
| CLS-F61-08 | 1/2 Code 61 Flange Clamps |
| CLS-F61-12 | 3/4 Code 61 Flange Clamps |
| CLS-F61-16 | 1 Code 61 Flange Clamps |
| CLS-F61-20 | 1-1/4 Code 61 Flange Clamps |
| CLS-F61-24 | 1-1/2 Code 61 Flange Clamps |
| CLS-F61-32 | 2 Code 61 Flange Clamps |
| CLS-F61-40 | 2-1/2 Code 61 Flange Clamps |
| CLS-F61-48 | 3 Code 61 Flange Clamps |

Code 62 Split Flange Clamp

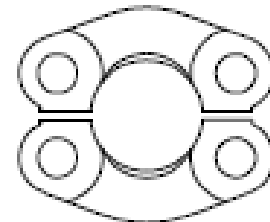

| | |
|------------|-----------------------------|
| CLS-F62-08 | 1/2 Code 62 Flange Clamps |
| CLS-F62-12 | 3/4 Code 62 Flange Clamps |
| CLS-F62-16 | 1 Code 62 Flange Clamps |
| CLS-F62-20 | 1-1/4 Code 62 Flange Clamps |
| CLS-F62-24 | 1-1/2 Code 62 Flange Clamps |
| CLS-F62-32 | 2 Code 62 Flange Clamps |

CAT Flange Spacer Ring

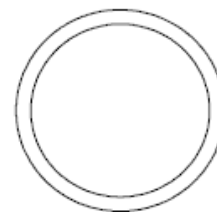

| | |
|------------|-----------------------|
| CAT-F62-12 | 3/4 Cat Flange Ring |
| CAT-F62-16 | 1 Cat Flange Ring |
| CAT-F62-20 | 1-1/4 Cat Flange Ring |
| CAT-F62-24 | 1-1/2 Cat Flange Ring |
| CAT-F62-32 | 2 Cat Flange Ring |

Single Tube Clamps

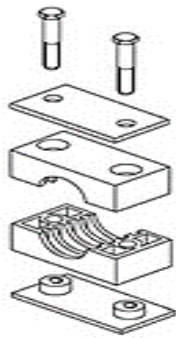

Heavy Duty Single Tube Clamps

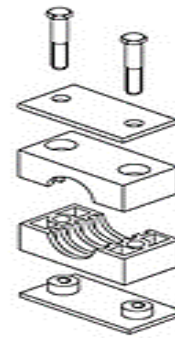

| | |
|-----------|---------------------|
| RTCS-06 | 6MM CLAMP SINGLE |
| RTCS-06.4 | 6.4MM CLAMP SINGLE |
| RTCS-08 | 8MM CLAMP SINGLE |
| RTCS-09.5 | 9.5MM CLAMP SINGLE |
| RTCS-10 | 10MM CLAMP SINGLE |
| RTCS-12 | 12MM CLAMP SINGLE |
| RTCS-12.7 | 12.7MM CLAMP SINGLE |
| RTCS-14 | 14MM CLAMP SINGLE |
| RTCS-15 | 15MM CLAMP SINGLE |
| RTCS-16 | 16MM CLAMP SINGLE |
| RTCS-18 | 18MM CLAMP SINGLE |
| RTCS-19 | 19MM CLAMP SINGLE |
| RTCS-20 | 20MM CLAMP SINGLE |
| RTCS-21.3 | 21.3MM CLAMP SINGLE |
| RTCS-22 | 22MM CLAMP SINGLE |
| RTCS-25.4 | 25MM CLAMP SINGLE |
| RTCS-26.9 | 26.9MM CLAMP SINGLE |
| RTCS-28 | 28MM CLAMP SINGLE |
| RTCS-30 | 30MM CLAMP SINGLE |
| RTCS-32 | 32MM CLAMP SINGLE |
| RTCS-33.7 | 33.7MM CLAMP SINGLE |
| RTCS-35 | 35MM CLAMP SINGLE |
| RTCS-38 | 38MM CLAMP SINGLE |
| RTCS-40 | 40MM CLAMP SINGLE |
| RTCS-42 | 42MM CLAMP SINGLE |
| RTCS-44.5 | 44.5MM CLAMP SINGLE |
| RTCS-48.3 | 48.3MM CLAMP SINGLE |
| RTCS-50.8 | 50.8MM CLAMP SINGLE |

| | |
|-------------|---------------------|
| RTCS-10HD | 10MM CLAMP SINGLE |
| RTCS-12.7HD | 12.7MM CLAMP SINGLE |
| RTCS-14HD | 14MM CLAMP SINGLE |
| RTCS-15HD | 15MM CLAMP SINGLE |
| RTCS-16HD | 16MM CLAMP SINGLE |
| RTCS-18HD | 18MM CLAMP SINGLE |
| RTCS-19HD | 19MM CLAMP SINGLE |
| RTCS-20HD | 20MM CLAMP SINGLE |
| RTCS-21.3HD | 21.3MM CLAMP SINGLE |
| RTCS-22HD | 22MM CLAMP SINGLE |
| RTCS-25.4HD | 25MM CLAMP SINGLE |
| RTCS-28HD | 28MM CLAMP SINGLE |
| RTCS-30HD | 30MM CLAMP SINGLE |
| RTCS-32HD | 32MM CLAMP SINGLE |
| RTCS-33.7HD | 33.7MM CLAMP SINGLE |
| RTCS-38HD | 38MM CLAMP SINGLE |
| RTCS-42HD | 42MM CLAMP SINGLE |
| RTCS-50.8HD | 50.8MM CLAMP SINGLE |

Twin Tube Clamps



| | |
|-----------|---------------------|
| RTCT-06 | 6MM CLAMP DOUBLE |
| RTCT-06.4 | 6.4MM CLAMP DOUBLE |
| RTCT-08 | 8MM CLAMP DOUBLE |
| RTCT-09.5 | 9.5MM CLAMP DOUBLE |
| RTCT-10 | 10MM CLAMP DOUBLE |
| RTCT-12 | 12MM CLAMP DOUBLE |
| RTCT-12.7 | 12.7MM CLAMP DOUBLE |
| RTCT-14 | 14MM CLAMP DOUBLE |
| RTCT-15 | 15MM CLAMP DOUBLE |
| RTCT-16 | 16MM CLAMP DOUBLE |
| RTCT-17.2 | 17.2MM CLAMP DOUBLE |
| RTCT-18 | 18MM CLAMP DOUBLE |
| RTCT-19 | 19MM CLAMP DOUBLE |
| RTCT-20 | 20MM CLAMP DOUBLE |
| RTCT-21.3 | 21.3MM CLAMP DOUBLE |
| RTCT-22 | 22MM CLAMP DOUBLE |
| RTCT-25.4 | 25MM CLAMP DOUBLE |
| RTCT-26.9 | 26.9MM CLAMP DOUBLE |
| RTCT-28 | 28MM CLAMP DOUBLE |
| RTCT-30 | 30MM CLAMP DOUBLE |
| RTCT-32 | 32MM CLAMP DOUBLE |
| RTCT-35 | 35MM CLAMP DOUBLE |
| RTCT-38 | 38MM CLAMP DOUBLE |
| RTCT-42 | 42MM CLAMP DOUBLE |

Hydraulic Tube



Metric

| | |
|-----------------|--------------------------------|
| HT-6MM X 1MM | TUBE 6MM X 1MM ZINC PLATED |
| HT-8MM X 1.5MM | TUBE 8MM X 1.5MM ZINC PLATED |
| HT-10MM X 1.5MM | TUBE 10MM X 1.5MM ZINC PLATED |
| HT-12MM X 1.5MM | TUBE 12MM X 1.5MM ZINC PLATED |
| HT-14MM X 2MM | TUBE 14MM X 2MM ZINC PLATED |
| HT-15MM X 1.5MM | TUBE 15MM X 1.5MM ZINC PLATED |
| HT-16MM X 2.0MM | TUBE 16MM X 2.0MM ZINC PLATED |
| HT-18MM X 2MM | TUBE 18MM X 2.03MM ZINC PLATED |
| HT-20MM X 2.5MM | TUBE 20MM X 2.5MM ZINC PLATED |
| HT-25MM X 2.5MM | TUBE 25MM X 2.5MM ZINC PLATED |

Imperial

| | |
|-------------------|--------------------------------|
| HT-1/4 X 0.91MM | TUBE 1/4 X 0.91MM ZINC PLATED |
| HT-3/8 X 1.63MM | TUBE 3/8 X 1.63MM ZINC PLATED |
| HT-1/2 X 1.63MM | TUBE 1/2 X 1.63MM ZINC PLATED |
| HT-5/8 X 1.63MM | TUBE 5/8 X 1.63MM ZINC PLATED |
| HT-3/4 X 2.03MM | TUBE 3/4 X 2.03MM ZINC PLATED |
| HT-3/4 X 2.64MM | TUBE 3/4 X 2.64MM ZINC PLATED |
| HT-1 X 1.63MM | TUBE 1 X 1.63MM ZINC PLATED |
| HT-1 X 2.64MM | TUBE 1 X 2.64MM ZINC PLATED |
| HT-1 1/4 X 1.63MM | TUBE 1-1/4 X 1.63MM ZINC PLATE |
| HT-1 1/4 X 2.64MM | TUBE 1-1/4 X 2.64MM ZINC PLATE |

O'Rings



BSP

| | |
|-----------|-------------------|
| OR-BSP-02 | O Ring BSPP 1/8 |
| OR-BSP-04 | O Ring BSPP 1/4 |
| OR-BSP-06 | O Ring BSPP 3/8 |
| OR-BSP-08 | O Ring BSPP 1/2 |
| OR-BSP-12 | O Ring BSPP 3/4 |
| OR-BSP-16 | O Ring BSPP 1 |
| OR-BSP-20 | O Ring BSPP 1-1/4 |
| OR-BSP-24 | O Ring BSPP 1-1/2 |
| OR-BSP-32 | O Ring BSPP 2 |

ORFS

| | |
|-----------|---------------------|
| OR-ORF-09 | O Ring 9/16 ORFS |
| OR-ORF-11 | O Ring 11/16 ORFS |
| OR-ORF-13 | O Ring 13/16 ORFS |
| OR-ORF-16 | O Ring 1 ORFS |
| OR-ORF-19 | O Ring 1-3/16 ORFS |
| OR-ORF-23 | O Ring 1-7/16 ORFS |
| OR-ORF-27 | O Ring 1-11/16 ORFS |
| OR-ORF-32 | O Ring 2 ORFS |

SAE

| | |
|-----------|-------------------------|
| OR-SAE-08 | O Ring SAE 1/2 Flange |
| OR-SAE-12 | O Ring SAE 3/4 Flange |
| OR-SAE-16 | O Ring SAE 1 Flange |
| OR-SAE-20 | O Ring SAE 1-1/4 Flange |
| OR-SAE-24 | O Ring SAE 1-1/2 Flange |
| OR-SAE-32 | O Ring SAE 2 Flange |
| OR-SAE-40 | O Ring SAE 2-1/2 Flange |

UNO

| | |
|-----------|-------------------|
| OR-UNO-07 | O Ring 7/16 UNO |
| OR-UNO-08 | O Ring 1/2 UNO |
| OR-UNO-09 | O Ring 9/16 UNO |
| OR-UNO-12 | O Ring 3/4 UNO |
| OR-UNO-14 | O Ring 7/8 UNO |
| OR-UNO-17 | O Ring 1-1/16 UNO |
| OR-UNO-21 | O Ring 1-5/16 UNO |
| OR-UNO-26 | O Ring 1-5/8 UNO |
| OR-UNO-30 | O Ring 1-7/8 UNO |
| OR-UNO-40 | O Ring 2-1/2 UNO |

BSP Dowty Seal



| | |
|--------|----------------------|
| DSB-02 | 1/8 BSP Dowty Seal |
| DSB-04 | 1/4 BSP Dowty Seal |
| DSB-06 | 3/8 BSP Dowty Seal |
| DSB-08 | 1/2 BSP Dowty Seal |
| DSB-10 | 5/8 BSP Dowty Seal |
| DSB-12 | 3/4 BSP Dowty Seal |
| DSB-16 | 1 BSP Dowty Seal |
| DSB-20 | 1-1/4 BSP Dowty Seal |
| DSB-24 | 1-1/2 BSP Dowty Seal |
| DSB-32 | 2 BSP Dowty Seal |

Metric Dowty Seal

| | |
|--------|------------------------|
| DSM-10 | 10mm Metric Dowty Seal |
| DSM-12 | 12mm Metric Dowty Seal |
| DSM-14 | 14mm Metric Dowty Seal |
| DSM-16 | 16mm Metric Dowty Seal |
| DSM-18 | 18mm Metric Dowty Seal |
| DSM-20 | 20mm Metric Dowty Seal |
| DSM-22 | 22mm Metric Dowty Seal |
| DSM-24 | 24mm Metric Dowty Seal |
| DSM-26 | 26mm Metric Dowty Seal |
| DSM-27 | 27mm Metric Dowty Seal |
| DSM-30 | 30mm Metric Dowty Seal |
| DSM-33 | 33mm Metric Dowty Seal |
| DSM-36 | 36mm Metric Dowty Seal |
| DSM-42 | 42mm Metric Dowty Seal |
| DSM-48 | 48mm Metric Dowty Seal |

Encapsulated Seal



| | |
|--------|--------------------------------|
| EDB-02 | Encapsulated O Ring BSPP 1/8 |
| EDB-04 | Encapsulated O Ring BSPP 1/4 |
| EDB-06 | Encapsulated O Ring BSPP 3/8 |
| EDB-08 | Encapsulated O Ring BSPP 1/2 |
| EDB-12 | Encapsulated O Ring BSPP 3/4 |
| EDB-16 | Encapsulated O Ring BSPP 1 |
| EDB-20 | Encapsulated O Ring BSPP 1-1/4 |
| EDB-24 | Encapsulated O Ring BSPP 1-1/2 |

BSP Inline Check Valve

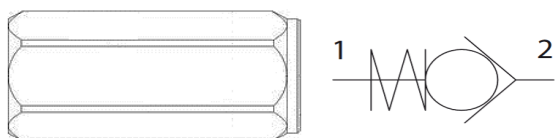

| | |
|-------|-------------------|
| CV-02 | 1/8 CHECK VALVE |
| CV-04 | 1/4 CHECK VALVE |
| CV-06 | 3/8 CHECK VALVE |
| CV-08 | 1/2 CHECK VALVE |
| CV-12 | 3/4 CHECK VALVE |
| CV-16 | 1 CHECK VALVE |
| CV-20 | 1-1/4 CHECK VALVE |
| CV-24 | 1-1/2 CHECK VALVE |

BSP High Pressure Ball Valve

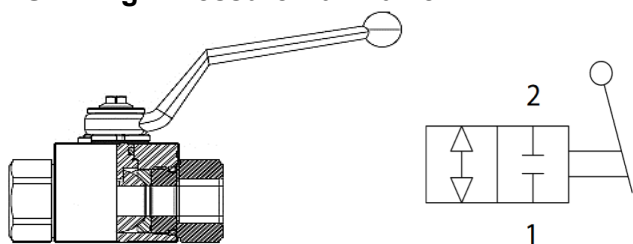

| | |
|-------|--------------------------|
| BV-04 | 1/4 BALL VALVE 500 BAR |
| BV-06 | 3/8 BALL VALVE 500 BAR |
| BV-08 | 1/2 BALL VALVE 500 BAR |
| BV-12 | 3/4 BALL VALVE 400 BAR |
| BV-16 | 1 BALL VALVE 350 BAR |
| BV-20 | 1-1/4 BALL VALVE 350 BAR |
| BV-24 | 1-1/2 BALL VALVE 350 BAR |

BSP Low Pressure Ball Valve

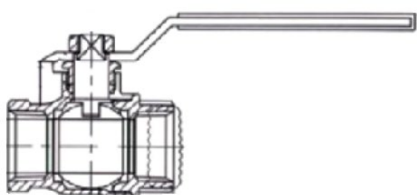

| | |
|---------|-------------------------------|
| LPBV-04 | 1/4 BRASS BALL VALVE 40 BAR |
| LPBV-06 | 3/8 BRASS BALL VALVE 40 BAR |
| LPBV-08 | 1/2 BRASS BALL VALVE 40 BAR |
| LPBV-12 | 3/4 BRASS BALL VALVE 40 BAR |
| LPBV-16 | 1 BRASS BALL VALVE 40 BAR |
| LPBV-20 | 1-1/4 BRASS BALL VALVE 40 BAR |
| LPBV-24 | 1-1/2 BRASS BALL VALVE 40 BAR |
| LPBV-32 | 2 BRASS BALL VALVE 40 BAR |

BSP Rotating Couplings (Live Swivels)

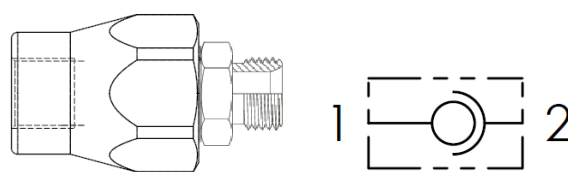

Straight

| | |
|---------|-----------------------|
| GGIL140 | 1/4 BSPP M/F SWIVEL |
| GGIL380 | 3/8 BSPP M/F SWIVEL |
| GGIL120 | 1/2 BSPP M/F SWIVEL |
| GGIL340 | 3/4 BSPP M/F SWIVEL |
| GGIL100 | 1 BSPP M/F SWIVEL |
| GGIL114 | 1-1/4 BSPP M/F SWIVEL |

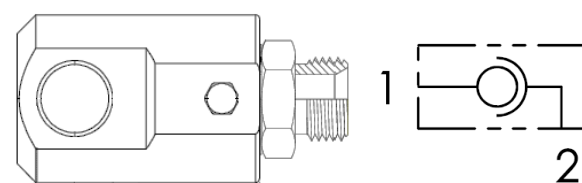

90°

| | |
|---------|--------------------------------|
| GG90140 | 1/4 BSPP 90° ROTATING SWIVEL |
| GG90380 | 3/8 BSPP 90° ROTATING SWIVEL |
| GG90120 | 1/2 BSPP 90° ROTATING SWIVEL |
| GG90340 | 3/4 BSPP 90° ROTATING SWIVEL |
| GG90100 | 1 BSPP 90° ROTATING SWIVEL |
| GG90114 | 1-1/4 BSPP 90° ROTATING SWIVEL |

Flow Control Valve with Reverse Flow Check BSPP

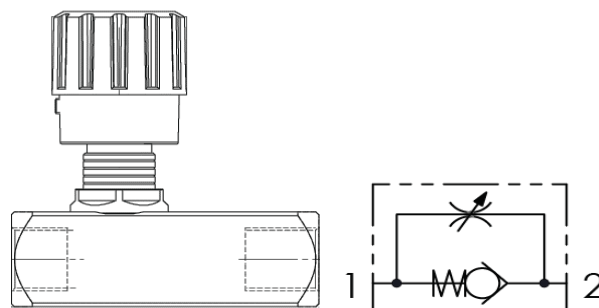

| | |
|--------|--------------------------------|
| FCV-04 | 1/4 FLOW CONTROL VALVE CHECKED |
| FCV-06 | 3/8 FLOW CONTROL VALVE CHECKED |
| FCV-08 | 1/2 FLOW CONTROL VALVE CHECKED |

Spiral Guard



| AVAILABLE IN 20MT BOXES (COLOURS P.O.A) | |
|---|--------------------------------|
| R9SSG | 9mm Pigs Tail Black (50mt box) |
| R12SSG | 12mm Pigs Tail Black |
| R16SSG | 16mm Pigs Tail Black |
| R20SSG | 20mm Pigs Tail Black |
| R25SSG | 25mm Pigs Tail Black |
| R32SSG | 32mm Pigs Tail Black |
| R40SSG | 40mm Pigs Tail Black |
| R50SSG | 50mm Pigs Tail Black |
| R63SSG | 63mm Pigs Tail Black |
| R75SSG | 75mm Pigs Tail Black |
| R90SSG | 90mm Pigs Tail Black |

Spring Guard



| AVAILABLE IN 6MT LENGTHS | |
|--------------------------|----------------------------|
| SG-6.4 | SPING GUARD 6.4MM ID (3MT) |
| SG-17 | SPING GUARD 17MM ID |
| SG-21 | SPING GUARD 21MM ID |
| SG-23 | SPING GUARD 23MM ID |
| SG-27 | SPING GUARD 27MM ID |
| SG-31 | SPING GUARD 31MM ID |
| SG-34 | SPING GUARD 34MM ID |
| SG-41 | SPING GUARD 41MM ID |
| SG-49 | SPING GUARD 49MM ID |

Anti-Abrasion Burst Sleeve



| AVAILABLE IN CUT OR 50MT LENGTHS | |
|----------------------------------|-----------------------------|
| AAS-20 | 20mm Burst Sleeve 10mm ID |
| AAS-25 | 25mm Burst Sleeve 14mm ID |
| AAS-31 | 31mm Burst Sleeve 17mm ID |
| AAS-36 | 36mm Burst Sleeve 20mm ID |
| AAS-40 | 40mm Burst Sleeve 23mm ID |
| AAS-45 | 45mm Burst Sleeve 25mm ID |
| AAS-50 | 50mm Burst Sleeve 31mm ID |
| AAS-55 | 55mm Burst Sleeve 36mm ID |
| AAS-65 | 65mm Burst Sleeve 40mm ID |
| AAS-71 | 71mm Burst Sleeve 44mm ID |
| AAS-85 | 85mm Burst Sleeve 53mm ID |
| AAS-93 | 93mm Burst Sleeve 56mm ID |
| AAS-104 | 104mm Burst Sleeve 66mm ID |
| AAS-110 | 110mm Burst Sleeve 72mm ID |
| AAS-120 | 120mm Burst Sleeve 78mm ID |
| AAS-145 | 145mm Burst Sleeve 90mm ID |
| AAS-176 | 176mm Burst Sleeve 112mm ID |

Waterproof Velcro Fast Sleeve



| AVAILABLE IN 25MT LENGTHS | |
|---------------------------|--------------------------------|
| FS-12 | Waterproof Fast Sleeve 12mm ID |
| FS-16 | Waterproof Fast Sleeve 16mm ID |
| FS-20 | Waterproof Fast Sleeve 20mm ID |
| FS-25 | Waterproof Fast Sleeve 25mm ID |
| FS-30 | Waterproof Fast Sleeve 30mm ID |
| FS-40 | Waterproof Fast Sleeve 40mm ID |
| FS-50 | Waterproof Fast Sleeve 50mm ID |
| FS-60 | Waterproof Fast Sleeve 60mm ID |

Fire Proof Sleeve



| AVAILABLE IN CUT OR 20MT LENGTHS | |
|----------------------------------|---------------------------|
| FPS-20 | Fire Proof Sleeve 20mm ID |
| FPS-25 | Fire Proof Sleeve 25mm ID |
| FPS-30 | Fire Proof Sleeve 30mm ID |
| FPS-40 | Fire Proof Sleeve 40mm ID |
| FPS-50 | Fire Proof Sleeve 50mm ID |

Service Plug Kits



| | |
|--------|-------------------------------------|
| SP-001 | SERVICE PLUG KIT - 1 TO 10 (20 PCE) |
| SP-002 | SERVICE PLUG KIT - 5 TO 22 (10 PCE) |
| SP-003 | SERVICE PLUG KIT - 13 TO 42 (4 PCE) |
| SP-004 | SERVICE PLUG KIT - MIX 10 PCE |

PVC P-Clamp



| | |
|-----------|---|
| RCPP-6.3 | 6.3mm (1/4") P-Clamp PVC - 19mm Band |
| RCPP-9.6 | 9.6mm (3/8") P-Clamp PVC - 19mm Band |
| RCPP-11.1 | 11.1mm (7/16") P-Clamp PVC - 19mm Band |
| RCPP-12.7 | 12.7mm (1/2") P-Clamp PVC - 19mm Band |
| RCPP-14.3 | 14.3mm (9/16") P-Clamp PVC - 19mm Band |
| RCPP-15.9 | 15.9mm (5/8") P-Clamp PVC - 19mm Band |
| RCPP-17.5 | 17.5mm (11/16") P-Clamp PVC - 19mm Band |
| RCPP-19.1 | 19.1mm (3/4") P-Clamp PVC - 19mm Band |
| RCPP-20.6 | 20.6mm (13/16") P-Clamp PVC - 19mm Band |
| RCPP-23.9 | 23.9mm (15/16") P-Clamp PVC - 19mm Band |
| RCPP-25.4 | 25.4mm (1") P-Clamp PVC - 19mm Band |

A technical drawing of a stainless steel component, possibly a valve or a pipe fitting, rendered in a light gray line-art style. The drawing shows a complex, multi-part assembly with various diameters, flanges, and a curved section. The lines are thin and precise, typical of engineering drawings. The background is a dark gray, and the text 'STAINLESS STEEL' is centered in the middle of the image in a bold, white, sans-serif font.

STAINLESS STEEL

Straight Adaptors

BSPP Male x JIC Male Nipple S/S

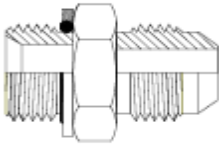

| | |
|----------------|----------------------------|
| S-BPM-JIM-0407 | 1/4 BSPPM x 7/16 JICM SS |
| S-BPM-JIM-0409 | 1/4 BSPPM x 9/16 JICM SS |
| S-BPM-JIM-0609 | 3/8 BSPPM x 9/16 JICM SS |
| S-BPM-JIM-0612 | 3/8 BSPPM x 3/4 JICM SS |
| S-BPM-JIM-0807 | 1/2 BSPPM x 7/16 JICM SS |
| S-BPM-JIM-0809 | 1/2 BSPPM x 9/16 JICM SS |
| S-BPM-JIM-0812 | 1/2 BSPPM X 3/4 JICM SS |
| S-BPM-JIM-0814 | 1/2 BSPPM X 7/8 JICM SS |
| S-BPM-JIM-1214 | 3/4 BSPPM x 7/8 JICM SS |
| S-BPM-JIM-1217 | 3/4 BSPPM x 1-1/16 JICM SS |
| S-BPM-JIM-1621 | 1 BSPPM x 1-5/16 JICM SS |

BSPT Male x BSPT Male Nipple S/S

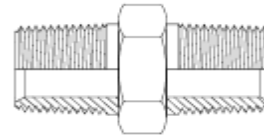

| | |
|----------------|------------------------------|
| S-BTM-BTM-0404 | 1/4 BSPTM x 1/4 BSPTM SS |
| S-BTM-BTM-0606 | 3/8 BSPTM x 3/8 BSPTM SS |
| S-BTM-BTM-0808 | 1/2 BSPTM x 1/2 BSPTM SS |
| S-BTM-BTM-1212 | 3/4 BSPTM x 3/4 BSPTM SS |
| S-BTM-BTM-1616 | 1 BSPTM x 1 BSPTM SS |
| S-BTM-BTM-2020 | 1-1/4 BSPTM x 1-1/4 BSPTM SS |

JIC Male x JIC Male Nipple S/S

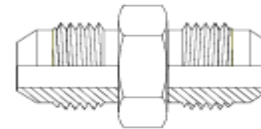

| | |
|----------------|------------------------------|
| S-JIM-JIM-0707 | 7/16 JICM x 7/16 JICM SS |
| S-JIM-JIM-0909 | 9/16 JICM x 9/16 JICM SS |
| S-JIM-JIM-1212 | 3/4 JICM x 3/4 JICM SS |
| S-JIM-JIM-1414 | 7/8 JICM x 7/8 JICM SS |
| S-JIM-JIM-1717 | 1-1/16 JICM x 1-1/16 JICM SS |
| S-JIM-JIM-2121 | 1-5/16 JICM x 1-5/16 JICM SS |

90 Degree

BSPP Male x BSPP Female Swivel 90 Degree S/S

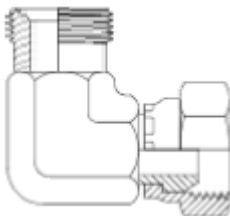

| | |
|--------------------|------------------------------|
| S-BPM-BSF-90C-0404 | 1/4 BSPPM x 1/4 BSPFS 90° SS |
| S-BPM-BSF-90C-0606 | 3/8 BSPPM x 3/8 BSPFS 90° SS |
| S-BPM-BSF-90C-0808 | 1/2 BSPPM x 1/2 BSPFS 90° SS |
| S-BPM-BSF-90C-1212 | 3/4 BSPPM x 3/4 BSPFS 90° SS |
| S-BPM-BSF-90C-1616 | 1 BSPPM x 1 BSPFS 90° SS |

Bulkhead

BSPP Male x BSPP Bulkhead S/S

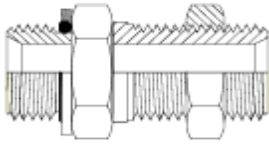

| | |
|----------------|----------------------|
| S-BPM-BBM-0404 | 1/4 BSPP Bulkhead SS |
| S-BPM-BBM-0606 | 3/8 BSPP Bulkhead SS |
| S-BPM-BBM-0808 | 1/2 BSPP Bulkhead SS |
| S-BPM-BBM-1212 | 3/4 BSPP Bulkhead SS |
| S-BPM-BBM-1616 | 1 BSPP Bulkhead SS |

JIC Male x JIC Male Bulkhead SS

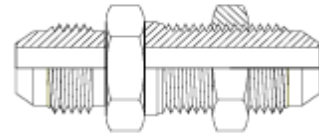

| | |
|----------------|-------------------------|
| S-JIM-JBM-0707 | 7/16 JICM Bulkhead SS |
| S-JIM-JBM-0909 | 9/16 JICM Bulkhead SS |
| S-JIM-JBM-1212 | 3/4 JICM Bulkhead SS |
| S-JIM-JBM-1414 | 7/8 JICM Bulkhead SS |
| S-JIM-JBM-1717 | 1-1/16 JICM Bulkhead SS |
| S-JIM-JBM-2121 | 1-5/16 JICM Bulkhead SS |

Caps & Plugs

JIC Female Cap S/S

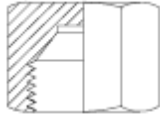

| | |
|----------|--------------------|
| S-JIF-07 | 7/16 JICF Cap SS |
| S-JIF-09 | 9/16 JICF Cap SS |
| S-JIF-12 | 3/4 JICF Cap SS |
| S-JIF-14 | 7/8 JICF Cap SS |
| S-JIF-17 | 1-1/16 JICF Cap SS |
| S-JIF-21 | 1-5/16 JICF Cap SS |

JIC Male Plug SS

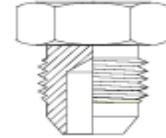

| | |
|----------|---------------------|
| S-JIM-07 | 7/16 JICM Plug SS |
| S-JIM-09 | 9/16 JICM Plug SS |
| S-JIM-12 | 3/4 JICM Plug SS |
| S-JIM-14 | 7/8 JICM Plug SS |
| S-JIM-17 | 1-1/16 JICM Plug SS |
| S-JIM-21 | 1-5/16 JICM Plug SS |

Associated Items

BSP Locknut S/S

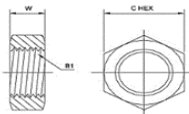

| | |
|----------|---------------------|
| S-BLN-04 | 1/4 BSP Lock Nut SS |
| S-BLN-06 | 3/8 BSP Lock Nut SS |
| S-BLN-08 | 1/2 BSP Lock Nut SS |
| S-BLN-12 | 3/4 BSP Lock Nut SS |
| S-BLN-16 | 1 BSP Lock Nut SS |

Ferrules

S/S Ferrule for SAE 100R2AT / EN853 Hose

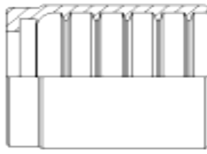

| | |
|------------|-----------------------------|
| S-SN02-04N | 1/4 Swage Ferrule R2AT SS |
| S-SN02-06N | 3/8 Swage Ferrule R2AT SS |
| S-SN02-08N | 1/2 Swage Ferrule R2AT SS |
| S-SN02-12N | 3/4 Swage Ferrule R2AT SS |
| S-SN02-16N | 1 Swage Ferrule R2AT SS |
| S-SN02-20N | 1-1/4 Swage Ferrule R2AT SS |

Ferrule for SAE 100R14 Teflon Hose



| | |
|---------|-----------------------|
| S-ST-04 | 1/4 Teflon Ferrule SS |
| S-ST-06 | 3/8 Teflon Ferrule SS |
| S-ST-08 | 1/2 Teflon Ferrule SS |
| S-ST-10 | 5/8 Teflon Ferrule SS |
| S-ST-12 | 3/4 Teflon Ferrule SS |
| S-ST-16 | 1 Teflon Ferrule SS |

Two Piece Hosetails

S/S BSPP Female Swivel to R1/R2 Hose

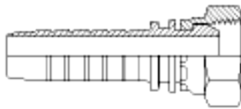

| | |
|----------------|-----------------------------|
| S-STB-BSF-0404 | 1/4 Tail x 1/4 BSPF SS |
| S-STB-BSF-0606 | 3/8 Tail x 3/8 BSPFS SS |
| S-STB-BSF-0808 | 1/2 Tail x 1/2 BSPF SS |
| S-STB-BSF-1212 | 3/4 Tail x 3/4 BSPF SS |
| S-STB-BSF-1216 | 3/4 Tail x 1 BSPF SS |
| S-STB-BSF-1616 | 1 Tail x 1 BSPF SS |
| S-STB-BSF-2020 | 1-1/4 Tail x 1-1/4 BSPFS SS |

S/S JIC Female Swivel to R1/R2 Hose

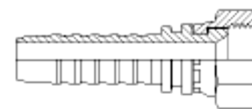

| | |
|----------------|---------------------------|
| S-STB-JIF-0407 | 1/4 Tail x 7/16 JICF SS |
| S-STB-JIF-0409 | 1/4 Tail x 9/16 JICFS SS |
| S-STB-JIF-0609 | 3/8 Tail x 9/16 JICF SS |
| S-STB-JIF-0612 | 3/8 Tail x 3/4 JICF SS |
| S-STB-JIF-0812 | 1/2 Tail x 3/4 JICF SS |
| S-STB-JIF-0814 | 1/2 Tail x 7/8 JICF SS |
| S-STB-JIF-1014 | 5/8 Tail x 7/8 JICF SS |
| S-STB-JIF-1217 | 3/4 Tail x 1-1/16 JICF SS |
| S-STB-JIF-1621 | 1 Tail x 1-5/16 JICF SS |

S/S BSPT Male to R1/R2 Hose

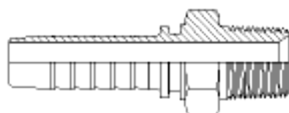

| | |
|----------------|-------------------------|
| S-STB-BTM-0404 | 1/4 Tail x 1/4 BSPTM SS |
| S-STB-BTM-0606 | 3/8 Tail x 3/8 BSPTM SS |
| S-STB-BTM-0808 | 1/2 Tail x 1/2 BSPTM SS |
| S-STB-BTM-1212 | 3/4 Tail x 3/4 BSPTM SS |
| S-STB-BTM-1216 | 3/4 Tail x 1 BSPTM SS |
| S-STB-BTM-1616 | 1 Tail x 1 BSPTM SS |

SS BSPP Female Swivel 90 Swept to R1/R2 Hose

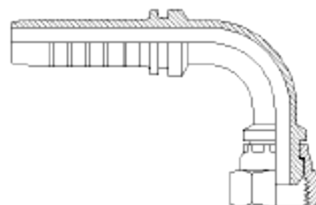

| | |
|--------------------|-----------------------------|
| S-STB-BSF-90S-0404 | 1/4 Tail x 1/4 BSPFS 90° SS |
| S-STB-BSF-90S-0606 | 3/8 Tail x 3/8 BSPFS 90° SS |
| S-STB-BSF-90S-0808 | 1/2 Tail x 1/2 BSPFS 90° SS |
| S-STB-BSF-90S-1212 | 3/4 Tail x 3/4 BSPFS 90° SS |
| S-STB-BSF-90S-1616 | 1 Tail x 1 BSPFS 90° SS |

A technical drawing of a hydraulic hose assembly, rendered in a light blue color on a dark blue background. The drawing shows a hose with a braided reinforcement layer and a protective outer jacket, connected to a metal fitting. The drawing is a perspective view, showing the hose and fitting from an angle. The text "HYDRAULIC HOSE" is centered over the drawing in a bold, white, sans-serif font.

HYDRAULIC HOSE

Hydraulic Hose

GATES PRO SERIES CR1 (SAE 100 R1AT - EN 853 1SN)



- Cover** Black, abrasion resistant, synthetic rubber
- Reinforcement** One braid of high-tensile steel wire
- Temperature** -40°C to 100°C (-40°F to 212°F)
- Standards / Approvals**
 - Meets or exceeds SAE 100R1AT; EN 853 1SN DIN 20022 1SN
 - Meets Higher EN/DIN Pressures / Meets Flame Resistance USMSHA

| PART NUMBER | HOSE SIZE (ID) | WORKING PRESSURE | BURST PRESSURE | MIN BEND RADIUS |
|-------------|----------------|--------------------|---------------------|-----------------|
| R1SN-04 | 1/4" (6.4mm) | 3275 PSI / 225 BAR | 13100 PSI / 900 BAR | 101.6 mm |
| R1SN-06 | 3/8" (9.5mm) | 2600 PSI / 180 BAR | 10400 PSI / 718 BAR | 129.54 mm |
| R1SN-08 | 1/2" (12.7mm) | 2325 PSI / 160 BAR | 9300 PSI / 641 BAR | 177.8 mm |
| R1SN-10 | 5/8" (15.9mm) | 1900 PSI / 131 BAR | 7600 PSI / 524 BAR | 205.74 mm |
| R1SN-12 | 3/4" (19mm) | 1525 PSI / 105 BAR | 6100 PSI / 420 BAR | 241.3 mm |
| R1SN-16 | 1" (25.4mm) | 1250 PSI / 86 BAR | 5000 PSI / 345 BAR | 299.72 mm |

GATES G1 (SAE 100 R1AT - EN 853 1SN)



- Cover** Black, abrasion resistant, synthetic rubber
- Reinforcement** One braid of high-tensile steel wire
- Temperature** -40°C to 100°C (-40°F to 212°F)
- Standards / Approvals**
 - Meets or exceeds SAE 100R1AT; EN 853 1SN DIN 20022 1SN
 - Meets Higher EN/DIN Pressures / Meets Flame Resistance USMSHA

| PART NUMBER | HOSE SIZE (ID) | WORKING PRESSURE | BURST PRESSURE | MIN BEND RADIUS |
|-------------|-----------------|------------------|--------------------|-----------------|
| R1SN-20 | 1-1/4" (31.7mm) | 925 PSI / 63 BAR | 3700 PSI / 255 BAR | 406.4 mm |
| R1SN-24 | 1-1/2" (38.1mm) | 725 PSI / 50 BAR | 2900 PSI / 200 BAR | 508 mm |
| R1SN-32 | 2" (50.8mm) | 600 PSI / 41 BAR | 2400 PSI / 166 BAR | 635 mm |



GATES PRO SERIES CR2 (SAE 100 R2AT - EN 853 2SN)



- Cover** Black, abrasion resistant, synthetic rubber
- Reinforcement** Two braids of high-tensile steel wire
- Temperature** -40°C to 100°C (-40°F to 212°F)
- Standards / Approvals**
 - Meets or exceeds SAE 100R2AT; EN 853 2SN DIN 20022 2SN
 - Meets Higher EN/DIN Pressures / Meets Flame Resistance USMSHA

| PART NUMBER | HOSE SIZE (ID) | WORKING PRESSURE | BURST PRESSURE | MIN BEND RADIUS |
|-------------|----------------|--------------------|----------------------|-----------------|
| R2SN-04 | 1/4" (6.4mm) | 5800 PSI / 400 BAR | 23200 PSI / 1600 BAR | 101.6 mm |
| R2SN-06 | 3/8" (9.5mm) | 4800 PSI / 330 BAR | 19200 PSI / 1320 BAR | 129.54 mm |
| R2SN-08 | 1/2" (12.7mm) | 4000 PSI / 275 BAR | 16000 PSI / 1100 BAR | 177.8 mm |
| R2SN-10 | 5/8" (15.9mm) | 3625 PSI / 250 BAR | 14500 PSI / 1000 BAR | 205.74 mm |
| R2SN-12 | 3/4" (19mm) | 3125 PSI / 215 BAR | 12500 PSI / 850 BAR | 241.3 mm |
| R2SN-16 | 1" (25.4mm) | 2400 PSI / 165 BAR | 9600 PSI / 660 BAR | 299.72 mm |

GATES G2 (SAE 100 R2AT - EN 853 2SN)



- Cover** Black, abrasion resistant, synthetic rubber
- Reinforcement** Two braids of high-tensile steel wire
- Temperature** -40°C to 100°C (-40°F to 212°F)
- Standards / Approvals**
 - Meets or exceeds SAE 100R2AT; EN 853 2SN DIN 20022 2SN
 - Meets Higher EN/DIN Pressures / Meets Flame Resistance USMSHA

| PART NUMBER | HOSE SIZE (ID) | WORKING PRESSURE | BURST PRESSURE | MIN BEND RADIUS |
|-------------|-----------------|--------------------|--------------------|-----------------|
| R2SN-20 | 1-1/4" (31.7mm) | 1825 PSI / 125 BAR | 7300 PSI / 503 BAR | 419.1 mm |
| R2SN-24 | 1-1/2" (38.1mm) | 1300 PSI / 90 BAR | 5200 PSI / 358 BAR | 508 mm |
| R2SN-32 | 2" (50.8mm) | 1175 PSI / 81 BAR | 4700 PSI / 324 BAR | 635 mm |

GATES EFG4K (ISOBARIC 4K PRESSURE)



- Cover** Black, oil resistant, synthetic rubber (Polychloroprene - Type A)
- Reinforcement** Four alternating layers of spiralled high-tensile steel wire
- Temperature** -40°C to 121°C (-40°F to 250°F)
- Standards / Approvals**
- Exceeds ISO 18752 Grade D, SAE 100R12, EN856 R12
 - Meets Flame Resistance USMSHA

| PART NUMBER | HOSE SIZE (ID) | WORKING PRESSURE | BURST PRESSURE | MIN BEND RADIUS |
|-------------|-----------------|--------------------|----------------------|-----------------|
| 4K-06 | 3/8" (9.5mm) | 4000 PSI / 276 BAR | 16000 PSI / 1103 BAR | 63.5 mm |
| 4K-08 | 1/2" (12.7mm) | 4000 PSI / 276 BAR | 16000 PSI / 1103 BAR | 88.9 mm |
| 4K-12 | 3/4" (19mm) | 4000 PSI / 276 BAR | 16000 PSI / 1103 BAR | 119.38 mm |
| 4K-16 | 1" (25.4mm) | 4000 PSI / 276 BAR | 16000 PSI / 1103 BAR | 152.4 mm |
| 4K-20 | 1-1/4" (31.7mm) | 4000 PSI / 276 BAR | 16000 PSI / 1103 BAR | 208.28 mm |

GATES EFG6K (ISOBARIC 6K PRESSURE)



- Cover** Black, oil resistant, synthetic rubber (Polychloroprene - Type A)
- Reinforcement** Four alternating layers of spiralled high-tensile steel wire (-08 to -16)
Six alternating layers of spiralled high-tensile steel wire (-20 to -32)
- Temperature** -40°C to 121°C (-40°F to 250°F)
- Standards / Approvals**
- Exceeds SAE 100R15, EN 856 4SP (-8 to -12), EN 856 4SH (-12 to -20), and ISO 3862 Type R15 (-8 to -24)
 - Meets Flame Resistance USMSHA

| PART NUMBER | HOSE SIZE (ID) | WORKING PRESSURE | BURST PRESSURE | MIN BEND RADIUS |
|-------------|-----------------|--------------------|----------------------|-----------------|
| 6K-06 | 3/8" (9.5mm) | 6000 PSI / 414 BAR | 24000 PSI / 1655 BAR | 63.5 mm |
| 6K-08 | 1/2" (12.7mm) | 6000 PSI / 414 BAR | 24000 PSI / 1655 BAR | 88.9 mm |
| 6K-10 | 5/8" (15.9mm) | 6000 PSI / 414 BAR | 24000 PSI / 1655 BAR | 101.6 mm |
| 6K-12 | 3/4" (19mm) | 6000 PSI / 414 BAR | 24000 PSI / 1655 BAR | 119.38 mm |
| 6K-16 | 1" (25.4mm) | 6000 PSI / 414 BAR | 24000 PSI / 1655 BAR | 152.4 mm |
| 6K-20 | 1-1/4" (31.7mm) | 6000 PSI / 414 BAR | 24000 PSI / 1655 BAR | 208.28 mm |
| 6K-24 | 1-1/2" (38.1mm) | 6000 PSI / 414 BAR | 24000 PSI / 1655 BAR | 254 mm |
| 6K-32 | 2" (50.8mm) | 6000 PSI / 414 BAR | 24000 PSI / 1655 BAR | 635 mm |

SAE 100 R4



| | |
|------------------------------|--|
| Cover | Black synthetic rubber |
| Reinforcement | High tensile textile plies, helix wire embedded. |
| Inner Tube | Black smooth rubber, suitable for hydraulic oils and fuel with aromatic content < 40%. |
| Temperature | -40°C to 100°C |
| Standards / Approvals | ▪ Meets or exceeds SAE 100R4 |

| PART NUMBER | HOSE SIZE (ID) | WORKING PRESSURE | BURST PRESSURE | MIN BEND RADIUS |
|-------------|-----------------|------------------|-------------------|-----------------|
| R4-12 | 3/4" (19mm) | 300 PSI / 21 BAR | 1220 PSI / 84 BAR | 125 mm |
| R4-16 | 1" (25.4mm) | 250 PSI / 17 BAR | 1010 PSI / 70 BAR | 150 mm |
| R4-20 | 1-1/4" (31.7mm) | 200 PSI / 14 BAR | 810 PSI / 56 BAR | 200 mm |
| R4-24 | 1-1/2" (38.1mm) | 140 PSI / 10 BAR | 610 PSI / 42 BAR | 255 mm |
| R4-32 | 2" (50.8mm) | 100 PSI / 7 BAR | 410 PSI / 28 BAR | 300 mm |
| R4-40 | 2-1/2" (63.5mm) | 62 PSI / 4 BAR | 250 PSI / 17 BAR | 355 mm |

SAE 100 R5 – High Temp



| | |
|------------------------------|--|
| Cover | Blue, polyester/textile braid impregnated with rubber |
| Reinforcement | One braid textile, one braid steel |
| Temperature | -40°C to 150°C (-40°F to 302°F) / Air Brake Application: -40°C to 93°C |
| Standards / Approvals | ▪ Meets or exceeds SAE 100R5; SAE J1402 Type All, Dot FMVSS 106 Type All |

| PART NUMBER | HOSE SIZE (ID) | WORKING PRESSURE | BURST PRESSURE | MIN BEND RADIUS |
|-------------|-----------------|--------------------|---------------------|-----------------|
| R5-04 | 3/16" (4.8mm) | 3000 PSI / 207 BAR | 12000 PSI / 828 BAR | 76 mm |
| R5-05 | 1/4" (6.4mm) | 3000 PSI / 207 BAR | 12000 PSI / 828 BAR | 86 mm |
| R5-06 | 5/16" (7.9mm) | 2250 PSI / 155 BAR | 9000 PSI / 620 BAR | 102 mm |
| R5-08 | 13/32" (10.3mm) | 2000 PSI / 139 BAR | 8000 PSI / 556 BAR | 117 mm |
| R5-10 | 1/2" (12.7mm) | 1750 PSI / 121 BAR | 7000 PSI / 484 BAR | 140 mm |
| R5-12 | 5/8" (15.9mm) | 1500 PSI / 103 BAR | 6000 PSI / 412 BAR | 165 mm |
| R5-16 | 7/8" (22.2mm) | 800 PSI / 55 BAR | 3200 PSI / 220 BAR | 187 mm |

SAE 100 R6 - EN 854

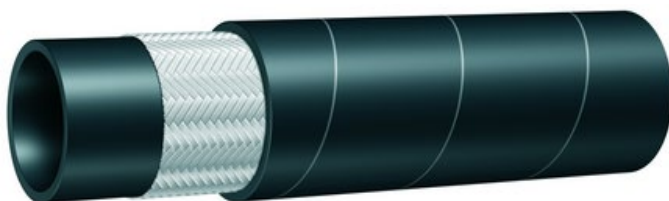

Cover Black synthetic rubber
Reinforcement One braid of textile plies
Temperature -40°C to 120°C
Standards / Approvals ▪ Meets or exceeds SAE 100R6; EN 854

| PART NUMBER | HOSE SIZE (ID) | WORKING PRESSURE | BURST PRESSURE | MIN BEND RADIUS |
|-------------|----------------|------------------|--------------------|-----------------|
| R6-04 | 1/4" (6.4mm) | 400 PSI / 28 BAR | 1600 PSI / 110 BAR | 64 mm |
| R6-06 | 3/8" (9.5mm) | 400 PSI / 28 BAR | 1600 PSI / 110 BAR | 76 mm |
| R6-08 | 1/2" (12.7mm) | 400 PSI / 28 BAR | 1600 PSI / 110 BAR | 102 mm |
| R6-10 | 5/8" (15.9mm) | 350 PSI / 24 BAR | 1400 PSI / 97 BAR | 127 mm |
| R6-12 | 3/4" (19mm) | 300 PSI / 21 BAR | 1200 PSI / 83 BAR | 152 mm |
| R6-16 | 1" (25.4mm) | 190 PSI / 13 BAR | 760 PSI / 52 BAR | 230 mm |

GATES LOLA PUSH LOCK



Cover Black Polychloroprene synthetic rubber
Reinforcement One braid of fiber braid
Temperature -40°C to 100°C (-40°F to 212°F)
Standards / Approvals ▪ Meets Flame Resistance MSHA 2G

| PART NUMBER | HOSE SIZE (ID) | WORKING PRESSURE | BURST PRESSURE | MIN BEND RADIUS |
|-------------|----------------|------------------|-------------------|-----------------|
| LOLA-04 | 1/4" (6.4mm) | 300 PSI / 21 BAR | 1200 PSI / 83 BAR | 76 mm |
| LOLA-05 | 5/16" (8mm) | 300 PSI / 21 BAR | 1200 PSI / 83 BAR | 76 mm |
| LOLA-06 | 3/8" (9.5mm) | 300 PSI / 21 BAR | 1200 PSI / 83 BAR | 76 mm |
| LOLA-08 | 1/2" (12.7mm) | 300 PSI / 21 BAR | 1200 PSI / 83 BAR | 127 mm |
| LOLA-10 | 5/8" (15.9mm) | 300 PSI / 21 BAR | 1200 PSI / 83 BAR | 152 mm |
| LOLA-12 | 3/4" (19mm) | 300 PSI / 21 BAR | 1200 PSI / 83 BAR | 177 mm |

Multipurpose



| | |
|----------------------|--|
| Cover | Red smooth extruded rubber |
| Reinforcement | Braided synthetic cord |
| Inner Tube | Black smooth Nitrile rubber, resistant to 55% aromatic content Electronically non-conductive (Alcoa approved) |
| Temperature | -25°C to 100°C |

| PART NUMBER | HOSE SIZE (ID) | WORKING PRESSURE | BURST PRESSURE |
|-------------|----------------|------------------|------------------|
| RMP-04 | 6mm | 290 PSI / 20 BAR | 870 PSI / 60 BAR |
| RMP-05 | 8mm | 290 PSI / 20 BAR | 870 PSI / 60 BAR |
| RMP-06 | 10mm | 290 PSI / 20 BAR | 870 PSI / 60 BAR |
| RMP-08 | 12mm | 290 PSI / 20 BAR | 870 PSI / 60 BAR |
| RMP-10 | 16mm | 290 PSI / 20 BAR | 870 PSI / 60 BAR |
| RMP-12 | 19mm | 290 PSI / 20 BAR | 870 PSI / 60 BAR |
| RMP-16 | 25mm | 290 PSI / 20 BAR | 870 PSI / 60 BAR |

SAE 100 R14 PTFE Stainless Steel

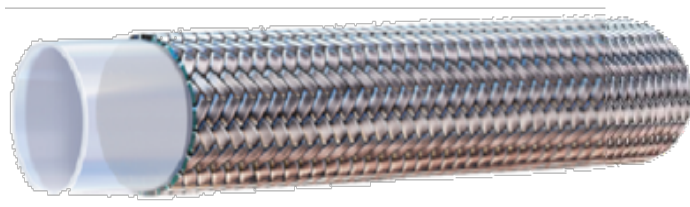

| | |
|------------------------------|--|
| Cover | 1 Braid of 303/304 Stainless Steel Wire |
| Inner Tube | PTFE - Polytetrafluoroethylene |
| Temperature | -54°C to 260°C |
| Standards / Approvals | <ul style="list-style-type: none"> ▪ Meets or exceeds SAE 100 R14A; FDA 21 CFR 177, 1500 Specifications ▪ High Temperature ▪ Chemical Resistant |

| PART NUMBER | HOSE SIZE (ID) | WORKING PRESSURE | BURST PRESSURE | MIN BEND RADIUS |
|-------------|----------------|--------------------|---------------------|-----------------|
| R14-04 | 1/4" (6.4mm) | 2537 PSI / 175 BAR | 10150 PSI / 700 BAR | 45 mm |
| R14-06 | 3/8" (9.5mm) | 1957 PSI / 135 BAR | 7830 PSI / 540 BAR | 55 mm |
| R14-08 | 1/2" (12.7mm) | 1740 PSI / 120 BAR | 6960 PSI / 480 BAR | 70 mm |
| R14-10 | 5/8" (15.9mm) | 1450 PSI / 100 BAR | 5800 PSI / 400 BAR | 130 mm |
| R14-12 | 3/4" (19mm) | 1305 PSI / 90 BAR | 5220 PSI / 360 BAR | 190 mm |
| R14-16 | 1" (25.4mm) | 942 PSI / 65 BAR | 3770 PSI / 260 BAR | 270 mm |

GATES CLEAN MASTER (Pressure Wash 2 Wire)



| | |
|------------------------------|--|
| Cover | Non-marking blue, abrasion resistant, synthetic rubber |
| Reinforcement | Two braids of high-tensile steel wire |
| Temperature | -40°C to 121°C (-40°F to 250°F) |
| Standards / Approvals | ▪ Meets or exceeds EN1829-2 |

| PART NUMBER | HOSE SIZE (ID) | WORKING PRESSURE | BURST PRESSURE | MIN BEND RADIUS |
|-------------|----------------|--------------------|----------------------|-----------------|
| R2PW-06 | 3/8" (9.5mm) | 6000 PSI / 415 BAR | 18000 PSI / 1242 BAR | 63.5 mm |

GATES M3K (SAE 100 R17)



| | |
|------------------------------|---|
| Cover | Black, abrasion resistant, synthetic rubber |
| Reinforcement | One braid of high-tensile steel wire (-04 to -8) Two braids of high-tensile steel wire (-10 to -16) |
| Temperature | -40°C to 100°C (-40°F to 212°F) |
| Standards / Approvals | ▪ Meets or exceeds SAE 100R17; ISO 18752 Grade B; ISO 11237 R17 ▪ Meets Flame Resistance USMSHA ▪ Meets minimum bend radius of EN 857 1SC |

| PART NUMBER | HOSE SIZE (ID) | WORKING PRESSURE | BURST PRESSURE | MIN BEND RADIUS |
|-------------|----------------|--------------------|---------------------|-----------------|
| R17-04 | 1/4" (6.4mm) | 3275 PSI / 225 BAR | 13000 PSI / 896 BAR | 38.1 mm |
| R17-06 | 3/8" (9.5mm) | 3275 PSI / 225 BAR | 13000 PSI / 896 BAR | 50.8 mm |
| R17-08 | 1/2" (12.7mm) | 3275 PSI / 225 BAR | 13000 PSI / 896 BAR | 71.12 mm |
| R17-10 | 5/8" (15.9mm) | 3275 PSI / 225 BAR | 13000 PSI / 896 BAR | 76.6 mm |
| R17-12 | 3/4" (19mm) | 3275 PSI / 225 BAR | 13000 PSI / 896 BAR | 96.52 mm |
| R17-16 | 1" (25.4mm) | 3275 PSI / 225 BAR | 13000 PSI / 896 BAR | 114.3 mm |

The background of the page is a dark red color. Overlaid on this is a technical drawing of a hose assembly, rendered in a lighter red color. The drawing shows a hose with a gauge attached to one end. The drawing uses solid lines for the main components and dashed lines for hidden or internal parts, indicating a 3D perspective view. The hose is shown in a curved, S-like shape, with the gauge positioned at the top left and the other end of the hose extending towards the bottom right. The overall style is that of a technical manual or catalog page.

GAUGES & TEST HOSES

Pressure Gauges

2.5" Gauges Bottom Entry – 1/4" BSPP

| | |
|-----------|-----------|
| PG63B-10 | 0-10 Bar |
| PG63B-16 | 0-16 Bar |
| PG63B-25 | 0-25 Bar |
| PG63B-40 | 0-40 Bar |
| PG63B-60 | 0-60 Bar |
| PG63B-100 | 0-100 Bar |
| PG63B-160 | 0-160 Bar |
| PG63B-250 | 0-250 Bar |
| PG63B-315 | 0-315 Bar |
| PG63B-400 | 0-400 Bar |
| PG63B-600 | 0-600 Bar |
| PG63B-700 | 0-700 Bar |



2.5" Digital Gauges Bottom Entry – 1/4" BSPP

| | |
|------------|-----------|
| PG63B-100D | 0-100 Bar |
| PG63B-400D | 0-400 Bar |
| PG63B-700D | 0-700 Bar |



4.0" Gauges Bottom Entry – 1/2" BSPP

| | |
|------------|-----------|
| PG100B-10 | 0-10 Bar |
| PG100B-16 | 0-16 Bar |
| PG100B-25 | 0-25 Bar |
| PG100B-40 | 0-40 Bar |
| PG100B-60 | 0-60 Bar |
| PG100B-100 | 0-100 Bar |
| PG100B-160 | 0-160 Bar |
| PG100B-250 | 0-250 Bar |
| PG100B-315 | 0-315 Bar |
| PG100B-400 | 0-400 Bar |
| PG100B-600 | 0-600 Bar |
| PG100B-700 | 0-700 Bar |



Pressure Gauge Kit

PGK-2 (CBOXMEDS1-M)

| Kit Includes: | Description |
|------------------------|-------------------------|
| Pressure Gauges x 2 | Your Choice |
| Test Hose | Test 20 x 2m |
| Direct Gauge Connector | 1/4"- Male Test 20 |
| Direct Gauge Connector | 1/4"- Female Test 20 |
| Test Point | 1/4" BSPP |
| Test Point | 1/4"-18 NPTF |
| Test Point | M8x1 |
| Test Point | M14x1.5 |
| Test Point | 7/16"-20 UNF |
| Reducing Adaptor | M10x1F - M ISO228 G3/8" |
| Reducing Adaptor | M10x1F - M ISO228 G1/2" |
| Anti-Shock Valve | 90 Deg Entry |
| Anti-Shock Valve | Swivel Direct Entry |



PGK-1D (CBOXMEDDS)

| Kit Includes: | Description |
|------------------------|-------------------------|
| Digital Gauge | 700 Bar |
| Test Hose | Test 20 x 2m |
| Direct Gauge Connector | 1/4"- Male Test 20 |
| Direct Gauge Connector | 1/4"- Female Test 20 |
| Test Point | 1/4" BSPP |
| Test Point | 1/4"-18 NPTF |
| Test Point | M8x1 |
| Test Point | M14x1.5 |
| Test Point | 7/16"-20 UNF |
| Reducing Adaptor | M10x1F - M ISO228 G3/8" |
| Reducing Adaptor | M10x1F - M ISO228 G1/2" |
| Anti-Shock Valve | 90 Deg Entry |
| Anti-Shock Valve | Swivel Direct Entry |



PGK-3 (CBOXMED3)

| Kit Includes: | Description |
|----------------------|--------------------------|
| Pressure Gauge x 3 | 40 Bar, 160 Bar, 300 Bar |
| Test Hose | 1 x 2m |
| Gauge Adaptor x 3 | Test 20 |



Test Hose & Fittings

Hose



| PART NUMBER | HOSE SIZE (ID) | HOSE SIZE (OD) | WORKING PRESSURE | BURST PRESSURE | BEND RADIUS | TEMP |
|-------------|----------------|----------------|------------------|----------------|-------------|-------------|
| T2H-01 | 2mm | 5mm | 630 Bar | 1890 Bar | 20 mm | -40 / +100c |

Ferrule – T2H Hose

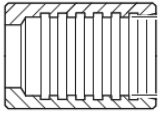
| PART NUMBER | TYPE | MATERIAL | MAX PRESSURE | |
|-------------|------|----------|--------------|---|
| TSF-01 | RD2 | Steel | 600 Bar |  |

Tails – T2H Hose

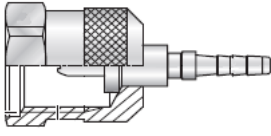
| PART NUMBER | THREAD | TYPE | |
|------------------|--------|----------|--|
| TST-T20-0116 | M16X2 | Straight |  Test 20 Coupling |
| TST-T20-45S-0116 | | 45 Deg | |
| TST-T20-90S-0116 | | 90 Deg | |

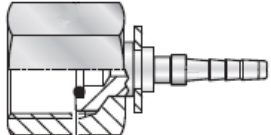
| | | | |
|------------------|-----------|----------|---|
| TST-BGF-0104 | 1/4 Gauge | Straight |  Gauges Threaded Fitting |
| TST-BGF-0108 | 1/2 Gauge | | |
| TST-BGF-45S-0104 | 1/4 Gauge | 45 Deg | |
| TST-BGF-45S-0108 | 1/2 Gauge | | |
| TST-BGF-90S-0104 | 1/4 Gauge | 90 Deg | |
| TST-BGF-90S-0108 | 1/2 Gauge | | |

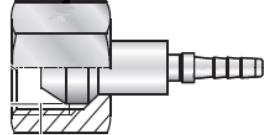
| | | | |
|------------------|------------|----------|--|
| TST-BSF-0102 | 1/8 BSPPFS | Straight |  60° Cone Connection Type BSP |
| TST-BSF-0104 | 1/4 BSPPFS | | |
| TST-BSF-0106 | 3/8 BSPPFS | | |
| TST-BSF-45S-0102 | 1/8 BSPPFS | 45 Deg | |
| TST-BSF-45S-0104 | 1/4 BSPPFS | | |
| TST-BSF-90S-0102 | 1/8 BSPPFS | 90 Deg | |
| TST-BSF-90S-0104 | 1/4 BSPPFS | | |

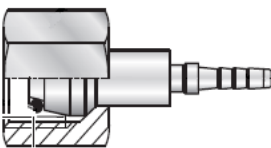
| PART NUMBER | Size | Type |  24° Cone Connection Type DKOL |
|------------------|---------|----------|---|
| TST-MLF-0112 | M12x1.5 | Straight | |
| TST-MLF-0114 | M14x1.5 | | |
| TST-MLF-0116 | M16x1.5 | | |
| TST-MLF-0118 | M18x1.5 | | |
| TST-MLF-45S-0112 | M12x1.5 | 45 Deg | |
| TST-MLF-45S-0114 | M14x1.5 | | |
| TST-MLF-45S-0116 | M16x1.5 | | |
| TST-MLF-90S-0112 | M12x1.5 | 90 Deg | |
| TST-MLF-90S-0114 | M14x1.5 | | |
| TST-MLF-90S-0116 | M16x1.5 | | |

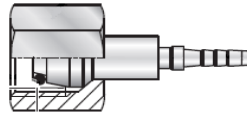
| | | | |
|-------------------|-------|----------|--|
| TST-MLLF-0108 | M8X1 | Straight |  24° Cone Connection Type DKOLL |
| TST-MLLF-0110 | M10X1 | | |
| TST-MLLF-45S-0110 | M10X1 | 45 Deg | |
| TST-MLLF-90S-0110 | M10X1 | 90 Deg | |

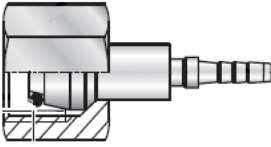
| | | | |
|------------------|---------|----------|---|
| TST-MHF-0114 | M14x1.5 | Straight |  24° Cone Connection Type DKOS |
| TST-MHF-0116 | M16x1.5 | | |
| TST-MHF-0118 | M18x1.5 | | |
| TST-MHF-0120 | M20x1.5 | | |
| TST-MHF-45S-0114 | M14x1.5 | 45 Deg | |
| TST-MHF-45S-0116 | M16x1.5 | | |
| TST-MHF-45S-0118 | M18x1.5 | | |
| TST-MHF-90S-0114 | M14x1.5 | 90 Deg | |
| TST-MHF-90S-0116 | M16x1.5 | | |
| TST-MHF-90S-0118 | M18x1.5 | | |

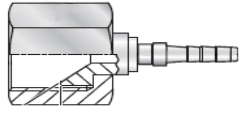
| | | | |
|------------------|---------------|----------|---|
| TST-JIF-0107 | 7/16-20 JICFS | Straight |  JIC 74° Connection Type DKJ |
| TST-JIF-0109 | 9/16-18 JICFS | | |
| TST-JIF-45S-0107 | 7/16-20 JICFS | 45 Deg | |
| TST-JIF-90S-0107 | 7/16-20 JICFS | 90 Deg | |

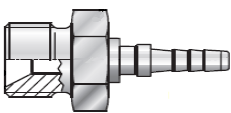
| | | | |
|--------------|-----------|----------|---|
| TST-BPM-0102 | 1/8 BSPPM | Straight |  60° Cone Connection Type BSPP |
| TST-BPM-0104 | 1/4 BSPPM | | |

| | | | |
|--------------|-----------|----------|--|
| TST-BTM-0102 | 1/8 BSPTM | Straight |  BSPT |
| TST-BTM-0104 | 1/4 BSPTM | | |

Test Point Adaptors

BSPP Gauge Fixed Female x Test 20 Female Swivel

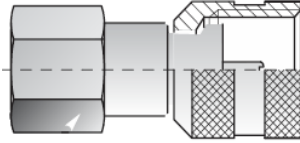

| | |
|---------------|-----------------------|
| BGF-TEST-0420 | 1/4 BSPPF x TEST 20 F |
|---------------|-----------------------|

BSPP Male x BSPP Gauge Female Swivel

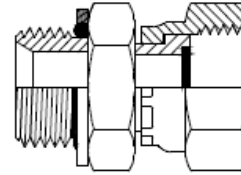

| | |
|--------------|------------------------|
| BGF-BPM-0402 | 1/4 BSPPFS x 1/8 BSPPM |
| BGF-BPM-0404 | 1/4 BSPPFS x 1/4 BSPPM |
| BGF-BPM-0808 | 1/2 BSPPFS x 1/2 BSPPM |

BSPP Male x Test 20 Male

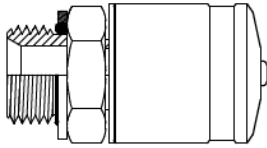

| | |
|---------------|-----------------------|
| BPM-TEST-0220 | 1/8 BSPPM x TEST 20 M |
| BPM-TEST-0420 | 1/4 BSPPM x TEST 20 M |
| BPM-TEST-0620 | 3/8 BSPPM x TEST 20 M |
| BPM-TEST-0820 | 1/2 BSPPM x TEST 20 M |

BSPT Male x BSPP Gauge Female Swivel

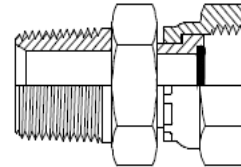

| | |
|--------------|------------------------|
| BGF-BTM-0402 | 1/4 BSPPFS x 1/8 BSPTM |
| BGF-BTM-0404 | 1/4 BSPPFS x 1/4 BSPTM |

BSPT Male x Test 20 Male

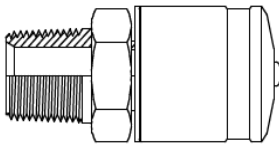

| | |
|---------------|-----------------------|
| BTM-TEST-0220 | 1/8 BSPTM x TEST 20 M |
| BTM-TEST-0420 | 1/4 BSPTM x TEST 20 M |

UNO Male x Test 20 Male

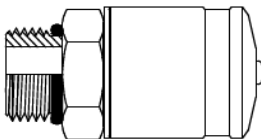

| | |
|---------------|-----------------------|
| UNM-TEST-0720 | 7/16 UNOM x TEST 20 M |
|---------------|-----------------------|

The background of the image is a dark blue-grey color. It features a faint, light-colored technical drawing of hydraulic couplings. The drawing shows two cylindrical components, likely couplings, with various internal and external features such as grooves, flanges, and ports. The lines are thin and light, creating a subtle watermark effect behind the main text.

HYDRAULIC COUPLINGS

Quick Release Couplings

CROSS REFERENCE SHEET

| AUSSIE ADAPTORS | FASTER | DNP | AEROQUIP | CEJN | HANSEN | PARKER | SAFEWAY |
|-----------------|---------|-----|----------|------|----------|----------|---------|
| RQRA | ANV | PAV | 5600 | X95 | HA 15000 | 6600 | S56 |
| RQRS | NS | PDS | | | | 4000 | S40 |
| RQRV | NV | PDV | | | | 4000 | S20-P |
| RQRB | H | PBV | FD45 | X75 | HK | H | S10 |
| RQRS-PP | PS | PPS | | | | 4200 | S40 |
| RQRA-PP | PV | PPV | | | | 4200 | S40 |
| RQFF | FFI/FFJ | PLT | FD49 | X62 | QA29000 | FE-FF3/8 | FF49 |
| RQRJ | PVVM | PVM | | | WA56000 | 3000 | S30 |
| RQRA-PC | 3NV | PKK | | | | | |
| RQRT | | | | 525 | | T | |
| RQFF-PC | 3FFI | PLK | | | | | |
| RQPBR | NZ | | | | | | |

| AUSSIE ADAPTORS | RYCO | STUCCHI | FLUID CONNECTORS | SNAPTITE | PIRTEK |
|-----------------|------------|---------|------------------|----------|-----------|
| RQRA | RA80/81/82 | BIR | QRM/F-BPF | 61 | 6600 |
| RQRS | R91 | IR | | 21 | 4000B |
| RQRV | RA80/81/82 | IRV | ORM/F-DIN | 60 | 4000 |
| RQRB | | IRB | QRM/F-BPF**B | 72 | 60B/F6600 |
| RQRS-PP | R91**P | IRS12A | | 61 | |
| RQRA-PP | RA81**P | IRS12VA | QRF-PC-BPF | | 6602P |
| RQFF | R110 | FIRG | QFM/F-BPF-HD | 74 | 7000/7500 |
| RQRJ | R100 | IVHP | QJM/F-NTM/F | 76 | 3000 |
| RQRA-PC | R81-CPM | BIR*PC | QRM/F-BPF-PC | 68/63 | |
| RQRT | R130 | IRH | QRM/F-TEM | | |
| RQFF-PC | | APM | QFM BPF-PC | | |
| RQPBR | | IRN | QRM/F-PBR | | |

This cross reference is intended as a reference only. It is up to the customer to confirm that different manufacturers couplers will match. Please confirm before ordering.

ISO A

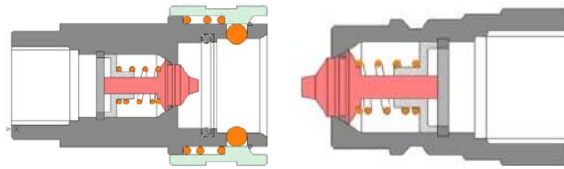

RQRA ISO A COUPLER

| FEMALE | THREAD | MALE | THREAD |
|-----------|-------------|-----------|-------------|
| RQRA-F-04 | 1/4" BSPF | RQRA-M-04 | 1/4" BSPF |
| RQRA-F-06 | 3/8" BSPF | RQRA-M-06 | 3/8" BSPF |
| RQRA-F-08 | 1/2" BSPF | RQRA-M-08 | 1/2" BSPF |
| RQRA-F-12 | 3/4" BSPF | RQRA-M-12 | 3/4" BSPF |
| RQRA-F-16 | 1" BSPF | RQRA-M-16 | 1" BSPF |
| RQRA-F-20 | 1.1/4" BSPF | RQRA-M-20 | 1.1/4" BSPF |

RQRA-PP ISO A PUSH PULL COUPLER

| FEMALE | THREAD |
|--------------|-----------|
| RQRA-PP-F-08 | 1/2" BSPF |



Dust Caps & Plugs

| CAP | PLUG |
|---------|---------|
| RQAC-04 | RQAP-04 |
| RQAC-06 | RQAP-06 |
| RQAC-08 | RQAP-08 |
| RQAC-12 | RQAP-12 |
| RQAC-16 | RQAP-16 |

TECHNICAL INFORMATION

STANDARD: ISO 7241-1 A (ISO A) POPPET

MATERIAL: STEEL, Zn-Fe (CRIII) FINISH. ALSO AVAILABLE IN 316 STAINLESS STEEL

SEALS: NBR STANDARD, OTHER AVAILABLE ON REQUEST

WORKING TEMP: -25°C +100°C

| PART No. | MAX WORKING | FLOW RATE L/M | MAX FLOW L/M |
|----------|-------------|---------------|--------------|
| RQRA-04 | 350 BAR | 12 | 24 |
| RQRA-06 | 350 BAR | 23 | 46 |
| RQRA-08 | 250 BAR | 45 | 90 |
| RQRA-12 | 250 BAR | 106 | 220 |
| RQRA-16 | 200 BAR | 189 | 260 |
| RQRA-20 | 200 BAR | 288 | 480 |
| RQRA-24 | 190 BAR | 379 | 757 |
| RQRA-32 | 160 BAR | 757 | 1000 |

ISO B

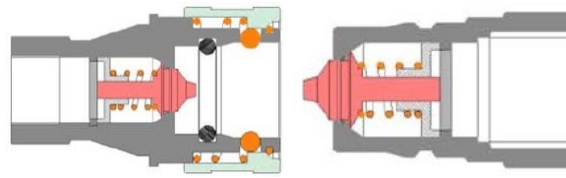

RQRB ISO B COUPLER

| FEMALE | THREAD | MALE | THREAD |
|-----------|-----------|-----------|-----------|
| RQRB-F-04 | 1/4" BSPF | RQRB-M-04 | 1/4" BSPF |
| RQRB-F-06 | 3/8" BSPF | RQRB-M-06 | 3/8" BSPF |
| RQRB-F-08 | 1/2" BSPF | RQRB-M-08 | 1/2" BSPF |
| RQRB-F-12 | 3/4" BSPF | RQRB-M-12 | 3/4" BSPF |
| RQRB-F-16 | 1" BSPF | RQRB-M-16 | 1" BSPF |

Dust Caps & Plugs

| CAP | PLUG |
|---------|---------|
| RQBC-04 | RQBP-04 |
| RQBC-06 | RQBP-06 |
| RQBC-08 | RQBP-08 |
| RQBC-12 | RQBP-12 |
| RQBC-16 | RQBP-16 |

TECHNICAL INFORMATION

STANDARD: ISO 7241-1 B POPPET

MATERIAL: STEEL, Zn-Fe (CRIII) FINISH. ALSO AVAILABLE IN BRASS & 316 STAINLESS STEEL

SEALS: NBR STANDARD, OTHER AVAILABLE ON REQUEST

WORKING TEMP: -25°C +100°C

| PART No. | MAX WORKING | FLOW RATE L/M | MAX FLOW L/M |
|----------|-------------|---------------|--------------|
| RQRB-04 | 250 BAR | 12 | 24 |
| RQRB-06 | 250 BAR | 23 | 46 |
| RQRB-08 | 250 BAR | 45 | 90 |
| RQRB-12 | 250 BAR | 106 | 220 |
| RQRB-16 | 200 BAR | 189 | 260 |
| RQRB-24 | 63 BAR | 379 | 757 |
| RQRB-32 | 50 BAR | 757 | 1000 |

ISO 7241 Poppet

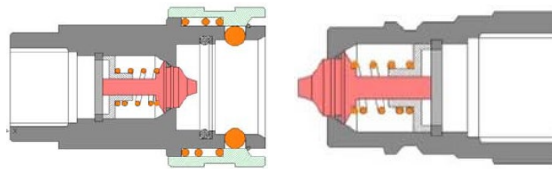

RQRV ISO 7241 COUPLER

| FEMALE | THREAD | | MALE | THREAD | |
|------------------|-----------|--|------------------|-----------|--|
| RQRV-F-04 | 1/4" BSPF | | RQRV-M-04 | 1/4" BSPF | |
| RQRV-F-06 | 3/8" BSPF | | RQRV-M-06 | 3/8" BSPF | |
| RQRA-F-08 | 1/2" BSPF | | RQRA-M-08 | 1/2" BSPF | |
| RQRV-F-12 | 3/4" BSPF | | RQRV-M-12 | 3/4" BSPF | |
| RQRV-F-16 | 1" BSPF | | RQRV-M-16 | 1" BSPF | |

USE PART NUMBER RQRA WHEN ORDERING 1/2" COUPLERS

| | | | | | |
|-----------|-----------|--|-----------|-----------|--|
| RQNV-F-12 | 3/4" BSPF | | RQNV-M-12 | 3/4" BSPF | |
|-----------|-----------|--|-----------|-----------|--|

FASTER "NV34" SERIES INTERCHANGE

Dust Caps & Plugs

| CAP | | PLUG | |
|---------|--|---------|--|
| RQVC-04 | | RQVP-04 | |
| RQVC-06 | | RQVP-06 | |
| RQAC-08 | | RQAP-08 | |
| RQVC-12 | | RQVP-12 | |
| RQVC-16 | | RQVP-16 | |

TECHNICAL INFORMATION

STANDARD: ISO 7241 POPPET

MATERIAL: STEEL, Zn-Fe (CRIII) FINISH. ALSO AVAILABLE IN 316 STAINLESS STEEL

SEALS: NBR STANDARD, OTHER AVAILABLE ON REQUEST

WORKING TEMP: -25°C +100°C

| PART No. | MAX WORKING | FLOW RATE L/M | MAX FLOW L/M |
|----------|-------------|---------------|--------------|
| RQRV-04 | 350 BAR | 12 | 24 |
| RQRV-06 | 350 BAR | 23 | 46 |
| RQRA-08 | 250 BAR | 45 | 90 |
| RQRV-12 | 250 BAR | 106 | 190 |
| RQRV-16 | 200 BAR | 180 | 250 |
| RQRV-20 | 200 BAR | 288 | 480 |
| RQRV-24 | 190 BAR | 379 | 700 |
| RQRV-32 | 160 BAR | 757 | 1000 |

ISO 7241 Ball Type

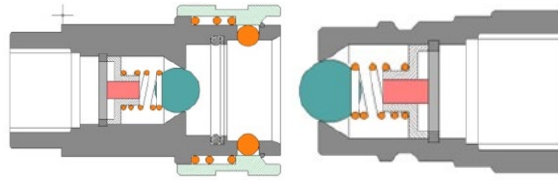

RQRS ISO 7241 BALL TYPE COUPLER

| FEMALE | THREAD | MALE | THREAD |
|-----------|-----------|-----------|-----------|
| RQRS-F-04 | 1/4" BSPF | RQRS-M-04 | 1/4" BSPF |
| RQRS-F-06 | 3/8" BSPF | RQRS-M-06 | 3/8" BSPF |
| RQRS-F-08 | 1/2" BSPF | RQRS-M-08 | 1/2" BSPF |

RQRS-PP BALL PUSH PULL COUPLER

| FEMALE | THREAD |
|--------------|-----------|
| RQRS-PP-F-08 | 1/2" BSPF |



Dust Caps & Plugs

| CAP | PLUG |
|---------|---------|
| RQVC-04 | RQVP-04 |
| RQVC-06 | RQVP-06 |
| RQAC-08 | RQAP-08 |
| RQVC-12 | RQVP-12 |
| RQVC-16 | RQVP-16 |

TECHNICAL INFORMATION

STANDARD: ISO 7241 BALL

MATERIAL: STEEL, Zn-Fe (CRIII) FINISH

SEALS: NBR STANDARD, OTHER AVAILABLE ON REQUEST

WORKING TEMP: -25°C +100°C

| PART No. | MAX WORKING | FLOW RATE L/M | MAX FLOW L/M |
|----------|-------------|---------------|--------------|
| RQRS-04 | 300 BAR | 12 | 20 |
| RQRS-06 | 250 BAR | 23 | 35 |
| RQRS-08 | 200 BAR | 30 | 55 |
| RQRS-12 | 200 BAR | 60 | 120 |
| RQRS-16 | 200 BAR | 80 | 160 |

ISO 16028 Flat Face

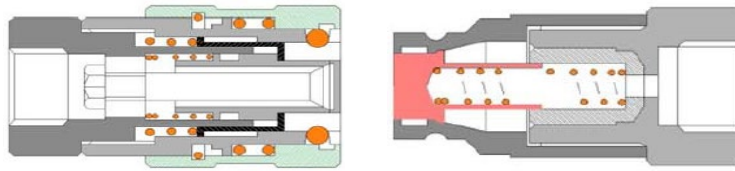

RQFF

ISO 16028 FLAT FACE

| FEMALE | THREAD | MALE | THREAD |
|---------------|-------------|---------------|-------------|
| RQFF-F-0404 | 1/4" BSPF | RQFF-M-0404 | 1/4" BSPF |
| RQFF-F-0606 | 3/8" BSPF | RQFF-M-0606 | 3/8" BSPF |
| RQFF-F-0608 | 1/2" BSPF | RQFF-M-0608 | 1/2" BSPF |
| RQFF-F-0808 | 1/2" BSPF | RQFF-M-0808 | 1/2" BSPF |
| RQFF-F-0812 | 3/4" BSPF | RQFF-M-0812 | 3/4" BSPF |
| RQFF-F-0812UN | 3/4" UNOF | RQFF-M-0812UN | 3/4" UNOF |
| RQFF-F-0814UN | 7/8" UNOF | RQFF-M-0814UN | 7/8" UNOF |
| RQFF-F-1012 | 3/4" BSPF | RQFF-M-1012 | 3/4" BSPF |
| RQFF-F-1212 | 3/4" BSPF | RQFF-M-1212 | 3/4" BSPF |
| RQFF-F-1216 | 1" BSPF | RQFF-M-1216 | 1" BSPF |
| RQFF-F-1616 | 1" BSPF | RQFF-M-1616 | 1" BSPF |
| RQFF-F-1620 | 1-1/4" BSPF | RQFF-M-1620 | 1-1/4" BSPF |

TECHNICAL INFORMATION

STANDARD: ISO 16028 FLAT FACE

MATERIAL: STEEL, Zn-Fe (CRIII) FINISH. ALSO AVAILABLE IN 316 STAINLESS STEEL

SEALS: NBR STANDARD, OTHER AVAILABLE ON REQUEST

WORKING TEMP: -25°C +100°C

| PART No. | MAX WORKING | FLOW RATE L/M | MAX FLOW L/M |
|----------|-------------|---------------|--------------|
| RQFF-04 | 300 BAR | 12 | 24 |
| RQFF-06 | 250 BAR | 23 | 46 |
| RQFF-08 | 250 BAR | 45 | 90 |
| RQFF-10 | 350 BAR | 74 | 150 |
| RQFF-12 | 250 BAR | 100 | 200 |
| RQFF-16 | 250 BAR | 189 | 280 |
| RQFF-24 | 250 BAR | 379 | 700 |
| RQFF-32 | 250 BAR | 757 | 1000 |

Jacking & PBR

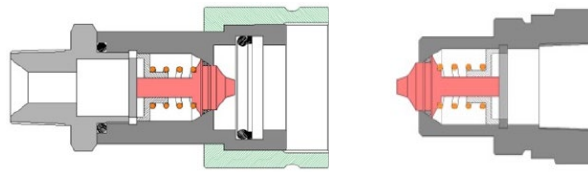

RQRJ JACKING COUPLER

| FEMALE | THREAD | MALE | THREAD |
|------------|-----------|------------|-----------|
| RQRJ-F-04N | 1/4" NPTM | RQRJ-M-04N | 1/4" NPTF |
| RQRJ-F-06N | 3/8" NPTM | RQRJ-M-06N | 3/8" NPTF |

Dust Caps & Plugs

| CAP | PLUG |
|---------|---------|
| RQJC-04 | RQJP-04 |
| RQJC-06 | RQJP-06 |

TECHNICAL INFORMATION

STANDARD: JACKING

MATERIAL: STEEL, Zn-Fe (CRIII) FINISH

SEALS: NBR STANDARD, OTHER AVAILABLE ON REQUEST

WORKING TEMP: -25°C +100°C

| PART No. | MAX WORKING | FLOW RATE L/M | MAX FLOW L/M |
|----------|-------------|---------------|--------------|
| RQRJ-04 | 700 BAR | 5 | 10 |
| RQRJ-06 | 1000 BAR | 10 | 20 |

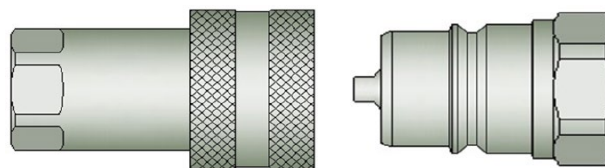

RQPBR PBR TRUCK COUPLER

| FEMALE | THREAD | MALE | THREAD |
|------------|---------|------------|---------|
| RQPBR-F-16 | 1" BSPF | RQPBR-M-16 | 1" BSPF |

TECHNICAL INFORMATION

STANDARD: PBR INTERCHANGE

MATERIAL: STEEL, PASSIVATION FINISH

SEALS: NBR

WORKING TEMP: -20°C +100°C

| PART No. | MAX WORKING | FLOW RATE L/M |
|----------|-------------|---------------|
| RQPBR-16 | 241 | 283 |

Email | sales@aussieadaptors.com Phone | (03) 9768 3301

Prices subject to change without notice

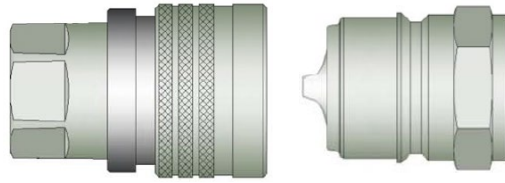

RQRT TEMA INTERCHANGE COUPLER

| FEMALE | THREAD | | MALE | THREAD | |
|-----------|-----------|--|-----------|-----------|--|
| RQRT-F-06 | 3/8" BSPF | | RQRT-M-06 | 3/8" BSPF | |
| RQRT-F-08 | 1/2" BSPF | | RQRT-M-08 | 1/2" BSPF | |
| RQRT-F-12 | 3/4" BSPF | | RQRT-M-12 | 3/4" BSPF | |
| RQRT-F-16 | 1" BSPF | | RQRT-M-16 | 1" BSPF | |

Dust Caps & Plugs

| CAP | | PLUG | |
|---------|--|---------|--|
| RQTC-16 | | RQTP-16 | |

TECHNICAL INFORMATION

STANDARD: TEMA INTERCHANGE

MATERIAL: STEEL, PASSIVATION FINISH. ALSO AVAILABLE IN 316 STAINLESS STEEL

SEALS: NBR STANDARD, OTHER AVAILABLE ON REQUEST

WORKING TEMP: -30°C +100°C

| PART No. | MAX WORKING PRESS BAR | RATED FLOW L/M |
|----------|-----------------------|----------------|
| RQRT-04 | 450 | 29 |
| RQRT-06 | 350 | 69 |
| RQRT-08 | 300 | 122 |
| RQRT-12 | 280 | 250 |
| RQRT-16 | 250 | 425 |